

# Airman Knowledge Testing Supplement for Instrument Rating



U.S. Department of Transportation  
Federal Aviation Administration

NO. = Aircraft position and direction of flight

DISPLACED THRESHOLD

Outflow

*This publication was formerly known as:  
"Computer Testing Supplement for Instrument Rating."*

**DO NOT MARK IN THIS BOOK**



# Airman Knowledge Testing Supplement for Instrument Rating

# 2017

U.S. Department of Transportation  
**FEDERAL AVIATION ADMINISTRATION**  
Flight Standards Service



# Preface

This Airman Knowledge Testing Supplement is designed by the Federal Aviation Administration (FAA) Flight Standards Service. It is intended for use by Airman Knowledge Testing (AKT) Organization Designation Authorization (ODA) Holders and other entities approved and/or authorized to administer airman knowledge tests on behalf of the FAA in the following knowledge areas:

Instrument Rating—Airplane (IRA)  
Instrument Rating—Rotorcraft/Helicopter (IRH)  
Instrument Rating—Powered Lift (IPL)  
Instrument Flight Instructor—Powered Lift (IPI)  
Instrument Rating—Foreign Pilot (IFP)  
Instrument Flight Instructor—Airplane (FII)  
Instrument Flight Instructor—Rotorcraft/Helicopter - (FIH)  
Instrument Flight Instructor—Airplane (added rating) (AIF)  
Instrument Flight Instructor—Rotorcraft/Helicopter (added rating) (HIF)  
Ground Instructor—Instrument (IGI)

FAA-CT-8080-3F supercedes FAA-CT-8080-3E, Computer Testing Supplement for Instrument Rating, dated 2005.

Comments regarding this supplement, or any AFS-630 publication, should be sent in email form to the following address:

[AFS630comments@faa.gov](mailto:AFS630comments@faa.gov)



# Contents

<b>Preface</b> .....	<b>iii</b>
<b>Contents</b> .....	<b>v</b>
<b>Appendix 1</b> .....	<b>1</b>
<b>Legend 1.—Abbreviations</b> .....	<b>3</b>
<b>Legend 1A.—Abbreviations</b> .....	<b>4</b>
<b>Legend 1B.—Abbreviations</b> .....	<b>5</b>
<b>Legend 1C.—Abbreviations</b> .....	<b>6</b>
<b>Legend 1D.—Abbreviations</b> .....	<b>7</b>
<b>Legend 1E.—Abbreviations</b> .....	<b>8</b>
<b>Legend 1F.—Abbreviations</b> .....	<b>9</b>
<b>Legend 2.—Airport/Facility Directory</b> .....	<b>10</b>
<b>Legend 3.—Airport/Facility Directory</b> .....	<b>11</b>
<b>Legend 4.—Airport/Facility Directory</b> .....	<b>12</b>
<b>Legend 5.—Airport/Facility Directory</b> .....	<b>13</b>
<b>Legend 6.—Airport/Facility Directory</b> .....	<b>14</b>
<b>Legend 7.—Airport/Facility Directory</b> .....	<b>15</b>
<b>Legend 8.—Airport/Facility Directory</b> .....	<b>16</b>
<b>Legend 9.—Airport/Facility Directory</b> .....	<b>17</b>
<b>Legend 10.—Airport/Facility Directory</b> .....	<b>18</b>
<b>Legend 11.—Airport/Facility Directory</b> .....	<b>19</b>
<b>Legend 12.—Airport/Facility Directory</b> .....	<b>20</b>
<b>Legend 13.—Airport/Facility Directory</b> .....	<b>21</b>
<b>Legend 14.—Airport/Facility Directory</b> .....	<b>22</b>
<b>Legend 15.—Airport/Facility Directory</b> .....	<b>23</b>
<b>Legend 16.—Airport/Facility Directory</b> .....	<b>24</b>
<b>Legend 17.—Airport/Facility Directory</b> .....	<b>25</b>
<b>Legend 18.—Airport/Facility Directory</b> .....	<b>26</b>
<b>Legend 19.—Airport/Facility Directory</b> .....	<b>27</b>
<b>Legend 20.—Instrument Approach Procedures Explanation of Terms</b> .....	<b>28</b>
<b>Legend 21.—Instrument Approach Procedures Explanation of Terms</b> .....	<b>29</b>
<b>Legend 22.—General Information</b> .....	<b>30</b>
<b>Legend 23.—Abbreviations</b> .....	<b>31</b>
<b>Legend 23A.—Abbreviations</b> .....	<b>32</b>
<b>Legend 24.—Instrument Approach Procedures (Symbols)</b> .....	<b>33</b>
<b>Legend 25.—Instrument Approach Procedures (Symbols)</b> .....	<b>34</b>
<b>Legend 26.—Instrument Approach Procedures (Profile)</b> .....	<b>35</b>
<b>Legend 27.—Instrument Takeoff or Approach Procedure Charts, Rate-of-Climb/Descent Table</b> .....	<b>36</b>
<b>Legend 28.—Standard Arrival/Departure Charts</b> .....	<b>37</b>
<b>Legend 29.—Airport Diagram</b> .....	<b>38</b>
<b>Legend 30.—Approach Lighting Systems</b> .....	<b>39</b>
<b>Legend 31.—Approach Lighting System</b> .....	<b>40</b>
<b>Legend 32.—Inoperative Components or Visual Aids Table</b> .....	<b>41</b>
<b>Legend 33.—IFR En Route Low Altitude (U.S.)</b> .....	<b>42</b>
<b>Legend 34.—IFR En Route Low Altitude (U.S.)</b> .....	<b>43</b>
<b>Legend 35.—IFR En Route Low Altitude (U.S.)</b> .....	<b>44</b>

<b>Legend 36.—Aircraft Equipment Suffixes .....</b>	<b>45</b>
<b>Legend 37.—Air Navigation Radio Aids.....</b>	<b>46</b>
<b>Legend 38.—ILS Standard Characteristics and Terminology.....</b>	<b>47</b>
<b>Legend 39.—Temperature Conversion Chart.....</b>	<b>48</b>
<b>Appendix 2 .....</b>	<b>49</b>
<b>Figure 2.—Wind and Temperatures Aloft Forecast.....</b>	<b>51</b>
<b>Figure 3.—Standard Conversion Chart.....</b>	<b>52</b>
<b>Figure 4.—Weather Depiction Chart.....</b>	<b>53</b>
<b>Figure 5.—Symbol Used on Low-Level Significant Weather Prognostic Chart.....</b>	<b>54</b>
<b>Figure 7.—High-Level Significant Weather Prognostic Chart.....</b>	<b>55</b>
<b>Figure 13.—Microburst Section Chart.....</b>	<b>56</b>
<b>Figure 18.—U.S. Low-Level Significant Weather Prognostic Charts .....</b>	<b>57</b>
<b>Figure 19.—U.S. Low-Level Significant Weather Prognostic Charts .....</b>	<b>58</b>
<b>Figure 20.—High-Level Significant Weather Prognostic Chart.....</b>	<b>59</b>
<b>Figure 24.—En Route Low-Altitude Chart Segment.....</b>	<b>60</b>
<b>Figure 31.—En Route Low-Altitude Chart Segment.....</b>	<b>61</b>
<b>Figure 34.—En Route Low-Altitude Chart Segment.....</b>	<b>62</b>
<b>Figure 40.—En Route Low-Altitude Chart Segment.....</b>	<b>63</b>
<b>Figure 47.—En Route Low-Altitude Chart Segment.....</b>	<b>64</b>
<b>Figure 48.—CDI—NAV 1 .....</b>	<b>65</b>
<b>Figure 53.—En Route Low-Altitude Chart Segment.....</b>	<b>66</b>
<b>Figure 59.—En Route Low-Altitude Chart Segment.....</b>	<b>67</b>
<b>Figure 61.—CDI Indicator .....</b>	<b>68</b>
<b>Figure 64.—Excerpt from Chart Supplement (LFT).....</b>	<b>69</b>
<b>Figure 65.—En Route Low-Altitude Chart Segment.....</b>	<b>70</b>
<b>Figure 66.—CDI and OBS Indicators.....</b>	<b>71</b>
<b>Figure 67.—Localizer Symbol .....</b>	<b>72</b>
<b>Figure 71.—En Route Low-Altitude Chart Segment.....</b>	<b>73</b>
<b>Figure 71A.—CDI and OBS Indicators.....</b>	<b>74</b>
<b>Figure 76.—VOR Indications and Excerpts from Chart Supplement (HLN) .....</b>	<b>75</b>
<b>Figure 78.—En Route Low-Altitude Chart Segment.....</b>	<b>76</b>
<b>Figure 81.—Dual VOR System, VOT Check.....</b>	<b>77</b>
<b>Figure 82.—Dual VOR System, Accuracy Check.....</b>	<b>78</b>
<b>Figure 86.—CDI and OBS Indicators.....</b>	<b>79</b>
<b>Figure 87.—En Route Low-Altitude Chart Segment.....</b>	<b>80</b>
<b>Figure 88.—CDI and OBS Indicators.....</b>	<b>81</b>
<b>Figure 89.—En Route Low-Altitude Chart Segment.....</b>	<b>82</b>
<b>Figure 90.—CDI/OBS Indicators .....</b>	<b>83</b>
<b>Figure 91.—En Route Low-Altitude Chart Segment.....</b>	<b>84</b>
<b>Figure 94.—Application Examples for Holding Positions .....</b>	<b>85</b>
<b>Figure 95.—No. 1 and No. 2 NAV Presentation.....</b>	<b>86</b>
<b>Figure 96.—Aircraft Position and Direction of Flight.....</b>	<b>87</b>
<b>Figure 97.—HSI Presentation.....</b>	<b>88</b>
<b>Figure 98.—Aircraft Position.....</b>	<b>89</b>
<b>Figure 99.—HSI Presentation.....</b>	<b>90</b>
<b>Figure 106.—Aircraft Location Relative to VOR .....</b>	<b>91</b>
<b>Figure 109.—CDI Direction from VORTAC .....</b>	<b>92</b>
<b>Figure 110.—CDI Direction from VORTAC .....</b>	<b>93</b>
<b>Figure 111.—CDI Direction from VORTAC .....</b>	<b>94</b>
<b>Figure 112.—Holding Entry Procedure .....</b>	<b>95</b>



<b>Figure 113.</b> — <i>Aircraft Course and DME Indicator</i> .....	96
<b>Figure 114.</b> — <i>Aircraft Course and DME Indicator</i> .....	97
<b>Figure 115.</b> — <i>DME Fix with Holding Pattern</i> .....	98
<b>Figure 116.</b> — <i>Holding Entry Procedure</i> .....	99
<b>Figure 131.</b> — <i>VOR/DME RWY 33L</i> .....	100
<b>Figure 134.</b> — <i>2-BAR VASI</i> .....	101
<b>Figure 135.</b> — <i>3-BAR VASI</i> .....	102
<b>Figure 136.</b> — <i>Precision Approach Path Indicator (PAPI)</i> .....	103
<b>Figure 137.</b> — <i>Precision Instrument Runway</i> .....	104
<b>Figure 138.</b> — <i>Runway Legend</i> .....	105
<b>Figure 139.</b> — <i>Glide Slope and Localizer Illustration</i> .....	106
<b>Figure 140.</b> — <i>OBS, ILS, and GS Displacement</i> .....	107
<b>Figure 141.</b> — <i>OBS, ILS, and GS Displacement</i> .....	108
<b>Figure 142.</b> — <i>OBS, ILS, and GS Displacement</i> .....	109
<b>Figure 144.</b> — <i>Turn-and-Slip indicator</i> .....	110
<b>Figure 145.</b> — <i>Instrument Sequence (Unusual Attitude)</i> .....	111
<b>Figure 146.</b> — <i>Instrument Sequence (System Failed)</i> .....	112
<b>Figure 147.</b> — <i>Instrument Sequence (Unusual Attitude)</i> .....	113
<b>Figure 148.</b> — <i>Instrument Interpretation (System Malfunction)</i> .....	114
<b>Figure 149.</b> — <i>Instrument Interpretation (System Malfunction)</i> .....	115
<b>Figure 150.</b> — <i>Instrument Interpretation (Instrument Malfunction)</i> .....	116
<b>Figure 151.</b> — <i>Instrument Interpretation (Instrument Malfunction)</i> .....	117
<b>Figure 155.</b> — <i>Grand Junction Six Departure (JNC6.JNC)</i> .....	118
<b>Figure 156.</b> — <i>Grand Junction Hot Spots</i> .....	119
<b>Figure 157.</b> — <i>ILS RWY 11 (GJT)</i> .....	120
<b>Figure 158.</b> — <i>ILS RWY 11 (GJT)</i> .....	121
<b>Figure 159.</b> — <i>ILS/DME RWY 3 (DRO)</i> .....	122
<b>Figure 160.</b> — <i>ILS or LOC/DME RWY 16L (EUG)</i> .....	123
<b>Figure 161.</b> — <i>ILS or LOC/DME RWY 16R (EUG)</i> .....	124
<b>Figure 162.</b> — <i>Excerpt from Chart Supplement</i> .....	125
<b>Figure 163.</b> — <i>GNATS Six Departure (GNATS6.GNATS)</i> .....	126
<b>Figure 164.</b> — <i>GNATS Six Departure (GNATS6.GNATS)</i> .....	127
<b>Figure 165.</b> — <i>Excerpt from Chart Supplement</i> .....	128
<b>Figure 166.</b> — <i>Chart Supplement (HOT)</i> .....	129
<b>Figure 167.</b> — <i>BONHAM Six Arrival Transition Routes (BYP.BYP6) (DFW)</i> .....	130
<b>Figure 168.</b> — <i>BONHAM Six Arrival Routes (BYP.BYP6) (DFW)</i> .....	131
<b>Figure 169.</b> — <i>Excerpt from Chart Supplement (ADS)</i> .....	132
<b>Figure 170.</b> — <i>ILS or LOC RWY 33 (ADS)</i> .....	133
<b>Figure 171.</b> — <i>RNAV (GPS) RWY 33 (ADS)</i> .....	134
<b>Figure 172.</b> — <i>Excerpt from Chart Supplement</i> .....	135
<b>Figure 172A.</b> — <i>Excerpt from Chart Supplement</i> .....	136
<b>Figure 173.</b> — <i>Excerpt from Chart Supplement</i> .....	137
<b>Figure 174.</b> — <i>GLEN ROSE Nine Arrival (JEN.JEN9)</i> .....	138
<b>Figure 175.</b> — <i>GLEN ROSE Nine Arrival (JEN.JEN9)</i> .....	139
<b>Figure 176.</b> — <i>ILS-1 RWY 36L, Dallas-Fort Worth Intl.</i> .....	140
<b>Figure 176A.</b> — <i>ILS-1 RWY 36L, Dallas-Fort Worth Intl.</i> .....	141
<b>Figure 177.</b> — <i>Converging ILS RWY 36L (DFW)</i> .....	142
<b>Figure 178.</b> — <i>ILS or LOC Y RWY 13L (DAL)</i> .....	143
<b>Figure 179.</b> — <i>ILS or LOC RWY 31 (RBD)</i> .....	144
<b>Figure 180.</b> — <i>ILS or LOC/DME RWY 34 (GKY)</i> .....	145
<b>Figure 181.</b> — <i>Excerpt from Chart Supplement</i> .....	146

<b>Figure 182.</b> — <i>GROMO Three Departure (GROMO3.GROMO)</i> .....	147
<b>Figure 183.</b> — <i>GROMO Three Departure (GROMO3.GROMO)</i> .....	148
<b>Figure 184.</b> — <i>Excerpt from Chart Supplement</i> .....	149
<b>Figure 185.</b> — <i>Airport Diagram - Portland INTL (PDX)</i> .....	150
<b>Figure 186.</b> — <i>ILS or LOC RWY 10R (PDX)</i> .....	151
<b>Figure 187.</b> — <i>RNAV (GPS) X RWY 28L (PDX)</i> .....	152
<b>Figure 188.</b> — <i>LOC/DME RWY 21 (PDX)</i> .....	153
<b>Figure 189.</b> — <i>HABUT Four Departure (HABUT4.GVO) (SBA)</i> .....	154
<b>Figure 190.</b> — <i>Excerpt from Chart Supplement</i> .....	155
<b>Figure 191.</b> — <i>RNAV (GPS) RWY 19 (PRB)</i> .....	156
<b>Figure 192.</b> — <i>VOR/DME-B (PRB)</i> .....	157
<b>Figure 193.</b> — <i>Excerpts from Chart Supplement</i> .....	158
<b>Figure 194.</b> — <i>Excerpts from Chart Supplement</i> .....	159
<b>Figure 195.</b> — <i>Excerpt from Chart Supplement</i> .....	160
<b>Figure 196.</b> — <i>ILS or LOC RWY 4 (HOU)</i> .....	161
<b>Figure 197.</b> — <i>RNAV (GPS) RWY 35L(DWH)</i> .....	162
<b>Figure 198.</b> — <i>Excerpt from Chart Supplement</i> .....	163
<b>Figure 199.</b> — <i>COPTER VOR/DME RWY 12 (HUM)</i> .....	164
<b>Figure 200.</b> — <i>VOR RWY 12 (HUM)</i> .....	165
<b>Figure 201.</b> — <i>Excerpt from Chart Supplement</i> .....	166
<b>Figure 202.</b> — <i>Airport Diagram: New Iberia/Acadiana RGNL (ARA)</i> .....	167
<b>Figure 203.</b> — <i>Excerpt from Chart Supplement</i> .....	168
<b>Figure 203A.</b> — <i>Excerpt from Chart Supplement</i> .....	169
<b>Figure 204.</b> — <i>Airport Diagram: New ORLEANS/LAKEFRONT (NEW)</i> .....	170
<b>Figure 205.</b> — <i>Airport Diagram: Honolulu Intl (HNL) (PHNL)</i> .....	171
<b>Figure 206.</b> — <i>Excerpt from Chart Supplement</i> .....	172
<b>Figure 208.</b> — <i>STELA One Arrival (STELA.STELA1)</i> .....	174
<b>Figure 209.</b> — <i>STELA One Arrival (STELA.STELA1)</i> .....	175
<b>Figure 210.</b> — <i>ILS or LOC RWY 6 (CAT I) (BDL)</i> .....	176
<b>Figure 211.</b> — <i>STAKK Three Departure (STAKK3.STAKK) (HLN)</i> .....	177
<b>Figure 212.</b> — <i>RNAV (GPS) RWY 28R (BIL)</i> .....	178
<b>Figure 213.</b> — <i>VOR/DME RWY 28R (BIL)</i> .....	179
<b>Figure 214.</b> — <i>Excerpt from Chart Supplement</i> .....	180
<b>Figure 215.</b> — <i>GPS RWY 19 (TRK)</i> .....	181
<b>Figure 216.</b> — <i>RENO Nine Departure (RENO9.FMG) (RNO)</i> .....	182
<b>Figure 216A.</b> — <i>RENO Nine Departure (RENO9.FMG) (RNO)</i> .....	183
<b>Figure 217.</b> — <i>ILS or LOC RWY 13 (DSM)</i> .....	184
<b>Figure 218.</b> — <i>RNAV (GPS) RWY 5 (DSM)</i> .....	185
<b>Figure 219.</b> — <i>RNAV (GPS)-A (RIR)</i> .....	186
<b>Figure 220.</b> — <i>Takeoff Minimums and (Obstacle) Departure Procedures</i> .....	187
<b>Figure 221.</b> — <i>ILS or LOC RWY 24R (LAX)</i> .....	188
<b>Figure 222.</b> — <i>ILS or LOC Z RWY 8 (BUR)</i> .....	189
<b>Figure 223.</b> — <i>ILS or LOC RWY 31 (DSM)</i> .....	190
<b>Figure 224.</b> — <i>GPS RWY 16 (LXV)</i> .....	191
<b>Figure 225.</b> — <i>Takeoff Minimums and (Obstacle) Departure Procedures</i> .....	192
<b>Figure 226.</b> — <i>Excerpt from Chart Supplement</i> .....	193
<b>Figure 227.</b> — <i>ILS or LOC RWY 35R (APA)</i> .....	194
<b>Figure 228.</b> — <i>ILS or LOC RWY 31 (FFC)</i> .....	195
<b>Figure 229.</b> — <i>RNAV (GPS) RWY 13 (FFC)</i> .....	196
<b>Figure 230.</b> — <i>VOR/DME or GPS-A (7D3)</i> .....	197
<b>Figure 231.</b> — <i>Excerpt from Chart Supplement</i> .....	198

<b>Figure 232.</b> — <i>LOC RWY 35 (DUC)</i> .....	199
<b>Figure 233.</b> — <i>RNAV (GPS) RWY 17 (DUC)</i> .....	200
<b>Figure 234.</b> — <i>ILS or LOC RWY 18 (LNK)</i> .....	201
<b>Figure 235.</b> — <i>RNAV (GPS) RWY 32 (LNK)</i> .....	202
<b>Figure 236.</b> — <i>ILS or RWY 32 (DHN)</i> .....	203
<b>Figure 237.</b> — <i>RNAV (GPS) RWY 10 (LHQ)</i> .....	204
<b>Figure 238.</b> — <i>RNAV (GPS) RWY 28 (LHQ)</i> .....	205
<b>Figure 239.</b> — <i>LOC RWY 28 (LHQ)</i> .....	206
<b>Figure 240.</b> — <i>VOR/DME RWY 36 (PUC)</i> .....	207
<b>Figure 241.</b> — <i>RNAV (GPS) RWY 36 (PUC)</i> .....	208
<b>Figure 242.</b> — <i>RNAV RWY 36 (LIT)</i> .....	209
<b>Figure 243.</b> — <i>RNAV (GPS) RWY 6 (ROA)</i> .....	210
<b>Figure 244.</b> — <i>LDA RWY 6 (ROA)</i> .....	211
<b>Figure 245.</b> — <i>RNAV (GPS)-B (CQX)</i> .....	212
<b>Figure 247.</b> — <i>ILS or RWY 9 (RAL)</i> .....	213
<b>Figure 248.</b> — <i>RNAV (GPS) RWY 27 (RAL)</i> .....	214
<b>Figure 249.</b> — <i>RNAV (GPS) RWY 30 (LBF)</i> .....	215
<b>Figure 250.</b> — <i>GPS RWY 3 (OWK)</i> .....	216
<b>Figure 251.</b> — <i>Airport Diagram: Osh Kosh/Wittman Regional (OSH)</i> .....	217
<b>Figure 252.</b> — <i>ILS or LOC RWY 36 (OSH)</i> .....	218
<b>Figure 253.</b> — <i>RNAV (GPS) RWY 18 (OSH)</i> .....	219
<b>Figure 254.</b> — <i>Airport Sign</i> .....	220
<b>Figure 255.</b> — <i>Two Signs</i> .....	221
<b>Figure 256.</b> — <i>Airport Diagram and Sign</i> .....	222
<b>Figure 257.</b> — <i>Taxiway Diagram and Sign</i> .....	223
<b>Figure 258.</b> — <i>Instrument Landing System (ILS) Critical Area Markings</i> .....	224
<b>Figure 259.</b> — <i>Airport Signs</i> .....	225
<b>Figure 260.</b> — <i>Graphical Forecast for Aviation</i> .....	226
<b>Figure 261.</b> — <i>Graphical Forecast for Aviation</i> .....	227
<b>Figure 262.</b> — <i>Graphical Forecast for Aviation</i> .....	228
<b>Figure 263.</b> — <i>Graphical Forecast for Aviation</i> .....	229
<b>Figure 264.</b> — <i>Graphical Forecast for Aviation</i> .....	230
<b>Figure 265.</b> — <i>Graphical Forecast for Aviation</i> .....	231
<b>Figure 266.</b> — <i>Graphical Forecast for Aviation</i> .....	232
<b>Figure 267.</b> — <i>Graphical Forecast for Aviation</i> .....	233
<b>Figure 268.</b> — <i>Graphical Forecast for Aviation</i> .....	234
<b>Figure 269.</b> — <i>Graphical Forecast for Aviation</i> .....	235
<b>Figure 270.</b> — <i>Graphical Forecast for Aviation</i> .....	236
<b>Figure 271.</b> — <i>Graphical Forecast for Aviation</i> .....	237



# **APPENDIX 1**



## 4

## GENERAL INFORMATION

## ABBREVIATIONS

The following abbreviations/acronyms are those commonly used within this Directory. Other abbreviations/acronyms may be found in the Legend and are not duplicated below. The abbreviations presented are intended to represent grammatical variations of the basic form. (Example—"req" may mean "request", "requesting", "requested", or "requests").

<b>Abbreviation</b> .....	<b>Description</b>	<b>Abbreviation</b> .....	<b>Description</b>
A/G .....	air/ground	AM .....	Amplitude Modulation, midnight til noon
AAF .....	Army Air Field	AMC .....	Air Mobility Command
AAS .....	Airport Advisory Service	amdt.....	amendment
AB .....	Airbase	AMSL .....	Above Mean Sea Level
abm .....	abeam	ANGS .....	Air National Guard Station
ABn .....	Aerodrome Beacon	ant .....	antenna
abv .....	above	AOE.....	Airport/Aerodrome of Entry
ACC .....	Air Combat Command Area Control Center	AP .....	Area Planning
acft .....	aircraft	APAPI .....	Abbreviated Precision Approach Path Indicator
ACLS.....	Automatic Carrier Landing System	apch.....	approach
act .....	activity	apn.....	apron
ACWS .....	Aircraft Control and Warning Squadron	APP .....	Approach Control
ADA.....	Advisory Area	Apr .....	April
ADCC.....	Air Defense Control Center	aprx.....	approximate
ADCUS.....	Advise Customs	APU .....	Auxiliary Power Unit
addn .....	addition	apv, apvl .....	approve, approval
ADF .....	Automatic Direction Finder	ARB.....	Air Reserve Base
adj.....	adjacent	ARCAL (CANADA) .....	Aircraft Radio Control of Aerodrome Lighting
admin .....	administration	ARFF .....	Aircraft Rescue and Fire Fighting
ADR.....	Advisory Route	ARINC .....	Aeronautical Radio Inc
adv.....	advise	arg.....	arrange
advsy .....	advisory	arpt .....	airport
AEIS.....	Aeronautical Enroute Information Service	arr .....	arrive
AER .....	approach end runway	ARS.....	Air Reserve Station
AFA.....	Army Flight Activity	ARSA .....	Airport Radar Service Area
AFB.....	Air Force Base	ARSR.....	Air Route Surveillance Radar
afct .....	affect	ARTCC.....	Air Route Traffic Control Center
AFFF.....	Aqueous Film Forming Foam	AS .....	Air Station
AFHP .....	Air Force Heliport	ASAP .....	as soon as possible
AFIS.....	Aerodrome Flight Information Service	ASDA.....	Accelerate-Stop Distance Available
afld .....	airfield	ASDE.....	Airport Surface Detection
AFOD .....	Army Flight Operations Detachment	ASDE-X .....	Airport Surface Detection Equipment-Model X
AFR .....	Air Force Regulation	asgn .....	assign
AFRC .....	Armed Forces Reserve Center/Air Force Reserve Command	ASL .....	Above Sea Level
AFRS .....	American Forces Radio Stations	ASOS .....	Automated Surface Observing System
AFS.....	Air Force Station	ASR .....	Airport Surveillance Radar
AFSS.....	Automated Flight Service Station	ASSC .....	Airport Surface Surveillance Capability
AFTN .....	Aeronautical Fixed Telecommunication Network	ASU.....	Aircraft Starting Unit
AG .....	Agriculture	ATA .....	Actual Time of Arrival
A-G, A-GEAR .....	Arresting Gear	ATC .....	Air Traffic Control
agcy .....	Agency	ATCC .....	Air Traffic Control Center
AGL .....	above ground level	ATCT .....	Airport Traffic Control Tower
AHP .....	Army heliport	ATD .....	Actual Time of Departure Along Track Distance
AID .....	Airport Information Desk	ATIS .....	Automatic Terminal Information Service
AIS .....	Aeronautical Information Services	ATS .....	Air Traffic Service
AL .....	Approach and Landing Chart	attn .....	attention
ALF.....	Auxiliary Landing Field	Aug .....	August
ALS.....	Approach Light System	auth.....	authority
ALSF-1 .....	High Intensity ALS Category I configuration with sequenced Flashers (code)	auto.....	automatic
ALSF-2 .....	High Intensity ALS Category II configuration with sequenced Flashers (code)	AUW .....	All Up Weight (gross weight)
alt.....	altitude	aux .....	auxiliary
altn.....	alternate	AVASI .....	abbreviated VASI
		avbl .....	available
		AvGas.....	Aviation gasoline
		avn .....	aviation
		AvOil.....	aviation oil

LEGEND 1.—Abbreviations.

## GENERAL INFORMATION

5

Abbreviation	Description	Abbreviation	Description
AWOS	Automatic Weather Observing System	crdr	corridor
AWSS	Automated Weather Sensor System	cross	cross
awt	await	CRP	Compulsory Reporting Point
awy	airway	crs	course
az	azimuth	CS	call sign
		CSTMS	Customs
BA	braking action	CTA	Control Area
BASH	Bird Aircraft Strike Hazard	CTAF	Common Traffic Advisory Frequency
BC	back course	ctc	contact
bcn	beacon	ctl	control
bcst	broadcast	CTLZ	Control Zone
bdry	boundary	CVFR	Controlled Visual Flight Rules Areas
bldg	building	CW	Clockwise, Continuous Wave, Carrier Wave
blkd	blocked		
blo, blw	below	dalgt	daylight
BOQ	Bachelor Officers Quarters	D-ATIS	Digital Automatic Terminal Information Service
brg	bearing	daylt	daylight
btn	between	db	decibel
bus	business	DCL	Departure Clearance
byd	beyond	Dec	December
		decom	decommission
C	Commercial Circuit (Telephone)	deg	degree
CAC	Centralized Approach Control	del	delivery
cap	capacity	dep	depart
cat	category	DEP	Departure Control
CAT	Clear Air Turbulence	destn	destination
CCW or cntclkws	counterclockwise	det	detachment
ceil	ceiling	DF	Direction Finder
CERAP	Center Radar Approach Control	DH	Decision Height
CG	Coast Guard	DIAP	DoD Instrument Approach Procedure
CGAF	Coast Guard Air Facility	direc	directional
CGAS	Coast Guard Air Station	disem	disseminate
CH, chan	channel	displ	displace
CHAPI	Chase Helicopter Approach Path Indicator	dist	district, distance
chg	change	div	division
cht	chart	DL	Direct Line to FSS
cir	circle, circling	dlt	delete
CIV, civ	Civil, civil, civilian	dly	daily
ck	check	DME	Distance Measuring Equipment (UHF standard, TACAN compatible)
CL	Centerline Lighting System	DNVT	Digital Non-Secure Voice Telephone
cl	class	DoD	Department of Defense
clnc	clearance	drct	direct
clsd	closed	DSN	Defense Switching Network (Telephone)
CNATRA	Chief of Naval Air Training	DSN	Defense Switching Network
cnl	cancel	dsplcd	displaced
cntr	center	DT	Daylight Savings Time
cntrln	centerline	dur	during
Co	Company, County	durn	duration
CO	Commanding Officer	DV	Distinguished Visitor
com	communication		
cmd	command	E	East
Comdr	Commander	ea	each
coml	commercial	EAT	Expected Approach Time
compul	compulsory	ECN	Enroute Change Notice
comsn	commission	EFAS	Enroute Flight Advisory Service
conc	concrete	eff	effective, effect
cond	condition	E-HA	Enroute High Altitude
const	construction	E-LA	Enroute Low Altitude
cont	continue	elev	elevation
CONUS	Continental United States	ELT	Emergency Locator Transmitter
convl	conventional		
coord	coordinate	EMAS	Engineered Material Arresting System
copter	helicopter	emerg	emergency
corr	correct	eng	engine
CPDLC	Controller Pilot Data Link Communication		

LEGEND 1A.—Abbreviations.



## 6

## GENERAL INFORMATION

<b>Abbreviation</b> .....	<b>Description</b>	<b>Abbreviation</b> .....	<b>Description</b>
EOR .....	End of Runway	govt .....	government
eqpt .....	equipment	GP .....	Glide Path
ERDA .....	Energy Research and Development Administration	Gp .....	Group
E-S .....	Enroute Supplement	GPI .....	Ground Point of Intercept
est .....	estimate	grad .....	gradient
estab .....	establish	grd .....	guard
ETA .....	Estimated Time of Arrival	GS .....	glide slope
ETD .....	Estimated Time of Departure	GWT .....	gross weight
ETE .....	Estimated Time Enroute	H .....	Enroute High Altitude Chart (followed by identification)
ETS .....	European Telephone System	H+ .....	Hours or hours plus...minutes past the hour
EUR .....	European (ICAO Region)	H24 .....	continuous operation
ev .....	every	HAA .....	Height Above Airport/Aerodrome
evac .....	evacuate	HAL .....	Height Above Landing Area
exc .....	except	HAR .....	Height Above Runway
exclد .....	exclude	HAT .....	Height Above Touchdown
exer .....	exercise	haz .....	hazard
exm .....	exempt	hdg .....	heading
exp .....	expect	HDTA .....	High Density Traffic Airport/Aerodrome
extد .....	extend	HF .....	High Frequency (3000 to 30,000 KHz)
extn .....	extension	hgr .....	hangar
extv .....	extensive	hgt .....	height
F/W .....	Fixed Wing	hi .....	high
FAA .....	Federal Aviation Administration	HIRL .....	High Intensity Runway Lights
fac .....	facility	HIWAS .....	Hazardous Inflight Weather Advisory Service
FAWS .....	Flight Advisory Weather Service	HO .....	Service available to meet operational requirements
fax .....	facsimile	hol .....	holiday
FBO .....	Fixed Base Operator	HOLF .....	Helicopter Outlying Field
FCC .....	Flight Control Center	hosp .....	hospital
FCG .....	Foreign Clearance Guide	HQ .....	Headquarters
FCLP .....	field carrier landing practice	hr .....	hour
fcst .....	forecast	HS .....	Service available during hours of scheduled operations
Feb .....	February	hsg .....	housing
FIC .....	Flight Information Center	hvy .....	heavy
FIH .....	Flight Information Handbook	HW .....	Heavy Weight
FIR .....	Flight Information Region	hwy .....	highway
FIS .....	Flight Information Service	HX .....	station having no specific working hours
FL .....	flight level	Hz .....	Hertz (cycles per second)
fld .....	field	I .....	Island
flg .....	flashing	IAP .....	Instrument Approach Procedure
FLIP .....	Flight Information Publication	IAS .....	Indicated Air Speed
flt .....	flight	IAW .....	in accordance with
flw .....	follow	ICAO .....	International Civil Aviation Organization
FM .....	Fan Marker, Frequency Modulation	ident .....	identification
FOC .....	Flight Operations Center	IFF .....	Identification, Friend or Foe
FOD .....	Foreign Object Damage	IFR .....	Instrument Flight Rules
fone .....	telephone	IFR-S .....	FLIP IFR Supplement
FPL .....	Flight Plan	IFSS .....	International Flight Service Station
fpm .....	feet per minute	ILS .....	Instrument Landing System
fr .....	from	IM .....	Inner Marker
freq .....	frequency, frequent	IMC .....	Instrument Meteorological Conditions
Fri .....	Friday	IMG .....	Immigration
frng .....	firing	immed .....	immediate
FSC .....	Flight Service Center	inbd .....	inbound
FSS .....	Flight Service Station	Inc .....	Incorporated
ft .....	foot	incl .....	include
ftr .....	fighter	incr .....	increase
GA .....	Glide Angle	indef .....	indefinite
gal .....	gallon	info .....	information
GAT .....	General Air Traffic (Europe-Asia)	inop .....	inoperative
GCA .....	Ground Control Approach	inst .....	instrument
GCO .....	Ground Communication Outlet		
glدر .....	glider		
GND .....	Ground Control		
gnd .....	ground		

LEGEND 1B.—Abbreviations.

## GENERAL INFORMATION

7

<b>Abbreviation</b> .....	<b>Description</b>	<b>Abbreviation</b> .....	<b>Description</b>
instl .....	install	LSB .....	lower side band
instr .....	instruction	ltd .....	limited
int .....	intersection		
intcntl .....	intercontinental	M .....	meters, magnetic (after a bearing), Military Circuit (Telephone)
intcp .....	intercept	MACC .....	Military Area Control Center
intl .....	international	mag .....	magnetic
intmt .....	intermittent	maint .....	maintain, maintenance
ints .....	intense, intensity	maj .....	major
invof .....	in the vicinity of	MALS .....	Medium Intensity Approach Lighting System
irreg .....	Irregularly	MALSF .....	MALS with Sequenced Flashers
		MALSR .....	MALS with Runway Alignment Indicator Lights
Jan .....	January	Mar .....	March
JASU .....	Jet Aircraft Starting Unit	MARA .....	Military Activity Restricted Area
JATO .....	Jet Assisted Take-Off	MATO .....	Military Air Traffic Operations
JOAP .....	Joint Oil Analysis Program	MATZ .....	Military Aerodrome Traffic Zone
JOSAC .....	Joint Operational Support Airlift Center	max .....	maximum
JRB .....	Joint Reserve Base	mb .....	millibars
Jul .....	July	MCAC .....	Military Common Area Control
Jun .....	June	MCAF .....	Marine Corps Air Facility
		MCALF .....	Marine Corps Auxiliary Landing Field
K or Kt .....	Knots	MCAS .....	Marine Corps Air Station
kHz .....	kilohertz	MCB .....	Marine Corps Base
KIAS .....	Knots Indicated Airspeed	MCC .....	Military Climb Corridor
KLIZ .....	Korea Limited Identification Zone	MCOLF .....	Marine Corps Outlying Field
km .....	Kilometer	MDA .....	Minimum Descent Altitude
kw .....	kilowatt	MEA .....	Minimum Enroute Altitude
		med .....	medium
L .....	Compass locator (Component of ILS system) under 25 Watts, 15 NM, Enroute Low Altitude Chart (followed by identification)	MEHT .....	Minimum Eye Height over Threshold
L .....	Local Time	mem .....	memorial
LAA .....	Local Airport Advisory	MET .....	Meteorological, Meteorology
LAHSO .....	Land and Hold-Short Operations	METAR .....	Aviation Routine Weather Report (in international MET figure code)
L-AOE .....	Limited Airport of Entry	METRO .....	Pilot-to-Metro voice cell
LAWRS .....	Limited Aviation Weather Reporting Station	MF .....	Medium Frequency (300 to 3000 KHz), Mandatory Frequency (Canada)
lb, lbs .....	pound (weight)	MFA .....	Minimum Flight Altitude
LC .....	local call	mgmt .....	Management
lcl .....	local	mgr .....	manager
LCP .....	French Peripheral Classification Line	MHz .....	Megahertz
lctd .....	located	mi .....	mile
lctn .....	location	MID/ASIA .....	Middle East/Asia (ICAO Region)
lctr .....	locator	MJI .....	Meaconing, Intrusion, Jamming, and Interference
LCVASI .....	Low Cost Visual Approach Slope Indicator	Mil, mil .....	military
lczr .....	localizer	min .....	minimum, minute
LD .....	long distance	MIRL .....	Medium Intensity Runway Lights
LDA .....	Landing Distance Available	misl .....	missile
ldg .....	landing	mkr .....	marker (beacon)
LDIN .....	Lead-in Lights	MM .....	Middle Marker of ILS
LDOCF .....	Long Distance Operations Control Facility	mnt .....	monitor
len .....	length	MOA .....	Military Operations Area
lgt, lgtd, lgts .....	light, lighted, lights	MOCA .....	Minimum Obstruction Clearance Altitude
LIRL .....	Low Intensity Runway Lights	mod .....	modify
LLWAS .....	Low-Level Wind Shear Alert System	MOG .....	Maximum (aircraft) on the Ground
LLZ .....	Localizer (Instrument Approach Procedures Identification only)	Mon .....	Monday
LMM .....	Compass locator at Middle Marker ILS	MP .....	Maintenance Period
lo .....	low	MR .....	Medium Range
LoALT or LA .....	Low Altitude	MRA .....	Minimum Reception Altitude
LOC .....	Localizer	mrk .....	mark, marker
LOM .....	Compass locator at Outer Marker ILS	MSAW .....	minimum safe altitude warning
LR .....	Long Range, Lead Radial	msg .....	message
LRA .....	Landing Rights Airport	MSL .....	Mean Sea Level
LRRS .....	Long Range RADAR Station	msn .....	Mission

LEGEND 1C.—Abbreviations.

## 8

## GENERAL INFORMATION

<b>Abbreviation</b> .....	<b>Description</b>	<b>Abbreviation</b> .....	<b>Description</b>
mt .....	mount, mountain	ODALS.....	Omnidirectional Approach Lighting System
MTAF .....	Mandatory Traffic Advisory Frequency	ODO .....	Operations Duty Officer
MTCA.....	Military Terminal Control Area	offl .....	official
mthly .....	monthly	OIC.....	Officer In Charge
MUAC .....	Military Upper Area Control	OLF .....	Outlying Field
muni .....	municipal	OLS .....	Optical Landing System
MWARA .....	Major World Air Route Area	OM.....	Outer Marker, ILS
N.....	North	opr .....	operate, operator, operational
N/A.....	not applicable	OPS, ops.....	operations
NA.....	not authorized (For Instrument Approach Procedure take-off and alternate MINIMA only)	orig.....	original
NAAS.....	Naval Auxiliary Air Station	OROCA .....	Off Route Obstruction Clearance Altitude
NADC.....	Naval Air Development Center	ORTCA.....	Off Route Terrain Clearance Altitude
NADEP.....	Naval Air Depot	OT.....	other times
NAEC .....	Naval Air Engineering Center	OTS.....	out of service
NAES .....	Naval Air Engineering Station	outbd.....	outbound
NAF .....	Naval Air Facility	ovft.....	overflight
NALCO .....	Naval Air Logistics Control Office	ovrn.....	overrun
NALF .....	Naval Auxiliary Landing Field	OX.....	oxygen
NALO .....	Navy Air Logistics Office	P/L.....	plain language
NAS .....	Naval Air Station	PAC.....	Pacific (ICAO Region)
NAT .....	North Atlantic (ICAO Region)	PAEW .....	personnel and equipment working
natl.....	national	PALS .....	Precision Approach and Landing System (NAVY)
nav .....	navigation	PAPI .....	Precision Approach Path Indicator
navaid.....	navigation aid	PAR.....	Precision Approach Radar
NAVMTO .....	Navy Material Transportation Office	para.....	paragraph
NAWC.....	Naval Air Warfare Center	parl .....	parallel
NAWS .....	Naval Air Weapons Station	pat .....	pattern
NCRP .....	Non-Compulsory Reporting Point	PAX .....	Passenger
NDB .....	Non-Directional Radio Beacon	PCL .....	pilot controlled lighting
NE.....	Northeast	pent.....	penetrate
nec .....	necessary	perm.....	permanent
NEW .....	Net Explosives Weight	perms .....	permission
ngt.....	night	pers .....	personnel
NM.....	nautical miles	PFC .....	Porous Friction Courses
nml.....	normal	PJE .....	Parachuting Activities/Exercises
NMR .....	nautical mile radius	p-line .....	power line
No or Nr.....	number	PM.....	Post meridian, noon til midnight
NOLF.....	Naval Outlying Field	PMRF .....	Pacific Missile Range Facility
NORDO .....	Lost communications or no radio installed/available in aircraft	PMSV .....	Pilot-to-Metro Service
NOTAM .....	Notice to Airmen	PN .....	prior notice
Nov.....	November	POB .....	persons on board
npi.....	non precision instrument	POL .....	Petrol, Oils and Lubricants
Nr or No.....	number	posn .....	position
NS .....	Naval Station	PPR.....	prior permission required
NS ABTMT .....	Noise Abatement	prcht.....	parachute
NSA .....	Naval Support Activity	pref .....	prefer
NSF .....	Naval Support Facility	prev .....	previous
NSTD, nstd.....	nonstandard	prim .....	primary
ntc.....	notice	prk .....	park
NVD.....	Night Vision Devices	PRM.....	Precision Runway Monitor
NVG.....	Night Vision Goggles	pro .....	procedure
NW.....	Northwest	proh .....	prohibited
NWC.....	Naval Weapons Center	pt.....	point
O/A.....	On or about	PTD.....	Pilot to Dispatcher
O/S.....	out of service	pub .....	publication
O/R.....	On Request	publ.....	publish
OAT .....	Operational Air Traffic	PVASI .....	Pulsating Visual Approach Slope Indicator
obsn.....	observation	pvt .....	private
obst.....	obstruction	pwr.....	power
OCA.....	Oceanic Control Area	QFE.....	Altimeter Setting above station
ocnl.....	occasional		
Oct .....	October		

LEGEND 1D.—Abbreviations.

## GENERAL INFORMATION

9

Abbreviation	Description	Abbreviation	Description
QNE	Altimeter Setting of 29.92 inches which provides height above standard datum plane	SAR	Search and Rescue
QNH	Altimeter Setting which provides height above mean sea level	Sat	Saturday
qtrs	quarters	SAVASI	Simplified Abbreviated Visual Approach Slope Indicator
quad	quadrant	SAWRS	Supplement Aviation Weather Reporting Station
R/T	Radiotelephony	sby	standby
R/W	Rotary/Wing	Sched	scheduled services
RACON	Radar Beacon	sctr	sector
rad	radius, radial	SDF	Simplified Directional Facility
RAIL	Runway Alignment Indicator Lights	SE	Southeast
RAMCC	Regional Air Movement Control Center	sec	second, section
R-AOE	Regular Airport of Entry	secd	secondary
RAPCON	Radar Approach Control (USAF)	SELCAL	Selective Calling System
RATCF	Radar Air Traffic Control Facility (Navy)	SELF	Strategic Expeditionary Landing Field
RCAG	Remote Center Air to Ground Facility	SEng	Single Engine
RCAGL	Remote Center Air to Ground Facility Long Range	Sep	September
RCL	runway centerline	SFA	Single Frequency Approach
RCLS	Runway Centerline Light System	sfc	surface
RCO	Remote Communications Outlet	SFL	Sequence Flashing Lights
rcpt	reception	SFRA	Special Flight Rules Area
RCR	Runway Condition Reading	SID	Standard Instrument Departure
rcv	receive	SIDA	Secure Identification Display Area
rcvr	receiver	SIF	Selective Identification Feature
rdo	radio	sked	schedule
reconst	reconstruct	SM	statute miles
reful	refueling	SOAP	Spectrometric Oil Analysis Program
reg	regulation, regular	SOF	Supervisor of Flying
REIL	Runway End Identifier Lights	SPB	Seaplane Base
rel	reliable	SR	sunrise
relctd	relocated	SRE	Surveillance Radar Element of GCA (Instrument Approach Procedures Identification only)
REP	Reporting Point	SS	sunset
req	request	SSALS/R	Simplified Short Approach Lighting System/with RAIL
RETIL	Rapid Exit Taxiway Indicator Light	SSB	Single Sideband
Rgn	Region	SSR	Secondary Surveillance Radar
Rgnl	Regional	STA	Straight-in Approach
rgt	right	std	standard
rgt tfc	right traffic	stn	station
rlgd	realigned	stor	storage
RLLS	Runway Lead-in Light System	str-in	Straight-in
rmk	remark	stu	student
rng	range, radio range	subj	subject
RNP	Required Navigation Performance	sum	summer
RON	Remain Overnight	Sun	Sunday
Rot Lt or Bcn	Rotating Light or Beacon	sur	surround
RPI	Runway Point of Intercept	survl	survival, surveillance
rpt	report	suspd	suspended
rqr	require	svc	service
RR	Railroad	svcg	servicing
RRP	Runway Reference Point	SW	Southwest
RSC	Runway Surface Condition	sys	system
RSDU	Radar Storm Detection Unit	TA	Transition Altitude
RSE	Runway Starter Extension/Starter Strip	TAC	Tactical Air Command
RSRS	Reduced Same Runway Separation	TAF	Aerodrome (terminal or alternate) forecast in abbreviated form
rstd	restricted	TALCE	Tanker Aircraft Control Element
rte	route	TCA	Terminal Control Area
ruf	rough	TCH	Threshold Crossing Height
RVR	Runway Visual Range	TCTA	Transcontinental Control Area
RVSM	Reduced Vertical Separation Minima	TD	Touchdown
rwy	runway	TDWR	Terminal Doppler Weather Radar
S	South	TDZ	Touchdown Zone
S/D	Seadrome	TDZL	Touchdown Zone Lights
SALS	Short Approach Lighting System		

LEGEND 1E.—Abbreviations.

## 10

## GENERAL INFORMATION

Abbreviation	Description	Abbreviation	Description
tfc	traffic	vcnty	vicinity
thld	threshold	VDF	Very High Frequency Direction Finder
thou	thousand	veh	vehicle
thru	through	vert	vertical
Thu	Thursday	VFR	Visual Flight Rules
til	until	VFR-S	FLIP VFR Supplement
tkf, tkof	take-off	VHF	Very High Frequency (30 to 300 MHz)
TLv	Transition Level	VIP	Very Important Person
tmpry	temporary	vis	visibility
TODA	Take-Off Distance Available	VMC	Visual Meteorological Conditions
TORA	Take-Off Run Available	VOIP	Voice Over Internet Protocol
TP	Tire Pressure	VOLMET	Meteorological Information for Aircraft in Flight
TPA	Traffic Pattern Altitude	VOT	VOR Receiver Testing Facility
TRACON	Terminal Radar Approach Control (FAA)	W	Warning Area (followed by identification), Watts, West, White
tran	transient	WCH	Wheel Crossing Height
trans	transmit	Wed	Wednesday
trml	terminal	Wg	Wing
trng	training	WIE	with immediate effect
trns	transition	win	winter
TRSA	Terminal Radar Service Area	WIP	work in progress
Tue	Tuesday	WSO	Weather Service Office
TV	Television	WSFO	Weather Service Forecast Office
TWEB	Transcribed Weather Broadcast	wk	week
twr	tower	wkd	weekday
twy	taxiway	wkly	weekly
UACC	Upper Area Control Center (used outside US)	wng	warning
UAS	Unmanned Aerial Systems	wo	without
UC	Under Construction	WSP	Weather System Processor
UCN	Urgent Change Notice	wt	weight
UDA	Upper Advisory Area	wx	weather
UDF	Ultra High Frequency Direction Finder	yd	yard
UFN	until further notice	yr	year
UHF	Ultra High Frequency (300 to 3000 MHz)	Z	Greenwich Mean Time (time groups only)
UIR	Upper Flight Information Region		
unauthd	unauthorized		
unavl	unavailable		
unctl	uncontrolled		
unk	unknown		
unlgt	unlighted		
unltd	unlimited		
unmrk	unmarked		
unmto	unmonitored		
unrel	unreliable		
unrstd	unrestricted		
unsatfy	unsatisfactory		
unsked	unscheduled		
unsvc	unserviceable		
unuse, unusbl	unusable		
USA	United States Army		
USAF	United States Air Force		
USB	Upper Side Band		
USCG	United States Coast Guard		
USMC	United States Marine Corps		
USN	United States Navy		
UTA	Upper Control Area		
UTC	Coordinated Universal Time		
V	Defense Switching Network (telephone, formerly AUTOVON)		
VSTOL	Vertical and Short Take-off and Landing aircraft		
VAL	Visiting Aircraft Line		
var	variation (magnetic variation)		
VASI	Visual Approach Slope Indicator		

LEGEND 1F.—Abbreviations.

12

**AIRPORT/FACILITY DIRECTORY LEGEND**

**SAMPLE**

①  
**CITY NAME**  
 ②  
**AIRPORT NAME** (ALTERNATE NAME) (LTS)(KLTS) CIV/MIL 3 N UTC-6(-5DT) N34°41.93' W99°20.20'  
 200 B TPA-1000(800) AOE LRA Class IV, ARFF Index A NOTAM FILE ORL Not insp.  
 ③  
 ④  
 ⑤  
 ⑥  
 ⑦  
 ⑧  
**JACKSONVILLE COPTER**  
 H-4G, L-19C  
 IAP, DIAP, AD  
 ⑨

⑩  
**RWY 18-36:**H12004X200 (ASPH-CONC-GRVD)  
 S-90, D-160, 2D-300 PCN 80 R/B/W/T HIRL CL  
**RWY 18:** RLLS. MALSF. TDZL. REIL. PAPI(P2R)-GA 3.0° TCH 36'.  
 RVR-TMR. Thld dsplcd 300'. Trees. Rgt tfc. 0.3% up.  
**RWY 36:** ALSF1. 0.4% down.  
**RWY 09-27:** H6000X150 (ASPH) MIRL  
**RWY 173-353:** H3515X150 (ASPH-PFC) AUW PCN 59 F/A/W/T

⑪  
**LAND AND HOLD-SHORT OPERATIONS**

LDG RWY	HOLD-SHORT POINT	AVBL LDG DIST
RWY 18	09-27	6500
RWY 36	09-27	5400

⑫  
**RUNWAY DECLARED DISTANCE INFORMATION**

**RWY 18:** TORA-12004 TODA-12004 ASDA-11704 LDA-11504  
**RWY 36:** TORA-12004 TODA-12004 ASDA-12004 LDA-11704

⑬  
**ARRESTING GEAR/SYSTEM**

**RWY 18** HOOK E5 (65' OVRN) BAK-14 BAK-12B (1650')  
 BAK-14 BAK-12B (1087') HOOK E5 (74' OVRN) **RWY 36**

⑭  
**SERVICE:** S4 FUEL 100LL, JET A OX 1, 3 LGT ACTIVATE MALSR Rwy 29, REIL Rwy 11, VASI Rwy 11, HIRL Rwy 11-29, PAPI Rwy 17 and Rwy 35, MIRL Rwy 17-35-CTAF. **MILITARY—A-GEAR** E-5 connected on dep end, disconnected on apch end.

**JASU** 3(AM32A-60) 2(A/M32A-86) FUEL J8(Mil)(NC-100, A)  
**FLUID** W SP PRESAIR LOX OIL O-128 MAINT S1 Mon-Fri 1000-2200Z‡  
**TRAN ALERT** Avbl 1300-0200Z‡ svc limited weekends.

⑮  
**AIRPORT REMARKS:** Special Air Traffic Rules—Part 93, see Regulatory Notices. Attended 1200-0300Z‡. Parachute Jumping. Deer invof arpt. Heavy jumbo jet training surface to 9000'. Twy A clsd indef. Flight Notification Service (ADCUS) avbl.

⑯  
**MILITARY REMARKS:** ANG PPR/Official Business Only. Base OPS DSN 638-4390, C503-335-4222. Ctc Base OPS 15 minutes prior to ldg and after dep. Limited tran parking.

⑰  
**AIRPORT MANAGER:** (580) 481-5739

⑱  
**WEATHER DATA SOURCES:** AWOS-1 120.3 (202) 426-8000. LAWRS.

⑲  
**COMMUNICATIONS:** SFA CTAF 122.8 UNICOM 122.95 ATIS 127.25 273.5 (202) 426-8003 PTD 372.2

NAME FSS (ORL) on arpt. 123.65 122.65 122.2  
 NAME RCO 112.2T 112.1R (NAME RADIO)

Ⓡ NAME APP/DEP CON 128.35 257.725 (1200-0400Z‡)

TOWER 119.65 255.6 (1200-0400Z‡) GND CON 121.7 GCO 135.075 (ORLANDO CLNC) CLNC DEL 125.55  
 CPDLC D-HZWXR, D-TAXI, DCL (LOGON KMEM)

NAME COMD POST (GERONIMO) 311.0 321.4 6761 PMSV METRO 239.8 NAME OPS 257.5

⑳  
**AIRSPACE:** CLASS B See VFR Terminal Area Chart.

㉑  
**VOR TEST FACILITY (VOT):** 116.7

㉒  
**RADIO AIDS TO NAVIGATION:** NOTAM FILE ORL. VHF/DF ctc FSS.

(H) VORTAC 112.2 MCO Chan 59 N28°32.55' W81°20.12' at fld. 1110/8E.

(H) TACAN Chan 29 CBU (109.2) N28°32.65' W81°21.12' at fld. 1115/8E.

HERNY NDB (LOM) 221 OR N28°37.40' W81°21.05' 177° 5.4 NM to fld.

ILS/DME 108.5 I-ORL Chan 22 Rwy 18. Class IIE. LOM HERNY NDB.

ASR/PAR (1200-0400Z‡)

㉓  
**COMM/NAV/WEATHER REMARKS:** Emerg frequency 121.5 not avbl at twr.

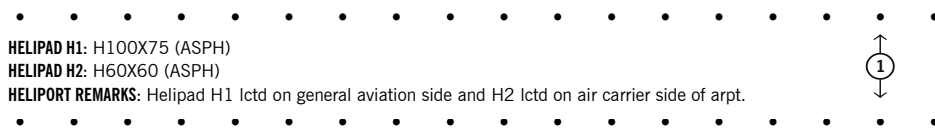

HELIPAD H1: H100X75 (ASPH)

HELIPAD H2: H60X60 (ASPH)

HELIPORT REMARKS: Helipad H1 lctd on general aviation side and H2 lctd on air carrier side of arpt.

187 TPA 1000(813)

WATERWAY 15-33: 5000X425 (WATER)

SEAPLANE REMARKS: Birds roosting and feeding areas along river banks. Seaplanes operating adjacent to SW side of arpt not visible from twr and are required to ctc twr.

All bearings and radials are magnetic unless otherwise specified. All mileages are nautical unless otherwise noted. All times are Coordinated Universal Time (UTC) except as noted. All elevations are in feet above/below Mean Sea Level (MSL) unless otherwise noted. The horizontal reference datum of this publication is North American Datum of 1983 (NAD83), which for charting purposes is considered equivalent to World Geodetic System 1984 (WGS 84).

**AIRPORT/FACILITY DIRECTORY LEGEND**

10

**SKETCH LEGEND**

**RUNWAYS/LANDING AREAS**

- Hard Surfaced . . . . .
- Metal Surface . . . . .
- Sod, Gravel, etc. . . . .
- Light Plane, . . . . .
  - Ski Landing Area or Water
- Under Construction . . . . .
- Closed . . . . .
- Helicopter Landings Area . . . . .
- Displaced Threshold . . . . .
- Taxiway, Apron and Stopways . . . . .

**RADIO AIDS TO NAVIGATION**

- VORTAC . . . . .
- VOR . . . . .
- VOR/DME . . . . .
- NDB . . . . .
- TACAN . . . . .
- NDB/DME . . . . .
- DME . . . . .

**MISCELLANEOUS AERONAUTICAL FEATURES**

- Airport Beacon . . . . .
  - Wind Cone . . . . .
  - Landing Tee . . . . .
  - Tetrahedron . . . . .
  - Control Tower . . . . . or TWR
- When control tower and rotating beacon are co-located beacon symbol will be used and further identified as TWR.

**MISCELLANEOUS BASE AND CULTURAL FEATURES**

- Buildings . . . . .
- Power Lines . . . . .
- Fence . . . . .
- Towers . . . . .
- Wind Turbine . . . . .
- Tanks . . . . .
- Oil Well . . . . .
- Smoke Stack . . . . .
- Obstruction . . . . .
  - Controlling Obstruction . . . . .
- Trees . . . . .
- Populated Places . . . . .
- Cuts and Fills . . . . .
  - Cliffs and Depressions . . . . .
  - Ditch . . . . .
  - Hill . . . . .

**APPROACH LIGHTING SYSTEMS**

- A dot "•" portrayed with approach lighting letter identifier indicates sequenced flashing lights (F) installed with the approach lighting system e.g. Negative symbology, e.g.,
- indicates Pilot Controlled Lighting (PCL).
- Runway Centerline Lighting . . . . .
  - Approach Lighting System ALSF-2 . . . . .
  - Approach Lighting System ALSF-1 . . . . .
  - Short Approach Lighting System SALS/SALSF . . . . .
  - Simplified Short Approach Lighting System (SSALR) with RAIL . . . . .
  - Medium Intensity Approach Lighting System (MALS and MALSF)/(SSALS and SSALF) . . . . .
  - Medium Intensity Approach Lighting System (MALSR) and RAIL . . . . .
  - Omnidirectional Approach Lighting System (ODALS) . . . . .
  - Navy Parallel Row and Cross Bar . . . . .
  - Air Force Overrun . . . . .
  - Visual Approach Slope Indicator with Standard Threshold Clearance provided
  - Pulsating Visual Approach Slope Indicator (PVASI)
  - Visual Approach Slope Indicator with a threshold crossing height to accommodate long bodied or jumbo aircraft
  - Tri-color Visual Approach Slope Indicator (TRCV)
  - Approach Path Alignment Panel (APAP)
  - Precision Approach Path Indicator (PAPI)

LEGEND 3.—Airport/Facility Directory.

**AIRPORT/FACILITY DIRECTORY LEGEND**

**LEGEND**

This directory is a listing of data on record with the FAA on public-use airports, military airports and selected private-use airports specifically requested by the Department of Defense (DoD) for which a DoD Instrument Approach Procedure has been published in the U.S. Terminal Procedures Publication. Additionally this listing contains data for associated terminal control facilities, air route traffic control centers, and radio aids to navigation within the conterminous United States, Puerto Rico and the Virgin Islands. Civil airports and joint Civil/Military airports which are open to the public are listed alphabetically by state, associated city and airport name and cross-referenced by airport name. Military airports and private-use (limited civil access) joint Military/Civil airports are listed alphabetically by state and official airport name and cross-referenced by associated city name. Nav aids, flight service stations and remote communication outlets that are associated with an airport, but with a different name, are listed alphabetically under their own name, as well as under the airport with which they are associated.

The listing of an airport as open to the public in this directory merely indicates the airport operator's willingness to accommodate transient aircraft, and does not represent that the airport conforms with any Federal or local standards, or that it has been approved for use on the part of the general public. Military airports, private-use airports, and private-use (limited civil access) joint Military/Civil airports are open to civil pilots only in an emergency or with prior permission. See Special Notice Section, Civil Use of Military Fields.

The information on obstructions is taken from reports submitted to the FAA. Obstruction data has not been verified in all cases. Pilots are cautioned that objects not indicated in this tabulation (or on the airports sketches and/or charts) may exist which can create a hazard to flight operation. Detailed specifics concerning services and facilities tabulated within this directory are contained in the Aeronautical Information Manual, Basic Flight Information and ATC Procedures.

The legend items that follow explain in detail the contents of this Directory and are keyed to the circled numbers on the sample on the preceding pages.

**① CITY/AIRPORT NAME**

Civil and joint Civil/Military airports which are open to the public are listed alphabetically by state and associated city. Where the city name is different from the airport name the city name will appear on the line above the airport name. Airports with the same associated city name will be listed alphabetically by airport name and will be separated by a dashed rule line. A solid rule line will separate all others. FAA approved helipads and seaplane landing areas associated with a land airport will be separated by a dotted line. Military airports and private-use (limited civil access) joint Military/Civil airports are listed alphabetically by state and official airport name.

**② ALTERNATE NAME**

Alternate names, if any, will be shown in parentheses.

**③ LOCATION IDENTIFIER**

The location identifier is a three or four character FAA code followed by a four-character ICAO code, when assigned, to airports. If two different military codes are assigned, both codes will be shown with the primary operating agency's code listed first. These identifiers are used by ATC in lieu of the airport name in flight plans, flight strips and other written records and computer operations. Zeros will appear with a slash to differentiate them from the letter "O".

**④ OPERATING AGENCY**

Airports within this directory are classified into two categories, Military/Federal Government and Civil airports open to the general public, plus selected private-use airports. The operating agency is shown for military, private-use and joint use airports. The operating agency is shown by an abbreviation as listed below. When an organization is a tenant, the abbreviation is enclosed in parenthesis. No classification indicates the airport is open to the general public with no military tenant.

A	US Army	MC	Marine Corps
AFRC	Air Force Reserve Command	MIL/CIV	Joint Use Military/Civil Limited Civil Access
AF	US Air Force	N	Navy
ANG	Air National Guard	NAF	Naval Air Facility
AR	US Army Reserve	NAS	Naval Air Station
ARNG	US Army National Guard	NASA	National Air and Space Administration
CG	US Coast Guard	P	US Civil Airport Wherein Permit Covers Use by Transient Military Aircraft
CIV/MIL	Joint Use Civil/Military Open to the Public	PVT	Private Use Only (Closed to the Public)
DND	Department of National Defense Canada		

**⑤ AIRPORT LOCATION**

Airport location is expressed as distance and direction from the center of the associated city in nautical miles and cardinal points, e.g., 4 NE.

**⑥ TIME CONVERSION**

Hours of operation of all facilities are expressed in Coordinated Universal Time (UTC) and shown as "Z" time. The directory indicates the number of hours to be subtracted from UTC to obtain local standard time and local daylight saving time UTC-5(-4DT). The symbol ‡ indicates that during periods of Daylight Saving Time (DST) effective hours will be one hour earlier than shown. In those areas where daylight saving time is not observed the (-4DT) and ‡ will not be shown. Daylight saving time is in effect from 0200 local time the second Sunday in March to 0200 local time the first Sunday in November. Canada and all U.S. Conterminous States observe daylight saving time except Arizona and Puerto Rico, and the Virgin Islands. If the state observes daylight saving time and the operating times are other than daylight saving times, the operating hours will include the dates, times and no ‡ symbol will be shown, i.e., April 15-Aug 31 0630-1700Z, Sep 1-Apr 14 0600-1700Z.

LEGEND 4.—Airport/Facility Directory.



## AIRPORT/FACILITY DIRECTORY LEGEND

15

**⑦ GEOGRAPHIC POSITION OF AIRPORT—AIRPORT REFERENCE POINT (ARP)**

Positions are shown as hemisphere, degrees, minutes and hundredths of a minute and represent the approximate geometric center of all usable runway surfaces.

**⑧ CHARTS**

Charts refer to the Sectional Chart and Low and High Altitude Enroute Chart and panel on which the airport or facility is located. Helicopter Chart locations will be indicated as COPTER. IFR Gulf of Mexico West and IFR Gulf of Mexico Central will be depicted as GOMW and GOMC.

**⑨ INSTRUMENT APPROACH PROCEDURES, AIRPORT DIAGRAMS**

IAP indicates an airport for which a prescribed (Public Use) FAA Instrument Approach Procedure has been published. DIAP indicates an airport for which a prescribed DoD Instrument Approach Procedure has been published in the U.S. Terminal Procedures. See the Special Notice Section of this directory, Civil Use of Military Fields and the Aeronautical Information Manual 5-4-5 Instrument Approach Procedure Charts for additional information. AD indicates an airport for which an airport diagram has been published. Airport diagrams are located in the back of each Chart Supplement volume alphabetically by associated city and airport name.

**⑩ AIRPORT SKETCH**

The airport sketch, when provided, depicts the airport and related topographical information as seen from the air and should be used in conjunction with the text. It is intended as a guide for pilots in VFR conditions. Symbology that is not self-explanatory will be reflected in the sketch legend. The airport sketch will be oriented with True North at the top. Airport sketches will be added incrementally.

**⑪ ELEVATION**

The highest point of an airport's usable runways measured in feet from mean sea level. When elevation is sea level it will be indicated as "00". When elevation is below sea level a minus "-" sign will precede the figure.

**⑫ ROTATING LIGHT BEACON**

B indicates rotating beacon is available. Rotating beacons operate sunset to sunrise unless otherwise indicated in the AIRPORT REMARKS or MILITARY REMARKS segment of the airport entry.

**⑬ TRAFFIC PATTERN ALTITUDE**

Traffic Pattern Altitude (TPA)—The first figure shown is TPA above mean sea level. The second figure in parentheses is TPA above airport elevation. Multiple TPA shall be shown as "TPA—See Remarks" and detailed information shall be shown in the Airport or Military Remarks Section. Traffic pattern data for USAF bases, USN facilities, and U.S. Army airports (including those on which ACC or U.S. Army is a tenant) that deviate from standard pattern altitudes shall be shown in Military Remarks.

**⑭ AIRPORT OF ENTRY, LANDING RIGHTS, AND CUSTOMS USER FEE AIRPORTS**

U.S. CUSTOMS USER FEE AIRPORT—Private Aircraft operators are frequently required to pay the costs associated with customs processing.

AOE—Airport of Entry. A customs Airport of Entry where permission from U.S. Customs is not required to land. However, at least one hour advance notice of arrival is required.

LRA—Landing Rights Airport. Application for permission to land must be submitted in advance to U.S. Customs. At least one hour advance notice of arrival is required.

NOTE: Advance notice of arrival at both an AOE and LRA airport may be included in the flight plan when filed in Canada or Mexico. Where Flight Notification Service (ADCUS) is available the airport remark will indicate this service. This notice will also be treated as an application for permission to land in the case of an LRA. Although advance notice of arrival may be relayed to Customs through Mexico, Canada, and U.S. Communications facilities by flight plan, the aircraft operator is solely responsible for ensuring that Customs receives the notification. (See Customs, Immigration and Naturalization, Public Health and Agriculture Department requirements in the International Flight Information Manual for further details.)

## U.S. CUSTOMS AIR AND SEA PORTS, INSPECTORS AND AGENTS

Northeast Sector (New England and Atlantic States—ME to MD)	407-975-1740
Southeast Sector (Atlantic States—DC, WV, VA to FL)	407-975-1780
Central Sector (Interior of the US, including Gulf states—MS, AL, LA)	407-975-1760
Southwest East Sector (OK and eastern TX)	407-975-1840
Southwest West Sector (Western TX, NM and AZ)	407-975-1820
Pacific Sector (WA, OR, CA, HI and AK)	407-975-1800

**⑮ CERTIFICATED AIRPORT (14 CFR PART 139)**

Airports serving Department of Transportation certified carriers and certified under 14 CFR part 139 are indicated by the Class and the ARFF Index; e.g. Class I, ARFF Index A, which relates to the availability of crash, fire, rescue equipment. Class I airports can have an ARFF Index A through E, depending on the aircraft length and scheduled departures. Class II, III, and IV will always carry an Index A.

## AIRPORT CLASSIFICATIONS

Type of Air Carrier Operation	Class I	Class II	Class III	Class IV
Scheduled Air Carrier Aircraft with 31 or more passenger seats	X			
Unscheduled Air Carrier Aircraft with 31 or more passengers seats	X	X		X
Scheduled Air Carrier Aircraft with 10 to 30 passenger seats	X	X	X	

LEGEND 5.—Airport/Facility Directory.

16

**AIRPORT/FACILITY DIRECTORY LEGEND**

INDICES AND AIRCRAFT RESCUE AND FIRE FIGHTING EQUIPMENT REQUIREMENTS

Airport Index	Required No. Vehicles	Aircraft Length	Scheduled Departures	Agent + Water for Foam
A	1	<90'	≥1	500#DC or HALON 1211 or 450#DC + 100 gal H <sub>2</sub> O
B	1 or 2	≥90', <126'	≥5	Index A + 1500 gal H <sub>2</sub> O
		≥126', <159'	<5	
C	2 or 3	≥126', <159'	≥5	Index A + 3000 gal H <sub>2</sub> O
		≥159', <200'	<5	
D	3	≥159', <200'	—	Index A + 4000 gal H <sub>2</sub> O
		>200'	<5	
E	3	≥200'	≥5	Index A + 6000 gal H <sub>2</sub> O

> Greater Than; < Less Than; ≥ Equal or Greater Than; ≤ Equal or Less Than; H<sub>2</sub>O—Water; DC—Dry Chemical.

NOTE: The listing of ARFF index does not necessarily assure coverage for non-air carrier operations or at other than prescribed times for air carrier. ARFF Index Ltd.—indicates ARFF coverage may or may not be available, for information contact airport manager prior to flight.

**16 NOTAM SERVICE**

All public use landing areas are provided NOTAM service. A NOTAM FILE identifier is shown for individual landing areas, e.g., "NOTAM FILE BNA". See the AIM, Basic Flight Information and ATC Procedures for a detailed description of NOTAMS. Current NOTAMS are available from flight service stations at 1-800-WX-BRIEF (992-7433) or online through the FAA PilotWeb at <https://pilotweb.nas.faa.gov>. Military NOTAMS are available using the Defense Internet NOTAM Service (DINS) at <https://www.notams.faa.gov>. Pilots flying to or from airports not available through the FAA PilotWeb or DINS can obtain assistance from Flight Service.

**17 FAA INSPECTION**

All airports not inspected by FAA will be identified by the note: Not insp. This indicates that the airport information has been provided by the owner or operator of the field.

**18 RUNWAY DATA**

Runway information is shown on two lines. That information common to the entire runway is shown on the first line while information concerning the runway ends is shown on the second or following line. Runway direction, surface, length, width, weight bearing capacity, lighting, and slope, when available are shown for each runway. Multiple runways are shown with the longest runway first. Direction, length, width, and lighting are shown for sea-lanes. The full dimensions of helipads are shown, e.g., 50X150. Runway data that requires clarification will be placed in the remarks section.

**RUNWAY DESIGNATION**

Runways are normally numbered in relation to their magnetic orientation rounded off to the nearest 10 degrees. Parallel runways can be designated L (left)/R (right)/C (center). Runways may be designated as Ultralight or assault strips. Assault strips are shown by magnetic bearing.

**RUNWAY DIMENSIONS**

Runway length and width are shown in feet. Length shown is runway end to end including displaced thresholds, but excluding those areas designed as overruns.

**RUNWAY SURFACE AND SURFACE TREATMENT**

Runway lengths prefixed by the letter "H" indicate that the runways are hard surfaced (concrete, asphalt, or part asphalt-concrete). If the runway length is not prefixed, the surface is sod, clay, etc. The runway surface composition is indicated in parentheses after runway length as follows:

- |   |  |                  |
|---|--|------------------|
| (AFSC)—Aggregate friction seal coat                       | (GRVL)—Gravel, or cinders                              | (SAND)—Sand      |
| (AM2)—Temporary metal planks coated with nonskid material | (MATS)—Pierced steel planking, landing mats, membranes | (TURF)—Turf      |
| (ASPH)—Asphalt  | (PEM)—Part concrete, part asphalt                      | (TRTD)—Treated   |
| (CONC)—Concrete   | (PFC)—Porous friction courses                          | (WC)—Wire combed |
| (DIRT)—Dirt   | (PSP)—Pierced steel plank                              |                  |
| (GRVD)—Grooved  | (RFSC)—Rubberized friction seal coat                   |                  |

LEGEND 6.—Airport/Facility Directory.

## AIRPORT/FACILITY DIRECTORY LEGEND

17

## RUNWAY WEIGHT BEARING CAPACITY

Runway strength data shown in this publication is derived from available information and is a realistic estimate of capability at an average level of activity. It is not intended as a maximum allowable weight or as an operating limitation. Many airport pavements are capable of supporting limited operations with gross weights in excess of the published figures. Permissible operating weights, insofar as runway strengths are concerned, are a matter of agreement between the owner and user. When desiring to operate into any airport at weights in excess of those published in the publication, users should contact the airport management for permission. Runway strength figures are shown in thousand of pounds, with the last three figures being omitted. Add 000 to figure following S, D, 2S, 2T, AUW, SWL, etc., for gross weight capacity. A blank space following the letter designator is used to indicate the runway can sustain aircraft with this type landing gear, although definite runway weight bearing capacity figures are not available, e.g., S, D. Applicable codes for typical gear configurations with S=Single, D=Dual, T=Triple and Q=Quadruple:

CURRENT	NEW	NEW DESCRIPTION
S	S	Single wheel type landing gear (DC3), (C47), (F15), etc.
D	D	Dual wheel type landing gear (BE1900), (B737), (A319), etc.
T	D	Dual wheel type landing gear (P3, C9).
ST	2S	Two single wheels in tandem type landing gear (C130).
TRT	2T	Two triple wheels in tandem type landing gear (C17), etc.
DT	2D	Two dual wheels in tandem type landing gear (B707), etc.
TT	2D	Two dual wheels in tandem type landing gear (B757, KC135).
SBTT	2D/D1	Two dual wheels in tandem/dual wheel body gear type landing gear (KC10).
None	2D/2D1	Two dual wheels in tandem/two dual wheels in tandem body gear type landing gear (A340–600).
DDT	2D/2D2	Two dual wheels in tandem/two dual wheels in double tandem body gear type landing gear (B747, E4).
TTT	3D	Three dual wheels in tandem type landing gear (B777), etc.
TT	D2	Dual wheel gear two struts per side main gear type landing gear (B52).
TDT	C5	Complex dual wheel and quadruple wheel combination landing gear (C5).

AUW—All up weight. Maximum weight bearing capacity for any aircraft irrespective of landing gear configuration.

SWL—Single Wheel Loading. (This includes information submitted in terms of Equivalent Single Wheel Loading (ESWL) and Single Isolated Wheel Loading).

PSI—Pounds per square inch. PSI is the actual figure expressing maximum pounds per square inch runway will support, e.g., (SWL 000/PSI 535).

Omission of weight bearing capacity indicates information unknown.

The ACN/PCN System is the ICAO standard method of reporting pavement strength for pavements with bearing strengths greater than 12,500 pounds. The Pavement Classification Number (PCN) is established by an engineering assessment of the runway. The PCN is for use in conjunction with an Aircraft Classification Number (ACN). Consult the Aircraft Flight Manual, Flight Information Handbook, or other appropriate source for ACN tables or charts. Currently, ACN data may not be available for all aircraft. If an ACN table or chart is available, the ACN can be calculated by taking into account the aircraft weight, the pavement type, and the subgrade category. For runways that have been evaluated under the ACN/PCN system, the PCN will be shown as a five-part code (e.g. PCN 80 R/B/W/T). Details of the coded format are as follows:

NOTE: Prior permission from the airport controlling authority is required when the ACN of the aircraft exceeds the published PCN or aircraft tire pressure exceeds the published limits.

- (1) The PCN NUMBER—The reported PCN indicates that an aircraft with an ACN equal or less than the reported PCN can operate on the pavement subject to any limitation on the tire pressure.
- (2) The type of pavement:
  - R — Rigid
  - F — Flexible
- (3) The pavement subgrade category:
  - A — High
  - B — Medium
  - C — Low
  - D — Ultra-low
- (4) The maximum tire pressure authorized for the pavement:
  - W — Unlimited, no pressure limit
  - X — High, limited to 254 psi (1.75 MPa)
  - Y — Medium, limited to 181 psi (1.25MPa)
  - Z — Low, limited to 73 psi (0.50 MPa)
- (5) Pavement evaluation method:
  - T — Technical evaluation
  - U — By experience of aircraft using the pavement

## RUNWAY LIGHTING

Lights are in operation sunset to sunrise. Lighting available by prior arrangement only or operating part of the night and/or pilot controlled lighting with specific operating hours are indicated under airport or military remarks. At USN/USMC facilities lights are available only during airport hours of operation. Since obstructions are usually lighted, obstruction lighting is not included in this code. Unlighted obstructions on or surrounding an airport will be noted in airport or military remarks. Runway lights nonstandard (NSTD) are systems for which the light fixtures are not FAA approved L-800 series: color, intensity, or spacing does not meet FAA standards. Nonstandard runway lights, VASI, or any other system not listed below will be shown in airport remarks or military

18

**AIRPORT/FACILITY DIRECTORY LEGEND**

service. Temporary, emergency or limited runway edge lighting such as flares, smudge pots, lanterns or portable runway lights will also be shown in airport remarks or military service. Types of lighting are shown with the runway or runway end they serve.

- |   |   |
|---|---|
| NSTD—Light system fails to meet FAA standards.  | SALS—Short Approach Lighting System.  |
| LIRL—Low Intensity Runway Lights.   | SALSF—Short Approach Lighting System with Sequenced Flashing Lights.                                      |
| MIRL—Medium Intensity Runway Lights.  | SSALS—Simplified Short Approach Lighting System.  |
| HIRL—High Intensity Runway Lights.  | SSALF—Simplified Short Approach Lighting System with Sequenced Flashing Lights.                           |
| RAIL—Runway Alignment Indicator Lights.   | SSALR—Simplified Short Approach Lighting System with Runway Alignment Indicator Lights.                   |
| REIL—Runway End Identifier Lights.  | ALSAF—High Intensity Approach Lighting System with Sequenced Flashing Lights.                             |
| CL—Centerline Lights.   | ALSF1—High Intensity Approach Lighting System with Sequenced Flashing Lights, Category I, Configuration.  |
| TDZL—Touchdown Zone Lights.   | ALSF2—High Intensity Approach Lighting System with Sequenced Flashing Lights, Category II, Configuration. |
| ODALS—Omni Directional Approach Lighting System.  | SF—Sequenced Flashing Lights.   |
| AF OVRN—Air Force Overrun 1000' Standard Approach Lighting System.                      | OLS—Optical Landing System.   |
| MALS—Medium Intensity Approach Lighting System.   | WAVE—OFF.   |
| MALSF—Medium Intensity Approach Lighting System with Sequenced Flashing Lights.         |   |
| MALSR—Medium Intensity Approach Lighting System with Runway Alignment Indicator Lights. |   |
| RLLS—Runway Lead-in Light System  |   |

NOTE: Civil ALSF2 may be operated as SSALR during favorable weather conditions. When runway edge lights are positioned more than 10 feet from the edge of the usable runway surface a remark will be added in the "Remarks" portion of the airport entry. This is applicable to Air Force, Air National Guard and Air Force Reserve Bases, and those joint use airfields on which they are tenants.

**VISUAL GLIDESLOPE INDICATORS**

- APAP—A system of panels, which may or may not be lighted, used for alignment of approach path.
- |      |                             |      |                              |
|------|-----------------------------|------|------------------------------|
| PNIL | APAP on left side of runway | PNIR | APAP on right side of runway |
|------|-----------------------------|------|------------------------------|
- PAPI—Precision Approach Path Indicator
- |     |  |     |  |
|-----|--|-----|--|
| P2L | 2-identical light units placed on left side of runway  | P4L | 4-identical light units placed on left side of runway  |
| P2R | 2-identical light units placed on right side of runway | P4R | 4-identical light units placed on right side of runway |
- PVASI—Pulsating/steady burning visual approach slope indicator, normally a single light unit projecting two colors.
- |      |                              |      |                               |
|------|------------------------------|------|-------------------------------|
| PSIL | PVASI on left side of runway | PSIR | PVASI on right side of runway |
|------|------------------------------|------|-------------------------------|
- SAVASI—Simplified Abbreviated Visual Approach Slope Indicator
- |     |                                     |     |                                      |
|-----|-------------------------------------|-----|--------------------------------------|
| S2L | 2-box SAVASI on left side of runway | S2R | 2-box SAVASI on right side of runway |
|-----|-------------------------------------|-----|--------------------------------------|
- TRCV—Tri-color visual approach slope indicator, normally a single light unit projecting three colors.
- |      |                             |      |                              |
|------|-----------------------------|------|------------------------------|
| TRIL | TRCV on left side of runway | TRIR | TRCV on right side of runway |
|------|-----------------------------|------|------------------------------|
- VASI—Visual Approach Slope Indicator
- |     |                                    |     |                                     |
|-----|------------------------------------|-----|-------------------------------------|
| V2L | 2-box VASI on left side of runway  | V6L | 6-box VASI on left side of runway   |
| V2R | 2-box VASI on right side of runway | V6R | 6-box VASI on right side of runway  |
| V4L | 4-box VASI on left side of runway  | V12 | 12-box VASI on both sides of runway |
| V4R | 4-box VASI on right side of runway | V16 | 16-box VASI on both sides of runway |

NOTE: Approach slope angle and threshold crossing height will be shown when available; i.e., -GA 3.5° TCH 37'.

**PILOT CONTROL OF AIRPORT LIGHTING**

- | Key Mike                 | Function  |
|--------------------------|---|
| 7 times within 5 seconds | Highest intensity available                         |
| 5 times within 5 seconds | Medium or lower intensity (Lower REIL or REIL-Off)  |
| 3 times within 5 seconds | Lowest intensity available (Lower REIL or REIL-Off) |

Available systems will be indicated in the Service section, e.g., LGT ACTIVATE HIRL Rwy 07-25, MALSR Rwy 07, and VASI Rwy 07-122.8.

Where the airport is not served by an instrument approach procedure and/or has an independent type system of different specification installed by the airport sponsor, descriptions of the type lights, method of control, and operating frequency will be explained in clear text. See AIM, "Basic Flight Information and ATC Procedures," for detailed description of pilot control of airport lighting.

**RUNWAY SLOPE**

When available, runway slope data will be provided. Runway slope will be shown only when it is 0.3 percent or greater. On runways less than 8000 feet, the direction of the slope up will be indicated, e.g., 0.3% up NW. On runways 8000 feet or greater, the slope will be shown (up or down) on the runway end line, e.g., RWY 13: 0.3% up., RWY 31: Pole. Rgt t/c. 0.4% down.

## AIRPORT/FACILITY DIRECTORY LEGEND

19

## RUNWAY END DATA

Information pertaining to the runway approach end such as approach lights, touchdown zone lights, runway end identification lights, visual glideslope indicators, displaced thresholds, controlling obstruction, and right hand traffic pattern, will be shown on the specific runway end. "Rgt tfc"—Right traffic indicates right turns should be made on landing and takeoff for specified runway end. Runway Visual Range shall be shown as "RVR" appended with "T" for touchdown, "M" for midpoint, and "R" for rollout; e.g., RVR-TMR.

**19 LAND AND HOLD—SHORT OPERATIONS (LAHSO)**

LAHSO is an acronym for "Land and Hold—Short Operations" These operations include landing and holding short of an intersection runway, an intersecting taxiway, or other predetermined points on the runway other than a runway or taxiway. Measured distance represents the available landing distance on the landing runway, in feet.

Specific questions regarding these distances should be referred to the air traffic manager of the facility concerned. The Aeronautical Information Manual contains specific details on hold—short operations and markings.

**20 RUNWAY DECLARED DISTANCE INFORMATION**

TORA—Take-off Run Available. The length of runway declared available and suitable for the ground run of an aeroplane take-off.

TODA—Take-off Distance Available. The length of the take-off run available plus the length of the clearway, if provided.

ASDA—Accelerate—Stop Distance Available. The length of the take-off run available plus the length of the stopway, if provided.

LDA—Landing Distance Available. The length of runway which is declared available and suitable for the ground run of an aeroplane landing.

**21 ARRESTING GEAR/SYSTEMS**

Arresting gear is shown as it is located on the runway. The a-gear distance from the end of the appropriate runway (or into the overrun) is indicated in parentheses. A—Gear which has a bi-direction capability and can be utilized for emergency approach end engagement is indicated by a (B). Up to 15 minutes advance notice may be required for rigging A—Gear for approach and engagement. Airport listing may show availability of other than US Systems. This information is provided for emergency requirements only. Refer to current aircraft operating manuals for specific engagement weight and speed criteria based on aircraft structural restrictions and arresting system limitations.

Following is a list of current systems referenced in this publication identified by both Air Force and Navy terminology:

## BI-DIRECTIONAL CABLE (B)

<u>TYPE</u>	<u>DESCRIPTION</u>
BAK-9	Rotary friction brake.
BAK-12A	Standard BAK-12 with 950 foot run out, 1-inch cable and 40,000 pound weight setting. Rotary friction brake.
BAK-12B	Extended BAK-12 with 1200 foot run, 1¼ inch Cable and 50,000 pounds weight setting. Rotary friction brake.
E28	Rotary Hydraulic (Water Brake).
M21	Rotary Hydraulic (Water Brake) Mobile.

The following device is used in conjunction with some aircraft arresting systems:

BAK-14	A device that raises a hook cable out of a slot in the runway surface and is remotely positioned for engagement by the tower on request. (In addition to personnel reaction time, the system requires up to five seconds to fully raise the cable.)
H	A device that raises a hook cable out of a slot in the runway surface and is remotely positioned for engagement by the tower on request. (In addition to personnel reaction time, the system requires up to one and one-half seconds to fully raise the cable.)

## UNI-DIRECTIONAL CABLE

<u>TYPE</u>	<u>DESCRIPTION</u>
MB60	Textile brake—an emergency one-time use, modular braking system employing the tearing of specially woven textile straps to absorb the kinetic energy.
E5/E5-1/E5-3	Chain Type. At USN/USMC stations E-5 A-GEAR systems are rated, e.g., E-5 RATING-13R-1100 HW (DRY), 31L/R-1200 STD (WET). This rating is a function of the A-GEAR chain weight and length and is used to determine the maximum aircraft engaging speed. A dry rating applies to a stabilized surface (dry or wet) while a wet rating takes into account the amount (if any) of wet overrun that is not capable of withstanding the aircraft weight. These ratings are published under Service/Military/A-Gear in the entry.

## FOREIGN CABLE

<u>TYPE</u>	<u>DESCRIPTION</u>	<u>US EQUIVALENT</u>
44B-3H	Rotary Hydraulic (Water Brake)	
CHAG	Chain	E-5

## UNI-DIRECTIONAL BARRIER

<u>TYPE</u>	<u>DESCRIPTION</u>
MA-1A	Web barrier between stanchions attached to a chain energy absorber.
BAK-15	Web barrier between stanchions attached to an energy absorber (water squeezer, rotary friction, chain). Designed for wing engagement.

NOTE: Landing short of the runway threshold on a runway with a BAK-15 in the overrun is a significant hazard. The barrier in the down position still protrudes several inches above the overrun. Aircraft contact with the barrier short of the runway threshold can cause damage to the barrier and substantial damage to the aircraft.

## OTHER

<u>TYPE</u>	<u>DESCRIPTION</u>
EMAS	Engineered Material Arresting System, located beyond the departure end of the runway, consisting of high energy absorbing materials which will crush under the weight of an aircraft.

LEGEND 9.—Airport/Facility Directory.

**AIRPORT/FACILITY DIRECTORY LEGEND**

**22 SERVICE**

**SERVICING—CIVIL**

- |  |  |
|--|--|
| S1: Minor airframe repairs.                      | S5: Major airframe repairs.                      |
| S2: Minor airframe and minor powerplant repairs. | S6: Minor airframe and major powerplant repairs. |
| S3: Major airframe and minor powerplant repairs. | S7: Major powerplant repairs.                    |
| S4: Major airframe and major powerplant repairs. | S8: Minor powerplant repairs.                    |

**FUEL—CIVIL**

<b>CODE</b>	<b>FUEL</b>	<b>CODE</b>	<b>FUEL</b>
80	Grade 80 gasoline (Red)	A1+	Jet A-1, Kerosene with FS-II*, FP** minus 47° C.
100	Grade 100 gasoline (Green)	B	Jet B, Wide-cut, turbine fuel without FS-II*, FP** minus 50° C.
100LL	100LL gasoline (low lead) (Blue)	B+	Jet B, Wide-cut, turbine fuel with FS-II*, FP** minus 50° C
115	Grade 115 gasoline (115/145 military specification) (Purple)	J4 (JP4)	(JP-4 military specification) FP** minus 58° C.
A	Jet A, Kerosene, without FS-II*, FP** minus 40° C.	J5 (JP5)	(JP-5 military specification) Kerosene with FS-II, FP** minus 46° C.
A+	Jet A, Kerosene, with FS-II*, FP** minus 40° C.	J8 (JP8)	(JP-8 military specification) Jet A-1, Kerosene with FS-II*, Cl/LI#, SDA##, FP** minus 47° C.
A++	Jet A, Kerosene, with FS-II*, Cl/LI#, SDA##, FP** minus 40° C.	J8+100	(JP-8 military specification) Jet A-1, Kerosene with FS-II*, Cl/LI#, SDA##, FP** minus 47° C, with +100 fuel additive that improves thermal stability characteristics of kerosene jet fuels.
A++100	Jet A, Kerosene, with FS-II*, Cl/LI#, SDA##, FP** minus 40° C, with +100 fuel additive that improves thermal stability characteristics of kerosene jet fuels.	J	(Jet Fuel Type Unknown)
A1	Jet A-1, Kerosene, without FS-II*, FP** minus 47° C.	MOGAS	Automobile gasoline which is to be used as aircraft fuel.

\*(Fuel System Icing Inhibitor) \*\* (Freeze Point) # (Corrosion Inhibitors/Lubricity Improvers) ## (Static Dissipator Additive)

**NOTE:** Certain automobile gasoline may be used in specific aircraft engines if a FAA supplemental type certificate has been obtained. Automobile gasoline, which is to be used in aircraft engines, will be identified as "MOGAS", however, the grade/type and other octane rating will not be published.

Data shown on fuel availability represents the most recent information the publisher has been able to acquire. Because of a variety of factors, the fuel listed may not always be obtainable by transient civil pilots. Confirmation of availability of fuel should be made directly with fuel suppliers at locations where refueling is planned.

**OXYGEN—CIVIL**

- |                    |  |
|--------------------|--|
| OX 1 High Pressure | OX 3 High Pressure—Replacement Bottles |
| OX 2 Low Pressure  | OX 4 Low Pressure—Replacement Bottles  |

**SERVICE—MILITARY**

Specific military services available at the airport are listed under this general heading. Remarks applicable to any military service are shown in the individual service listing.

**JET AIRCRAFT STARTING UNITS (JASU)—MILITARY**

The numeral preceding the type of unit indicates the number of units available. The absence of the numeral indicates ten or more units available. If the number of units is unknown, the number one will be shown. Absence of JASU designation indicates non-availability.

The following is a list of current JASU systems referenced in this publication:

**USAF JASU (For variations in technical data, refer to T.O. 35-1-7.)**

**ELECTRICAL STARTING UNITS:**

A/M32A-86	AC: 115/200v, 3 phase, 90 kva, 0.8 pf, 4 wire DC: 28v, 1500 amp, 72 kw (with TR pack)
MC-1A	AC: 115/208v, 400 cycle, 3 phase, 37.5 kva, 0.8 pf, 108 amp, 4 wire DC: 28v, 500 amp, 14 kw
MD-3	AC: 115/208v, 400 cycle, 3 phase, 60 kva, 0.75 pf, 4 wire DC: 28v, 1500 amp, 45 kw, split bus
MD-3A	AC: 115/208v, 400 cycle, 3 phase, 60 kva, 0.75 pf, 4 wire DC: 28v, 1500 amp, 45 kw, split bus
MD-3M	AC: 115/208v, 400 cycle, 3 phase, 60 kva, 0.75 pf, 4 wire DC: 28v, 500 amp, 15 kw
MD-4	AC: 120/208v, 400 cycle, 3 phase, 62.5 kva, 0.8 pf, 175 amp, "WYE" neutral ground, 4 wire, 120v, 400 cycle, 3 phase, 62.5 kva, 0.8 pf, 303 amp, "DELTA" 3 wire, 120v, 400 cycle, 1 phase, 62.5 kva, 0.8 pf, 520 amp, 2 wire

## AIRPORT/FACILITY DIRECTORY LEGEND

21

## AIR STARTING UNITS

AM32-95	150 +/- 5 lb/min (2055 +/- 68 cfm) at 51 +/- 2 psia
AM32A-95	150 +/- 5 lb/min @ 49 +/- 2 psia (35 +/- 2 psig)
LASS	150 +/- 5 lb/min @ 49 +/- 2 psia
MA-1A	82 lb/min (1123 cfm) at 130° air inlet temp, 45 psia (min) air outlet press
MC-1	15 cfm, 3500 psia
MC-1A	15 cfm, 3500 psia
MC-2A	15 cfm, 200 psia
MC-11	8,000 cu in cap, 4000 psig, 15 cfm

## COMBINED AIR AND ELECTRICAL STARTING UNITS:

AGPU	AC: 115/200v, 400 cycle, 3 phase, 30 kw gen DC: 28v, 700 amp AIR: 60 lb/min @ 40 psig @ sea level
AM32A-60*	AIR: 120 +/- 4 lb/min (1644 +/- 55 cfm) at 49 +/- 2 psia AC: 120/208v, 400 cycle, 3 phase, 75 kva, 0.75 pf, 4 wire, 120v, 1 phase, 25 kva DC: 28v, 500 amp, 15 kw
AM32A-60A	AIR: 150 +/- 5 lb/min (2055 +/- 68 cfm at 51 +/- psia AC: 120/208v, 400 cycle, 3 phase, 75 kva, 0.75 pf, 4 wire DC: 28v, 200 amp, 5.6 kw
AM32A-60B*	AIR: 130 lb/min, 50 psia AC: 120/208v, 400 cycle, 3 phase, 75 kva, 0.75 pf, 4 wire DC: 28v, 200 amp, 5.6 kw

\*NOTE: During combined air and electrical loads, the pneumatic circuitry takes preference and will limit the amount of electrical power available.

## USN JASU

## ELECTRICAL STARTING UNITS:

NC-8A/A1	DC: 500 amp constant, 750 amp intermittent, 28v; AC: 60 kva @ .8 pf, 115/200v, 3 phase, 400 Hz.
NC-10A/A1/B/C	DC: 750 amp constant, 1000 amp intermittent, 28v; AC: 90 kva, 115/200v, 3 phase, 400 Hz.

## AIR STARTING UNITS:

GTC-85/GTE-85	120 lbs/min @ 45 psi.
MSU-200NAV/A/U47A-5	204 lbs/min @ 56 psia.
WELLS AIR START SYSTEM	180 lbs/min @ 75 psi or 120 lbs/min @ 45 psi. Simultaneous multiple start capability.

## COMBINED AIR AND ELECTRICAL STARTING UNITS:

NCPP-105/RCPT	180 lbs/min @ 75 psi or 120 lbs/min @ 45 psi. 700 amp, 28v DC. 120/208v, 400 Hz AC, 30 kva.
---------------	---

## ARMY JASU

59B2-1B	28v, 7.5 kw, 280 amp.
---------	-----------------------

## OTHER JASU

## ELECTRICAL STARTING UNITS (DND):

CE12	AC 115/200v, 140 kva, 400 Hz, 3 phase
CE13	AC 115/200v, 60 kva, 400 Hz, 3 phase
CE14	AC/DC 115/200v, 140 kva, 400 Hz, 3 phase, 28vDC, 1500 amp
CE15	DC 22-35v, 500 amp continuous 1100 amp intermittent
CE16	DC 22-35v, 500 amp continuous 1100 amp intermittent soft start

## AIR STARTING UNITS (DND):

CA2	ASA 45.5 psig, 116.4 lb/min
-----	-----------------------------

## COMBINED AIR AND ELECTRICAL STARTING UNITS (DND)

CEA1	AC 120/208v, 60 kva, 400 Hz, 3 phase DC 28v, 75 amp AIR 112.5 lb/min, 47 psig
------	--

## ELECTRICAL STARTING UNITS (OTHER)

C-26	28v 45kw 115-200v 15kw 380-800 Hz 1 phase 2 wire
C-26-B, C-26-C	28v 45kw: Split Bus: 115-200v 15kw 380-800 Hz 1 phase 2 wire
E3	DC 28v/10kw

## AIR STARTING UNITS (OTHER):

A4	40 psi/2 lb/sec (LPAS Mk12, Mk12L, Mk12A, Mk1, Mk2B)
MA-1	150 Air HP, 115 lb/min 50 psia
MA-2	250 Air HP, 150 lb/min 75 psia

## CARTRIDGE:

MXU-4A	USAF
--------	------

LEGEND 11.—Airport/Facility Directory.

## AIRPORT/FACILITY DIRECTORY LEGEND

## FUEL—MILITARY

Fuel available through US Military Base supply, DESC Into-Plane Contracts and/or reciprocal agreement is listed first and is followed by (Mil). At commercial airports where Into-Plane contracts are in place, the name of the refueling agent is shown. Military fuel should be used first if it is available. When military fuel cannot be obtained but Into-Plane contract fuel is available, Government aircraft must refuel with the contract fuel and applicable refueling agent to avoid any breach in contract terms and conditions. Fuel not available through the above is shown preceded by NC (no contract). When fuel is obtained from NC sources, local purchase procedures must be followed. The US Military Aircraft Identaplates DD Form 1896 (Jet Fuel), DD Form 1897 (Avgas) and AF Form 1245 (Avgas) are used at military installations only. The US Government Aviation Into-Plane Reimbursement (AIR) Card (currently issued by AVCARD) is the instrument to be used to obtain fuel under a DESC Into-Plane Contract and for NC purchases if the refueling agent at the commercial airport accepts the AVCARD. A current list of contract fuel locations is available online at [https://cis.energy.dla.mil/ip\\_cis/](https://cis.energy.dla.mil/ip_cis/). See legend item 14 for fuel code and description.

## SUPPORTING FLUIDS AND SYSTEMS—MILITARY

## CODE

ADI	Anti-Detonation Injection Fluid—Reciprocating Engine Aircraft.
W	Water Thrust Augmentation—Jet Aircraft.
WAI	Water-Alcohol Injection Type, Thrust Augmentation—Jet Aircraft.
SP	Single Point Refueling.
PRESAIR	Air Compressors rated 3,000 PSI or more.
De-Ice	Anti-icing/De-icing/Defrosting Fluid (MIL-A-8243).

## OXYGEN:

LPOX	Low pressure oxygen servicing.
HPOX	High pressure oxygen servicing.
LHOX	Low and high pressure oxygen servicing.
LOX	Liquid oxygen servicing.
OXR	Oxygen replacement bottles. (Maintained primarily at Naval stations for use in acft where oxygen can be replenished only by replacement of cylinders.)
OX	Indicates oxygen servicing when type of servicing is unknown.

NOTE: Combinations of above items is used to indicate complete oxygen servicing available;

LHOXRB	Low and high pressure oxygen servicing and replacement bottles;
LPOXRB	Low pressure oxygen replacement bottles only, etc.

NOTE: Aircraft will be serviced with oxygen procured under military specifications only. Aircraft will not be serviced with medical oxygen.

## NITROGEN:

LPNIT	Low pressure nitrogen servicing.
HPNIT	High pressure nitrogen servicing.
LHNIT	Low and high pressure nitrogen servicing.

## OIL—MILITARY

## US AVIATION OILS (MIL SPECS):

CODE	GRADE, TYPE
O-113	1065, Reciprocating Engine Oil (MIL-L-6082)
O-117	1100, Reciprocating Engine Oil (MIL-L-6082)
O-117+	1100, O-117 plus cyclohexanone (MIL-L-6082)
O-123	1065, (Dispersant), Reciprocating Engine Oil (MIL-L-22851 Type III)
O-128	1100, (Dispersant), Reciprocating Engine Oil (MIL-L-22851 Type II)
O-132	1005, Jet Engine Oil (MIL-L-6081)
O-133	1010, Jet Engine Oil (MIL-L-6081)
O-147	None, MIL-L-6085A Lubricating Oil, Instrument, Synthetic
O-148	None, MIL-L-7808 (Synthetic Base) Turbine Engine Oil
O-149	None, Aircraft Turbine Engine Synthetic, 7.5c St
O-155	None, MIL-L-6086C, Aircraft, Medium Grade
O-156	None, MIL-L-23699 (Synthetic Base), Turboprop and Turboshaft Engines
JOAP/SOAP	Joint Oil Analysis Program. JOAP support is furnished during normal duty hours, other times on request. (JOAP and SOAP programs provide essentially the same service, JOAP is now the standard joint service supported program.)

## TRANSIENT ALERT (TRAN ALERT)—MILITARY

Tran Alert service is considered to include all services required for normal aircraft turn-around, e.g., servicing (fuel, oil, oxygen, etc.), debriefing to determine requirements for maintenance, minor maintenance, inspection and parking assistance of transient aircraft. Drag chute repack, specialized maintenance, or extensive repairs will be provided within the capabilities and priorities of the base. Delays can be anticipated after normal duty hours/holidays/weekends regardless of the hours of transient maintenance operation. Pilots should not expect aircraft to be serviced for TURN-AROUNDS during time periods when servicing or maintenance manpower is not available. In the case of airports not operated exclusively by US military, the servicing indicated by the remarks will not always be available for US military aircraft. When transient alert services are not shown, facilities are unknown. NO PRIORITY BASIS—means that transient alert services will be provided only after all the requirements for mission/tactical assigned aircraft have been accomplished.



## AIRPORT/FACILITY DIRECTORY LEGEND

23

**23 AIRPORT REMARKS**

The Attendance Schedule is the months, days and hours the airport is actually attended. Airport attendance does not mean watchman duties or telephone accessibility, but rather an attendant or operator on duty to provide at least minimum services (e.g., repairs, fuel, transportation).

Airport Remarks have been grouped in order of applicability. Airport remarks are limited to those items of information that are determined essential for operational use, i.e., conditions of a permanent or indefinite nature and conditions that will remain in effect for more than 30 days concerning aeronautical facilities, services, maintenance available, procedures or hazards, knowledge of which is essential for safe and efficient operation of aircraft. Information concerning permanent closing of a runway or taxiway will not be shown. A note "See Special Notices" shall be applied within this remarks section when a special notice applicable to the entry is contained in the Special Notices section of this publication.

Parachute Jumping indicates parachute jumping areas associated with the airport. See Parachute Jumping Area section of this publication for additional Information.

Landing Fee indicates landing charges for private or non-revenue producing aircraft. In addition, fees may be charged for planes that remain over a couple of hours and buy no services, or at major airline terminals for all aircraft.

Note: Unless otherwise stated, remarks including runway ends refer to the runway's approach end.

**24 MILITARY REMARKS**

Joint Civil/Military airports contain both Airport Remarks and Military Remarks. Military Remarks published for these airports are applicable only to the military. Military and joint Military/Civil airports contain only Military Remarks. Remarks contained in this section may not be applicable to civil users. When both sets of remarks exist, the first set is applicable to the primary operator of the airport. Remarks applicable to a tenant on the airport are shown preceded by the tenant organization, i.e., (A) (AF) (N) (ANG), etc. Military airports operate 24 hours unless otherwise specified. Airport operating hours are listed first (airport operating hours will only be listed if they are different than the airport attended hours or if the attended hours are unavailable) followed by pertinent remarks in order of applicability. Remarks will include information on restrictions, hazards, traffic pattern, noise abatement, customs/agriculture/immigration, and miscellaneous information applicable to the Military.

Type of restrictions:

CLOSED: When designated closed, the airport is restricted from use by all aircraft unless stated otherwise. Any closure applying to specific type of aircraft or operation will be so stated. USN/USMC/USAF airports are considered closed during non-operating hours. Closed airports may be utilized during an emergency provided there is a safe landing area.

OFFICIAL BUSINESS ONLY: The airfield is closed to all transient military aircraft for obtaining routine services such as fueling, passenger drop off or pickup, practice approaches, parking, etc. The airfield may be used by aircrews and aircraft if official government business (including civilian) must be conducted on or near the airfield and prior permission is received from the airfield manager.

AF OFFICIAL BUSINESS ONLY OR NAVY OFFICIAL BUSINESS ONLY: Indicates that the restriction applies only to service indicated.

PRIOR PERMISSION REQUIRED (PPR): Airport is closed to transient aircraft unless approval for operation is obtained from the appropriate commander through Chief, Airfield Management or Airfield Operations Officer. Official Business or PPR does not preclude the use of US Military airports as an alternate for IFR flights. If a non-US military airport is used as a weather alternate and requires a PPR, the PPR must be requested and confirmed before the flight departs. The purpose of PPR is to control volume and flow of traffic rather than to prohibit it. Prior permission is required for all aircraft requiring transient alert service outside the published transient alert duty hours. All aircraft carrying hazardous materials must obtain prior permission as outlined in AFJI 11-204, AR 95-27, OPNAVINST 3710.7.

Note: OFFICIAL BUSINESS ONLY AND PPR restrictions are not applicable to Special Air Mission (SAM) or Special Air Resource (SPAR) aircraft providing person or persons on board are designated Code 6 or higher as explained in AFJMAN 11-213, AR 95-11, OPNAVINST 3722-8J. Official Business Only or PPR do not preclude the use of the airport as an alternate for IFR flights.

**25 AIRPORT MANAGER**

The phone number of the airport manager.

**26 WEATHER DATA SOURCES**

Weather data sources will be listed alphabetically followed by their assigned frequencies and/or telephone number and hours of operation.

ASOS—Automated Surface Observing System. Reports the same as an AWOS-3 plus precipitation identification and intensity, and freezing rain occurrence;

AWOS—Automated Weather Observing System

AWOS-A—reports altimeter setting (all other information is advisory only).

AWOS-AV—reports altimeter and visibility.

AWOS-1—reports altimeter setting, wind data and usually temperature, dew point and density altitude.

AWOS-2—reports the same as AWOS-1 plus visibility.

AWOS-3—reports the same as AWOS-1 plus visibility and cloud/ceiling data.

AWOS-3P reports the same as the AWOS-3 system, plus a precipitation identification sensor.

AWOS-3PT reports the same as the AWOS-3 system, plus precipitation identification sensor and a thunderstorm/lightning reporting capability.

**AIRPORT/FACILITY DIRECTORY LEGEND**

AWOS-3T reports the same as AWOS-3 system and includes a thunderstorm/lightning reporting capability.

See AIM, Basic Flight Information and ATC Procedures for detailed description of Weather Data Sources.

AWOS-4—reports same as AWOS-3 system, plus precipitation occurrence, type and accumulation, freezing rain, thunderstorm and runway surface sensors.

HIWAS—See RADIO AIDS TO NAVIGATION

LAWRs—Limited Aviation Weather Reporting Station where observers report cloud height, weather, obstructions to vision, temperature and dewpoint (in most cases), surface wind, altimeter and pertinent remarks.

LLWAS—indicates a Low Level Wind Shear Alert System consisting of a center field and several field perimeter anemometers.

SAWRs—identifies airports that have a Supplemental Aviation Weather Reporting Station available to pilots for current weather information.

SWSL—Supplemental Weather Service Location providing current local weather information via radio and telephone.

TDWR—indicates airports that have Terminal Doppler Weather Radar.

WSP—indicates airports that have Weather System Processor.

When the automated weather source is broadcast over an associated airport NAVAID frequency (see NAVAID line), it shall be indicated by a bold ASOS, AWOS, or HIWAS followed by the frequency, identifier and phone number, if available.

**27 COMMUNICATIONS**

Airport terminal control facilities and radio communications associated with the airport shall be shown. When the call sign is not the same as the airport name the call sign will be shown. Frequencies shall normally be shown in descending order with the primary frequency listed first. Frequencies will be listed, together with sectorization indicated by outbound radials, and hours of operation. Communications will be listed in sequence as follows:

Single Frequency Approach (SFA), Common Traffic Advisory Frequency (CTAF), Aeronautical Advisory Stations (UNICOM) or (AUNICOM), and Automatic Terminal Information Service (ATIS) along with their frequency is shown, where available, on the line following the heading "COMMUNICATIONS." When the CTAF and UNICOM frequencies are the same, the frequency will be shown as CTAF/UNICOM 122.8.

The FSS telephone nationwide is toll free 1-800-WX-BRIEF (1-800-992-7433). When the FSS is located on the field it will be indicated as "on arpt". Frequencies available at the FSS will follow in descending order. Remote Communications Outlet (RCO) providing service to the airport followed by the frequency and FSS RADIO name will be shown when available. FSS's provide information on airport conditions, radio aids and other facilities, and process flight plans. Airport Advisory Service (AAS) is provided on the CTAF by FSS's for select non-tower airports or airports where the tower is not in operation.

(See AIM, Para 4-1-9 Traffic Advisory Practices at Airports Without Operating Control Towers or AC 90-42C.)

Aviation weather briefing service is provided by FSS specialists. Flight and weather briefing services are also available by calling the telephone numbers listed.

Remote Communications Outlet (RCO)—An unmanned air/ground communications facility that is remotely controlled and provides UHF or VHF communications capability to extend the service range of an FSS.

Civil Communications Frequencies—Civil communications frequencies used in the FSS air/ground system are operated on 122.0, 122.2, 123.6; emergency 121.5; plus receive-only on 122.1.

- 122.0 is assigned as the Enroute Flight Advisory Service frequency at selected FSS RADIO outlets.
- 122.2 is assigned as a common enroute frequency.
- 123.6 is assigned as the airport advisory frequency at select non-tower locations. At airports with a tower, FSS may provide airport advisories on the tower frequency when tower is closed.
- 122.1 is the primary receive-only frequency at VOR's.
- Some FSS's are assigned 50 kHz frequencies in the 122-126 MHz band (eg. 122.45). Pilots using the FSS A/G system should refer to this directory or appropriate charts to determine frequencies available at the FSS or remoted facility through which they wish to communicate.

Emergency frequency 121.5 and 243.0 are available at all Flight Service Stations, most Towers, Approach Control and RADAR facilities.

Frequencies published followed by the letter "T" or "R", indicate that the facility will only transmit or receive respectively on that frequency. All radio aids to navigation (NAVAID) frequencies are transmit only.

**TERMINAL SERVICES**

SFA—Single Frequency Approach.

CTAF—A program designed to get all vehicles and aircraft at airports without an operating control tower on a common frequency.

ATIS—A continuous broadcast of recorded non-control information in selected terminal areas.

D-ATIS—Digital ATIS provides ATIS information in text form outside the standard reception range of conventional ATIS via landline & data link communications and voice message within range of existing transmitters.

AUNICOM—Automated UNICOM is a computerized, command response system that provides automated weather, radio check capability and airport advisory information selected from an automated menu by microphone clicks.

UNICOM—A non-government air/ground radio communications facility which may provide airport information.

PTD—Pilot to Dispatcher.

APP CON—Approach Control. The symbol **Ⓡ** indicates radar approach control.

TOWER—Control tower.

GCA—Ground Control Approach System.

GND CON—Ground Control.

## AIRPORT/FACILITY DIRECTORY LEGEND

25

GCO—Ground Communication Outlet—An unstaffed, remotely controlled, ground/ground communications facility. Pilots at uncontrolled airports may contact ATC and FSS via VHF to a telephone connection to obtain an instrument clearance or close a VFR or IFR flight plan. They may also get an updated weather briefing prior to takeoff. Pilots will use four “key clicks” on the VHF radio to contact the appropriate ATC facility or six “key clicks” to contact the FSS. The GCO system is intended to be used only on the ground.

DEP CON—Departure Control. The symbol  $\text{\textcircled{R}}$  indicates radar departure control.

CLNC DEL—Clearance Delivery.

CPDLC—Controller Pilot Data Link Communication. FANS ATC data communication capability from the aircraft to the ATC Data Link system.

PRE TAXI CLNC—Pre taxi clearance.

VFR ADVSY SVC—VFR Advisory Service. Service provided by Non-Radar Approach Control. Advisory Service for VFR aircraft (upon a workload basis) ctc APP CON.

COMD POST—Command Post followed by the operator call sign in parenthesis.

PMSV—Pilot-to-Metro Service call sign, frequency and hours of operation, when full service is other than continuous. PMSV installations at which weather observation service is available shall be indicated, following the frequency and/or hours of operation as “Wx obsn svc 1900-0000Z+” or “other times” may be used when no specific time is given. PMSV facilities manned by forecasters are considered “Full Service”. PMSV facilities manned by weather observers are listed as “Limited Service”.

OPS—Operations followed by the operator call sign in parenthesis.

CON

RANGE

FLT FLW—Flight Following

MEDIVAC

NOTE: Communication frequencies followed by the letter “X” indicate frequency available on request.

### $\text{\textcircled{28}}$ AIRSPACE

Information concerning Class B, C, and part-time D and E surface area airspace shall be published with effective times, if available.

CLASS B—Radar Sequencing and Separation Service for all aircraft in CLASS B airspace.

CLASS C—Separation between IFR and VFR aircraft and sequencing of VFR arrivals to the primary airport.

TRSA—Radar Sequencing and Separation Service for participating VFR Aircraft within a Terminal Radar Service Area.

Class C, D, and E airspace described in this publication is that airspace usually consisting of a 5 NM radius core surface area that begins at the surface and extends upward to an altitude above the airport elevation (charted in MSL for Class C and Class D).

Class E surface airspace normally extends from the surface up to but not including the overlying controlled airspace.

When part-time Class C or Class D airspace defaults to Class E, the core surface area becomes Class E. This will be formatted as:  
**AIRSPACE: CLASS C** svc “times” ctc **APP CON** other times CLASS E:

or

**AIRSPACE: CLASS D** svc “times” other times CLASS E.

When a part-time Class C, Class D or Class E surface area defaults to Class G, the core surface area becomes Class G up to, but not including, the overlying controlled airspace. Normally, the overlying controlled airspace is Class E airspace beginning at either 700’ or 1200’ AGL and may be determined by consulting the relevant VFR Sectional or Terminal Area Charts. This will be formatted as:

**AIRSPACE: CLASS C** svc “times” ctc **APP CON** other times CLASS G, with CLASS E 700’ (or 1200’) AGL & abv:

or

**AIRSPACE: CLASS D** svc “times” other times CLASS G with CLASS E 700’ (or 1200’) AGL & abv:

or

**AIRSPACE: CLASS E** svc “times” other times CLASS G with CLASS E 700’ (or 1200’) AGL & abv.

**NOTE: AIRSPACE SVC “TIMES” INCLUDE ALL ASSOCIATED ARRIVAL EXTENSIONS.** Surface area arrival extensions for instrument approach procedures become part of the primary core surface area. These extensions may be either Class D or Class E airspace and are effective concurrent with the times of the primary core surface area. For example, when a part-time Class C, Class D or Class E surface area defaults to Class G, the associated arrival extensions will default to Class G at the same time. When a part-time Class C or Class D surface area defaults to Class E, the arrival extensions will remain in effect as Class E airspace.

**NOTE: CLASS E AIRSPACE EXTENDING UPWARD FROM 700 FEET OR MORE ABOVE THE SURFACE, DESIGNATED IN CONJUNCTION WITH AN AIRPORT WITH AN APPROVED INSTRUMENT PROCEDURE.**

Class E 700’ AGL (shown as magenta vignette on sectional charts) and 1200’ AGL (blue vignette) areas are designated when necessary to provide controlled airspace for transitioning to/from the terminal and enroute environments. Unless otherwise specified, these 700’/1200’ AGL Class E airspace areas remain in effect continuously, regardless of airport operating hours or surface area status. These transition areas should not be confused with surface areas or arrival extensions.

(See Chapter 3, AIRSPACE, in the Aeronautical Information Manual for further details)

26

**AIRPORT/FACILITY DIRECTORY LEGEND**

**29 VOR TEST FACILITY (VOT)**

The VOT transmits a signal which provides users a convenient means to determine the operational status and accuracy of an aircraft VOR receiver while on the ground. Ground based VOTs and the associated frequency shall be shown when available. VOTs are also shown with identifier, frequency and referenced remarks in the VOR Receiver Check section in the back of this publication.

**30 RADIO AIDS TO NAVIGATION**

The Airport/Facility Directory section of the Chart Supplement lists, by facility name, all Radio Aids to Navigation that appear on FAA, Aeronautical Information Services Visual or IFR Aeronautical Charts and those upon which the FAA has approved an Instrument Approach Procedure, with exception of selected TACANs. All VOR, VORTAC, TACAN and ILS equipment in the National Airspace System has an automatic monitoring and shutdown feature in the event of malfunction. Unmonitored, as used in this publication, for any navigational aid, means that monitoring personnel cannot observe the malfunction or shutdown signal. The NAVAID NOTAM file identifier will be shown as "NOTAM FILE IAD" and will be listed on the Radio Aids to Navigation line. When two or more NAVAIDS are listed and the NOTAM file identifier is different from that shown on the Radio Aids to Navigation line, it will be shown with the NAVAID listing. NOTAM file identifiers for ILSs and its components (e.g., NDB (LOM) are the same as the associated airports and are not repeated. Automated Surface Observing System (ASOS), Automated Weather Observing System (AWOS), and Hazardous Inflight Weather Advisory Service (HIWAS) will be shown when this service is broadcast over selected NAVAIDS.

NAVAID information is tabulated as indicated in the following sample:

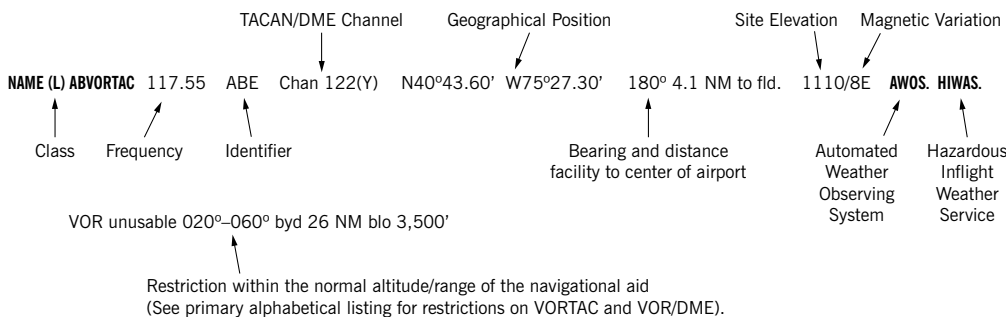

Note: Those DME channel numbers with a (Y) suffix require TACAN to be placed in the "Y" mode to receive distance information.

**HIWAS**—Hazardous Inflight Weather Advisory Service is a continuous broadcast of inflight weather advisories including summarized SIGMETs, convective SIGMETs, AIRMETS and urgent PIREPs. HIWAS is presently broadcast over selected VOR's throughout the U.S.

**ASR/PAR**—Indicates that Surveillance (ASR) or Precision (PAR) radar instrument approach minimums are published in the U.S. Terminal Procedures. Only part-time hours of operation will be shown.

## AIRPORT/FACILITY DIRECTORY LEGEND

27

## RADIO CLASS DESIGNATIONS

VOR/DME/TACAN Standard Service Volume (SSV) Classifications

<u>SSV Class</u>	<u>Altitudes</u>	<u>Distance (NM)</u>
(T) Terminal	1000' to 12,000'	25
(L) Low Altitude	1000' to 18,000'	40
(H) High Altitude	1000' to 14,500'	40
	14,500' to 18,000'	100
	18,000' to 45,000'	130
	45,000' to 60,000'	100

NOTE: Additionally, (H) facilities provide (L) and (T) service volume and (L) facilities provide (T) service. Altitudes are with respect to the station's site elevation. Coverage is not available in a cone of airspace directly above the facility.

The term VOR is, operationally, a general term covering the VHF omnidirectional bearing type of facility without regard to the fact that the power, the frequency protected service volume, the equipment configuration, and operational requirements may vary between facilities at different locations.

AB _____	Automatic Weather Broadcast.
DF _____	Direction Finding Service.
DME _____	UHF standard (TACAN compatible) distance measuring equipment.
DME(Y) _____	UHF standard (TACAN compatible) distance measuring equipment that require TACAN to be placed in the "Y" mode to receive DME.
GS _____	Glide slope.
H _____	Non-directional radio beacon (homing), power 50 watts to less than 2,000 watts (50 NM at all altitudes).
HH _____	Non-directional radio beacon (homing), power 2,000 watts or more (75 NM at all altitudes).
H-SAB _____	Non-directional radio beacons providing automatic transcribed weather service.
ILS _____	Instrument Landing System (voice, where available, on localizer channel).
IM _____	Inner marker.
LDA _____	Localizer Directional Aid.
LMM _____	Compass locator station when installed at middle marker site (15 NM at all altitudes).
LOM _____	Compass locator station when installed at outer marker site (15 NM at all altitudes).
MH _____	Non-directional radio beacon (homing) power less than 50 watts (25 NM at all altitudes).
MM _____	Middle marker.
OM _____	Outer marker.
S _____	Simultaneous range homing signal and/or voice.
SABH _____	Non-directional radio beacon not authorized for IFR or ATC. Provides automatic weather broadcasts.
SDF _____	Simplified Direction Facility.
TACAN _____	UHF navigational facility—omnidirectional course and distance information.
VOR _____	VHF navigational facility—omnidirectional course only.
VOR/DME _____	Collocated VOR navigational facility and UHF standard distance measuring equipment.
VORTAC _____	Collocated VOR and TACAN navigational facilities.
W _____	Without voice on radio facility frequency.
Z _____	VHF station location marker at a LF radio facility.

**AIRPORT/FACILITY DIRECTORY LEGEND**  
**ILS FACILITY PERFORMANCE CLASSIFICATION CODES**

Codes define the ability of an ILS to support autoland operations. The two portions of the code represent Official Category and farthest point along a Category I, II, or III approach that the Localizer meets Category III structure tolerances.

Official Category: I, II, or III; the lowest minima on published or unpublished procedures supported by the ILS.

Farthest point of satisfactory Category III Localizer performance for Category I, II, or III approaches: A – 4 NM prior to runway threshold, B – 3500 ft prior to runway threshold, C – glide angle dependent but generally 750–1000 ft prior to threshold, T – runway threshold, D – 3000 ft after runway threshold, and E – 2000 ft prior to stop end of runway.

ILS information is tabulated as indicated in the following sample:

ILS/DME 108.5 I-ORL Chan 22 Rwy 18. Class IIE. LOM HERNY NDB.

ILS Facility Performance  
 Classification Code

**FREQUENCY PAIRING TABLE**

VHF FREQUENCY	TACAN CHANNEL	VHF FREQUENCY	TACAN CHANNEL	VHF FREQUENCY	TACAN CHANNEL	VHF FREQUENCY	TACAN CHANNEL
108.10	18X	108.55	22Y	111.05	47Y	114.85	95Y
108.30	20X	108.65	23Y	111.15	48Y	114.95	96Y
108.50	22X	108.75	24Y	111.25	49Y	115.05	97Y
108.70	24X	108.85	25Y	111.35	50Y	115.15	98Y
108.90	26X	108.95	26Y	111.45	51Y	115.25	99Y
109.10	28X	109.05	27Y	111.55	52Y	115.35	100Y
109.30	30X	109.15	28Y	111.65	53Y	115.45	101Y
109.50	32X	109.25	29Y	111.75	54Y	115.55	102Y
109.70	34X	109.35	30Y	111.85	55Y	115.65	103Y
109.90	36X	109.45	31Y	111.95	56Y	115.75	104Y
110.10	38X	109.55	32Y	113.35	80Y	115.85	105Y
110.30	40X	109.65	33Y	113.45	81Y	115.95	106Y
110.50	42X	109.75	34Y	113.55	82Y	116.05	107Y
110.70	44X	109.85	35Y	113.65	83Y	116.15	108Y
110.90	46X	109.95	36Y	113.75	84Y	116.25	109Y
111.10	48X	110.05	37Y	113.85	85Y	116.35	110Y
111.30	50X	110.15	38Y	113.95	86Y	116.45	111Y
111.50	52X	110.25	39Y	114.05	87Y	116.55	112Y
111.70	54X	110.35	40Y	114.15	88Y	116.65	113Y
111.90	56X	110.45	41Y	114.25	89Y	116.75	114Y
108.05	17Y	110.55	42Y	114.35	90Y	116.85	115Y
108.15	18Y	110.65	43Y	114.45	91Y	116.95	116Y
108.25	19Y	110.75	44Y	114.55	92Y	117.05	117Y
108.35	20Y	110.85	45Y	114.65	93Y	117.15	118Y
108.45	21Y	110.95	46Y	114.75	94Y	117.25	119Y

**FREQUENCY PAIRING TABLE**

The following is a list of paired VOR/ILS VHF frequencies with TACAN channels.

TACAN CHANNEL	VHF FREQUENCY	TACAN CHANNEL	VHF FREQUENCY	TACAN CHANNEL	VHF FREQUENCY	TACAN CHANNEL	VHF FREQUENCY
2X	134.5	25X	108.80	36X	109.90	47X	111.00
2Y	134.55	25Y	108.85	36Y	109.95	47Y	111.05
11X	135.4	26X	108.90	37X	110.00	48X	111.10
11Y	135.45	26Y	108.95	37Y	110.05	48Y	111.15
12X	135.5	27X	109.00	38X	110.10	49X	111.20
12Y	135.55	27Y	109.05	38Y	110.15	49Y	111.25
17X	108.00	28X	109.10	39X	110.20	50X	111.30
17Y	108.05	28Y	109.15	39Y	110.25	50Y	111.35
18X	108.10	29X	109.20	40X	110.30	51X	111.40
18Y	108.15	29Y	109.25	40Y	110.35	51Y	111.45
19X	108.20	30X	109.30	41X	110.40	52X	111.50
19Y	108.25	30Y	109.35	41Y	110.45	52Y	111.55
20X	108.30	31X	109.40	42X	110.50	53X	111.60
20Y	108.35	31Y	109.45	42Y	110.55	53Y	111.65
21X	108.40	32X	109.50	43X	110.60	54X	111.70
21Y	108.45	32Y	109.55	43Y	110.65	54Y	111.75
22X	108.50	33X	109.60	44X	110.70	55X	111.80
22Y	108.55	33Y	109.65	44Y	110.75	55Y	111.85
23X	108.60	34X	109.70	45X	110.80	56X	111.90
23Y	108.65	34Y	109.75	45Y	110.85	56Y	111.95
24X	108.70	35X	109.80	46X	110.90	57X	112.00
24Y	108.75	35Y	109.85	46Y	110.95	57Y	112.05

## AIRPORT/FACILITY DIRECTORY LEGEND

29

TACAN CHANNEL	VHF FREQUENCY	TACAN CHANNEL	VHF FREQUENCY	TACAN CHANNEL	VHF FREQUENCY	TACAN CHANNEL	VHF FREQUENCY
58X	112.10	77X	113.00	96X	114.90	115X	116.80
58Y	112.15	77Y	113.05	96Y	114.95	115Y	116.85
59X	112.20	78X	113.10	97X	115.00	116X	116.90
59Y	112.25	78Y	113.15	97Y	115.05	116Y	116.95
60X	133.30	79X	113.20	98X	115.10	117X	117.00
60Y	133.35	79Y	113.25	98Y	115.15	117Y	117.05
61X	133.40	80X	113.30	99X	115.20	118X	117.10
61Y	133.45	80Y	113.35	99Y	115.25	118Y	117.15
62X	133.50	81X	113.40	100X	115.30	119X	117.20
62Y	133.55	81Y	113.45	100Y	115.35	119Y	117.25
63X	133.60	82X	113.50	101X	115.40	120X	117.30
63Y	133.65	82Y	113.55	101Y	115.45	120Y	117.35
64X	133.70	83X	113.60	102X	115.50	121X	117.40
64Y	133.75	83Y	113.65	102Y	115.55	121Y	117.45
65X	133.80	84X	113.70	103X	115.60	122X	117.50
65Y	133.85	84Y	113.75	103Y	115.65	122Y	117.55
66X	133.90	85X	113.80	104X	115.70	123X	117.60
66Y	133.95	85Y	113.85	104Y	115.75	123Y	117.65
67X	134.00	86X	113.90	105X	115.80	124X	117.70
67Y	134.05	86Y	113.95	105Y	115.85	124Y	117.75
68X	134.10	87X	114.00	106X	115.90	125X	117.80
68Y	134.15	87Y	114.05	106Y	115.95	125Y	117.85
69X	134.20	88X	114.10	107X	116.00	126X	117.90
69Y	134.25	88Y	114.15	107Y	116.05	126Y	117.95
70X	112.30	89X	114.20	108X	116.10		
70Y	112.35	89Y	114.25	108Y	116.15		
71X	112.40	90X	114.30	109X	116.20		
71Y	112.45	90Y	114.35	109Y	116.25		
72X	112.50	91X	114.40	110X	116.30		
72Y	112.55	91Y	114.45	110Y	116.35		
73X	112.60	92X	114.50	111X	116.40		
73Y	112.65	92Y	114.55	111Y	116.45		
74X	112.70	93X	114.60	112X	116.50		
74Y	112.75	93Y	114.65	112Y	116.55		
75X	112.80	94X	114.70	113X	116.60		
75Y	112.85	94Y	114.75	113Y	116.65		
76X	112.90	95X	114.80	114X	116.70		
76Y	112.95	95Y	114.85	114Y	116.75		

③1 **COMM/NAV/WEATHER REMARKS:** These remarks consist of pertinent information affecting the current status of communications, NAVAIDS and weather.

Appendix 1

12320

TERMS/LANDING MINIMA DATA

IFR LANDING MINIMA

The United States Standard for Terminal Instrument Procedures (TERPS) is the approved criteria for formulating instrument approach procedures. Landing minima are established for six aircraft approach categories (ABCDE and COPTER). In the absence of COPTER MINIMA, helicopters may use the CAT A minima of other procedures.

LANDING MINIMA FORMAT

In this example airport elevation is 1179, and runway touchdown zone elevation is 1152.

	DA	Visibility (RVR 100's of feet)	Aircraft Approach Category HAT/HATH	
Category	A	B	C	D
S-ILS 27	1352/24		200	(200-½)
S-LOC 27	1440/24	288	(300-½)	1440/50 288 (300-1)
CIRCLING	1540-1 361 (400-1)	1640-1 461 (500-1)	1640-1½ 461 (500-1½)	1740-2 561 (600-2)
	MDA	HAA	Visibility in Statute Miles	

Straight-in ILS to Runway 27  
 Straight-in with Glide Slope Inoperative or not used to Runway 27  
 All weather minima in parentheses not applicable to Civil Pilots.  
 Military Pilots refer to appropriate regulations.

COPTER MINIMA ONLY

CATEGORY	COPTER
H-176°	680-½ 363 (400-½)

Copter Approach Direction  
 Height of MDA/DA Above Landing Area (HAL)  
 No circling minima are provided

RNAV (GPS) MINIMA EXAMPLE

CATEGORY	A	B	C	D
LPV DA	1540/24 258 (300-½)			
LNAV/VNAV DA	1600/24	318 (400-½)	1600/40 318 (400-¾)	
LNAV MDA	1840/24	558 (600-½)	1840/50 558 (600-1)	1840/60 558 (600-1¼)
CIRCLING	1840-1	545 (600-1)	1840-1½ 545 (600-1½)	1860-2 565 (600-2)

NOTE: The **W** symbol indicates outages of the WAAS vertical guidance may occur daily at this location due to initial system limitations. WAAS NOTAMS for vertical outages are not provided for this approach. Use LNAV minima for flight planning at these locations, whether as a destination or alternate. For flight operations at these locations, when the WAAS avionics indicate that LNAV/VNAV or LPV service is available, then vertical guidance may be used to complete the approach using the displayed level of service. Should an outage occur during the procedure, reversion to LNAV minima may be required. As the WAAS coverage is expanded, the **W** will be removed.

RNAV minima are dependent on navigation equipment capability, as stated in the applicable AFM, AFMS, or other FAA approved document. See AIM paragraph 5-4-5, AC 90-105 and AC 90-107 for detailed requirements for each line of minima.

AIRCRAFT APPROACH CATEGORIES

Aircraft approach category indicates a grouping of aircraft based on a speed of VREF, if specified, or if VREF not specified, 1.3 VSO at the maximum certificated landing weight. VREF, VSO, and the maximum certificated landing weight are those values as established for the aircraft by the certification authority of the country of registry. Helicopters are Category A aircraft. An aircraft shall fit in only one category. However, if it is necessary to operate at a speed in excess of the upper limit of the speed range for an aircraft's category, the minima for the category for that speed shall be used. For example, an airplane which fits into Category B, but is circling to land at a speed of 145 knots, shall use the approach Category D minima. As an additional example, a Category A airplane (or helicopter) which is operating at 130 knots on a straight-in approach shall use the approach Category C minima. See following category limits:

MANEUVERING TABLE

Approach Category	A	B	C	D	E
Speed (Knots)	0-90	91-120	121-140	141-165	Abv 165

TERMS/LANDING MINIMA DATA

LEGEND 20.—Instrument Approach Procedures Explanation of Terms.



13122

## TERMS/LANDING MINIMA DATA

### CIRCLING APPROACH OBSTACLE PROTECTED AIRSPACE

The circling MDA provides vertical clearance from obstacles when conducting a circle-to-land maneuver within the obstacle protected area. Circling approach obstacle protected areas extend laterally and longitudinally from the centerlines and ends of all runways at an airport by the distances shown in the following tables. The areas are technically defined by the tangential connection of arcs drawn at the radius distance shown from each runway end.

#### STANDARD CIRCLING APPROACH MANEUVERING RADIUS

Circling approach protected areas developed prior to late 2012 used the radius distances shown in the following table, expressed in nautical miles (NM), dependent on aircraft approach category. The approaches using standard circling approach areas can be identified by the absence of the **C** symbol on the circling line of minima.

Circling MDA in feet MSL	Approach Category and Circling Radius (NM)				
	CAT A	CAT B	CAT C	CAT D	CAT E
All Altitudes	1.3	1.5	1.7	2.3	4.5

#### **C** EXPANDED CIRCLING APPROACH MANEUVERING AIRSPACE RADIUS

Circling approach protected areas developed after late 2012 use the radius distance shown in the following table, expressed in nautical miles (NM), dependent on aircraft approach category, and the altitude of the circling MDA, which accounts for true airspeed increase with altitude. The approaches using expanded circling approach areas can be identified by the presence of the **C** symbol on the circling line of minima.

Circling MDA in feet MSL	Approach Category and Circling Radius (NM)				
	CAT A	CAT B	CAT C	CAT D	CAT E
1000 or less	1.3	1.7	2.7	3.6	4.5
1001-3000	1.3	1.8	2.8	3.7	4.6
3001-5000	1.3	1.8	2.9	3.8	4.8
5001-7000	1.3	1.9	3.0	4.0	5.0
7001-9000	1.4	2.0	3.2	4.2	5.3
9001 and above	1.4	2.1	3.3	4.4	5.5

#### Comparable Values of RVR and Visibility

The following table shall be used for converting RVR to ground or flight visibility. For converting RVR values that fall between listed values, use the next higher RVR value; do not interpolate. For example, when converting 1800 RVR, use 2400 RVR with the resultant visibility of ½ mile.

RVR (feet)	Visibility (statute miles)	RVR (feet)	Visibility (statute miles)
1600	¼	4500	⅞
2400	½	5000	1
3200	⅝	6000	1¼
4000	¾		

### RADAR MINIMA

	RWY	GS/TCH/RPI	CAT	DA/MDA-VIS	HAT/HATH/HAA	CEIL-VIS	CAT	DA/MDA-VIS	HAT/HATH/HAA	CEIL-VIS
PAR	10	2.5°/42/1000	ABCDE	195/16	100	(100-¼)				
	28	2.5°/48/1068	ABCDE	187/16	100	(100-¼)				
ASR	10		ABC	560/40	463	(500-¾)	DE	560/50	463	(500-1)
	28		AB	600/50	513	(600-1)	CDE	600/60	513	(600-1¼)
CIR	10		AB	560-1¼	463	(500-1¼)	CDE	560-1½	463	(500-1½)
	28		AB	600-1¼	503	(600-1¼)	CDE	600-1½	503	(600-1½)

Visibility in Statute Miles

All minimums in parentheses not applicable to Civil Pilots. Military Pilots refer to appropriate regulations.

Radar Minima:

1. Minima shown are the lowest permitted by established criteria. Pilots should consult applicable directives for their category of aircraft.
2. The circling MDA and weather minima to be used are those for the runway to which the final approach is flown- not the landing runway. In the above RADAR MINIMA example, a category C aircraft flying a radar approach to runway 10, circling to land on runway 28, must use an MDA of 560 feet with weather minima of 500-1½.

NOTE: Military RADAR MINIMA may be shown with communications symbology that indicates emergency frequency monitoring capability by the radar facility as follows:

(E) VHF and UHF emergency frequencies monitored

(V) VHF emergency frequency (121.5) monitored

(U) UHF emergency frequency (243.0) monitored

Additionally, unmonitored frequencies which are available on request from the controlling agency may be annotated with an "x".

▲ Alternate Minimums not standard. Civil users refer to tabulation. USA/USN/USAF pilots refer to appropriate regulations.

▲ NA Alternate minimums are Not Authorized due to unmonitored facility or absence of weather reporting service.

▼ Takeoff Minimums not standard and/or Departure Procedures are published. Refer to tabulation.

## TERMS/LANDING MINIMA DATA

LEGEND 21.—Instrument Approach Procedures Explanation of Terms.

## GENERAL INFO

## GENERAL INFORMATION

This publication is issued every 56 days and includes Standard Instrument Approach Procedures (SIAPS), Standard Instrument Departures (SIDs), Standard Terminal Arrivals (STARs), IFR Takeoff Minimums and (Obstacle) Departure Procedures (ODPs), IFR Alternate Minimums, and Radar Instrument Approach Minimums for use by civil and military aviation. The organization responsible for SIAPs, Radar Minimums, SIDs, STARs and graphic ODPs is identified in parentheses in the top margin of the procedure; e.g., (FAA), (FAA-O), (USA), (USAF), (USN). SIAPS with the (FAA) and (FAA-O) designation are regulated under 14 CFR, Part 97. SIAPs with the (FAA-O) designation have been developed under Other Transaction Agreement (OTA) by private providers and have been certified by the FAA. See 14 CFR, Part 91.175 (a) and the AIM for further details. 14 CFR, Part 91.175 (g) and the Special Notices section of the Airport/Facility Directory contains information on civil operations at military airports.

STANDARD TERMINAL ARRIVALS AND DEPARTURE PROCEDURES

The use of the associated codified STAR/DP and transition identifiers are requested of users when filing flight plans via teletype and are required for users filing flight plans via computer interface. It must be noted that when filing a STAR/DP with a transition, the first three coded characters of the STAR and the last three coded characters of the DP are replaced by the transition code. Examples: ACTON SIX ARRIVAL, file (AQN.AQN6); ACTON SIX ARRIVAL, EDNAS TRANSITION, file (EDNAS.AQN6). FREEHOLD THREE DEPARTURE, file (FREQ3.RBV), FREEHOLD THREE DEPARTURE, ELWOOD CITY TRANSITION, file (FREQ3.EWC).

**RNAV DP and STAR.** Effective March 15, 2007, these procedures, formerly identified as Type-A and Type-B, will be designated as RNAV 1 in accordance with amended Advisory Circular (AC) and ICAO terminology.

Refer to AC 90-100A U.S. TERMINAL AND EN ROUTE AREA NAVIGATION (RNAV) OPERATIONS and the Aeronautical Information Manual for additional guidance regarding these procedures.

**Standard RNAV 1 Procedure Chart Notes**

NOTE: RNAV 1

NOTE: DME/DME/IRU or GPS required

Some procedures may require use of GPS and will be identified by a "GPS required" note.

**RNAV 1 Procedure Characteristics and Operations**

1. Require use of an RNAV system with DME/DME/IRU, and/or GPS inputs.
2. Require use of a CDI, flight director, and/or autopilot, in lateral navigation mode, for flight guidance while operating on RNAV paths (track, course, or direct leg). Other methods providing an equivalent level of performance may be acceptable.
3. RNAV paths may start as low as 500 feet above airport elevation.

## GENERAL INFO

14149

## GENERAL INFO

## ABBREVIATIONS

AAUP.....	Attention All Users Page	HAA.....	Height above Airport
ADF.....	Automatic Direction Finder	HAL.....	Height above Landing
AFIS.....	Automatic Flight Information Service	HAT.....	Height above Touchdown
ALS.....	Approach Light System	HATH.....	Height Above Threshold
ALSF.....	Approach Light System with Sequenced Flashing Lights	HGS.....	Head-up Guidance System
AP.....	Autopilot System	HIRL.....	High Intensity Runway Lights
APCH.....	Approach	HUD.....	Head-up Display
APP CON.....	Approach Control	IAF.....	Initial Approach Fix
ARR.....	Arrival	ICAO.....	International Civil Aviation Organization
ASOS.....	Automated Surface Observing System	IF.....	Intermediate Fix
ASR/PAR.....	Published Radar Minimums at this Airport	IM.....	Inner Marker
ATIS.....	Automatic Terminal Information Service	INT.....	Intersection
AUNICOM.....	Automated UNICOM	LAAS.....	Local Area Augmentation System
AWOS.....	Automated Weather Observing System	LDA.....	Localizer Type Directional Aid
AZ.....	Azimuth	Ldg.....	Landing
BC.....	Back Course	LRL.....	Low Intensity Runway Lights
BND.....	Bound	LNAV.....	Lateral Navigation
C.....	Circling	LOC.....	Localizer
CAT.....	Category	LP.....	Localizer Performance
CCW.....	Counter Clockwise	LPV.....	Localizer Performance with Vertical Guidance
CDI.....	Course Deviation Indicator	LR.....	Lead Radial. Provides at least 2 NM (Copter 1 NM) of lead to assist in turning onto the intermediate/final course.
Chan.....	Channel	MAA.....	Maximum Authorized Altitude
CIR.....	Circling	MALS.....	Medium Intensity Approach Light System
CLNC DEL.....	Clearance Delivery	MALSR.....	Medium Intensity Approach Light System with RAIL
CNF.....	Computer Navigation Fix	MAP.....	Missed Approach Point
CTAF.....	Common Traffic Advisory Frequency	MDA.....	Minimum Descent Altitude
CW.....	Clockwise	MIRL.....	Medium Intensity Runway Lights
DA.....	Decision Altitude	MLS.....	Microwave Landing System
DER.....	Departure End of Runway	MM.....	Middle Marker
DH.....	Decision Height	MRA.....	Minimum Reception Altitude
DME.....	Distance Measuring Equipment	N/A.....	Not Applicable
DTHR.....	Displaced Threshold	NA.....	Not Authorized
ELEV.....	Elevation	NDB.....	Non-directional Radio Beacon
EMAS.....	Engineered Material Arresting System	NFD.....	National Flight Database
FAF.....	Final Approach Fix	NM.....	Nautical Mile
FD.....	Flight Director System	NoPT.....	No Procedure Turn Required (Procedure Turn shall not be executed without ATC clearance)
FM.....	Fan Marker	ODALS.....	Omnidirectional Approach Light System
FMS.....	Flight Management System	ODP.....	Obstacle Departure Procedure
GCO.....	Ground Communications Outlet	OM.....	Outer Marker
GLS.....	Ground Based Augmentation System Landing System	PRM.....	Precision Runway Monitor
GPI.....	Ground Point of Interception		
GPS.....	Global Positioning System		
GS.....	Glide Slope		

## GENERAL INFO

14149

LEGEND 23.—Abbreviations.

## Appendix 1

14149

### GENERAL INFO

### ABBREVIATIONS

R.....	Radial
RA.....	Radio Altimeter setting height
RAIL.....	Runway Alignment Indicator Lights
RCLS.....	Runway Centerline Light System
REIL.....	Runway End Identifier Lights
RF.....	Radius-to-Fix
RLLS.....	Runway Lead-in Light System
RNAV.....	Area Navigation
RNP.....	Required Navigation Performance
RPI.....	Runway Point of Intercept(ion)
RRL.....	Runway Remaining Lights
Rwy.....	Runway
RVR.....	Runway Visual Range
S.....	Straight-in
SALS.....	Short Approach Light System
SSALR.....	Simplified Short Approach Light System with RAIL
SDF.....	Simplified Directional Facility
SM.....	Statute Mile
SOIA.....	Simultaneous Offset Instrument Approach
TAA.....	Terminal Arrival Area
TAC.....	TACAN
TCH.....	Threshold Crossing Height (height in feet Above Ground level)
TDZ.....	Touchdown Zone
TDZE.....	Touchdown Zone Elevation
TDZ/CL.....	Touchdown Zone and Runway Centerline Lighting
TDZL.....	Touchdown Zone Lights
THR.....	Threshold
THRE.....	Threshold Elevation
TODA.....	Takeoff Distance Available
TORA.....	Takeoff Run Available
TR.....	Track
VASI.....	Visual Approach Slope Indicator
VCOA.....	Visual Climb Over Airport
VDP.....	Visual Descent Point
VGSI.....	Visual Glide Slope Indicator
VNAV.....	Vertical Navigation
WAAS.....	Wide Area Augmentation System
WP/WPT.....	Waypoint (RNAV)

### GENERAL INFO

14149

LEGEND 23A.—Abbreviations.

LEGEND

INSTRUMENT APPROACH PROCEDURES (CHARTS)

**PLANVIEW SYMBOLS**

**TERMINAL ROUTES**

**HOLDING PATTERNS**

Holding pattern with max. restricted airspeed:  
 (175K) applies to all altitudes.  
 (210K) applies to altitudes above 6000' and including 14000'.  
 Arrival Holding Pattern altitude restrictions will be indicated when they deviate from the adjacent leg.  
 Limits will only be specified when they deviate from the standard. DME fixes may be shown.

**FIXES/ATC REPORTING REQUIREMENTS**

Reporting Point  
 ▲ Name (Compulsory)  
 △ Name (Non-Compulsory)

✕ Intersection

◆ WAYPOINT (Compulsory)    ✧ WAYPOINT (Non-Compulsory)

⊙ FLYOVER POINT    ⊕ MAP WP (Flyover)

Computer Navigation Fix (CNF)  
 x (NAME) ("x" omitted when it conflicts with runway pattern)

15 DME Distance From Facility    AUSTN INT ARC/DME/RNAV Fix

— R-198 — Radial line and value  
 — LR-198 — Lead Radial  
 — LB-198 — Lead Bearing

**ALTITUDES**

5500 Mandatory Altitude    3000 Recommended Altitude  
2500 Minimum Altitude    5000 Mandatory Block  
4300 Maximum Altitude    3000 Altitude

**INDICATED AIRSPEED**

<u>175K</u>	<u>120K</u>	<u>250K</u>	<u>180K</u>
Mandatory Airspeed	Minimum Airspeed	Maximum Airspeed	Recommended Airspeed

**RADIO AIDS TO NAVIGATION**

110.1 Underline indicates No Voice transmitted on this frequency

● VOR (Compulsory)	⬢ VORTAC (Compulsory)	⊙ NDB (Compulsory)
⬢ VOR/DME (Compulsory)	⬢ TACAN (Compulsory)	⊙ NDB/DME (Compulsory)
⬡ VOR (Non-Compulsory)	⬢ TACAN (Non-Compulsory)	⊙ NDB (Non-Compulsory)
⬢ VOR/DME (Non-Compulsory)	⬢ VORTAC (Non-Compulsory)	⊙ NDB/DME (Non-Compulsory)

◉ LOM/LMM (Compass locator at Outer Marker/Middle Marker)  
 ⬢ Marker Beacon  
 ⬢ Marker beacons that are not specifically part of the procedure but underlie the final approach course are shown in screened color.

▬ Localizer (LOC/LDA) Course  
 Right side shading- Front course; Left side shading- Back Course

▬ SDF Course

180°  
MLS Approach Azimuth

MICROWAVE  
 Chan 514  
 M-VZD  
 Glidepath 6.20°  
 DME 111.5 Chan 48(Y)

(Y) TACAN must be in "Y" mode to receive distance information.

SCOTT  
 Chan 59  
 SKE  
 (112.2)

VHF Paired Frequency

⊙ LOC/DME  
 ⊙ LOC/LDA/SDF/MLS Transmitter (shown when installation is offset from its normal position off the end of the runway.)

**Waypoint Data**

Coordinates	PRAYS		Waypoint Name
Frequency	N38° 58.30' W89° 51.50'	112.7 CAP 187.1°-56.2	
Identifier	590	Reference Facility Elevation	Radial-Distance (Facility to Waypoint)

**Primary Navaid with Coordinate Values**

LIMA  
 114.5 LIM  
 Chan 92  
 S12° 00.80'  
 W77° 07.00'

**Secondary Navaid**

LMM  
 LIMA  
 248 NT

LEGEND

LEGEND 24.—Instrument Approach Procedures (Symbols).

INSTRUMENT APPROACH PROCEDURES (CHARTS)

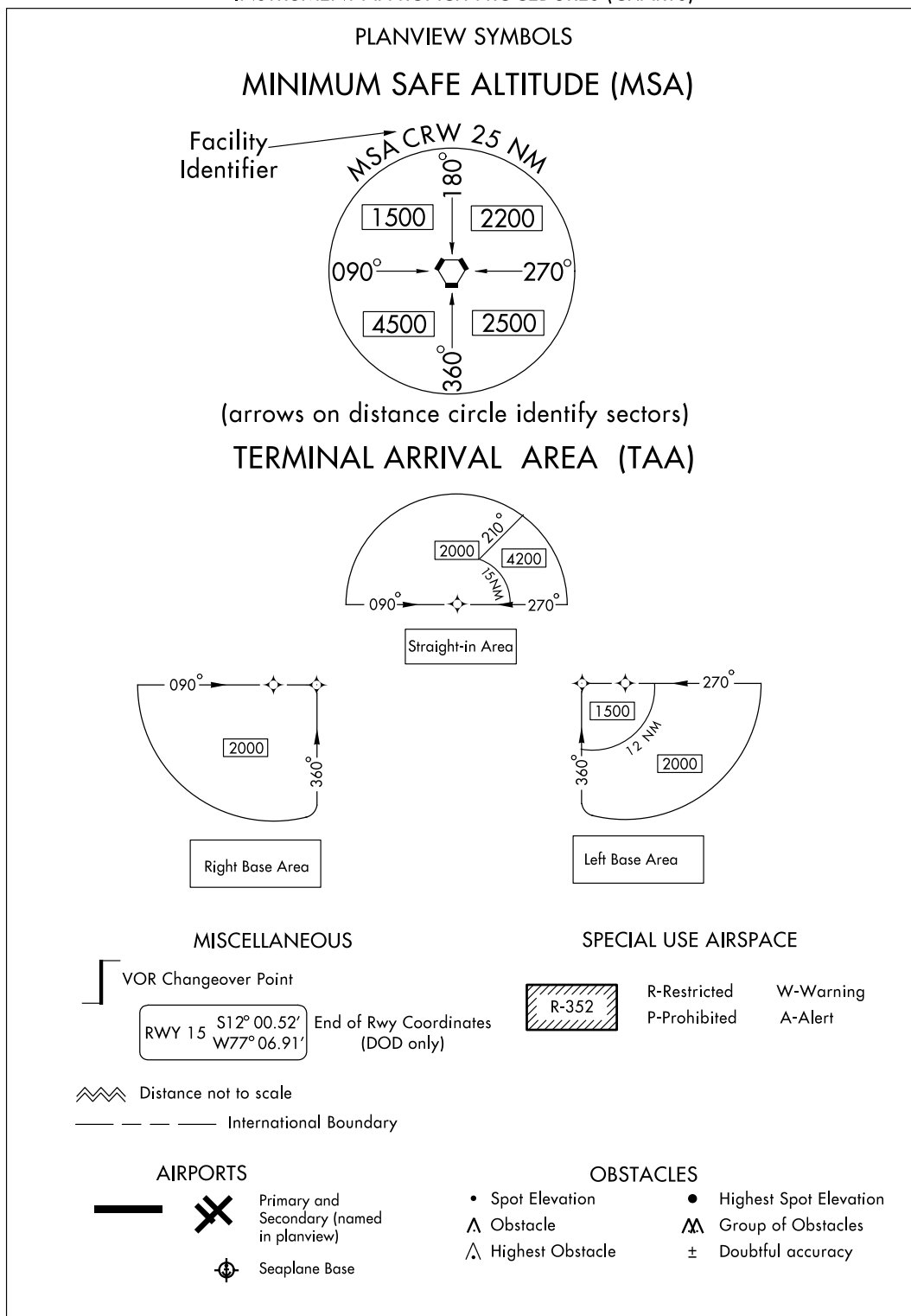

LEGEND

LEGEND 25.—Instrument Approach Procedures (Symbols).

13346

LEGEND

INSTRUMENT APPROACH PROCEDURES (CHARTS)

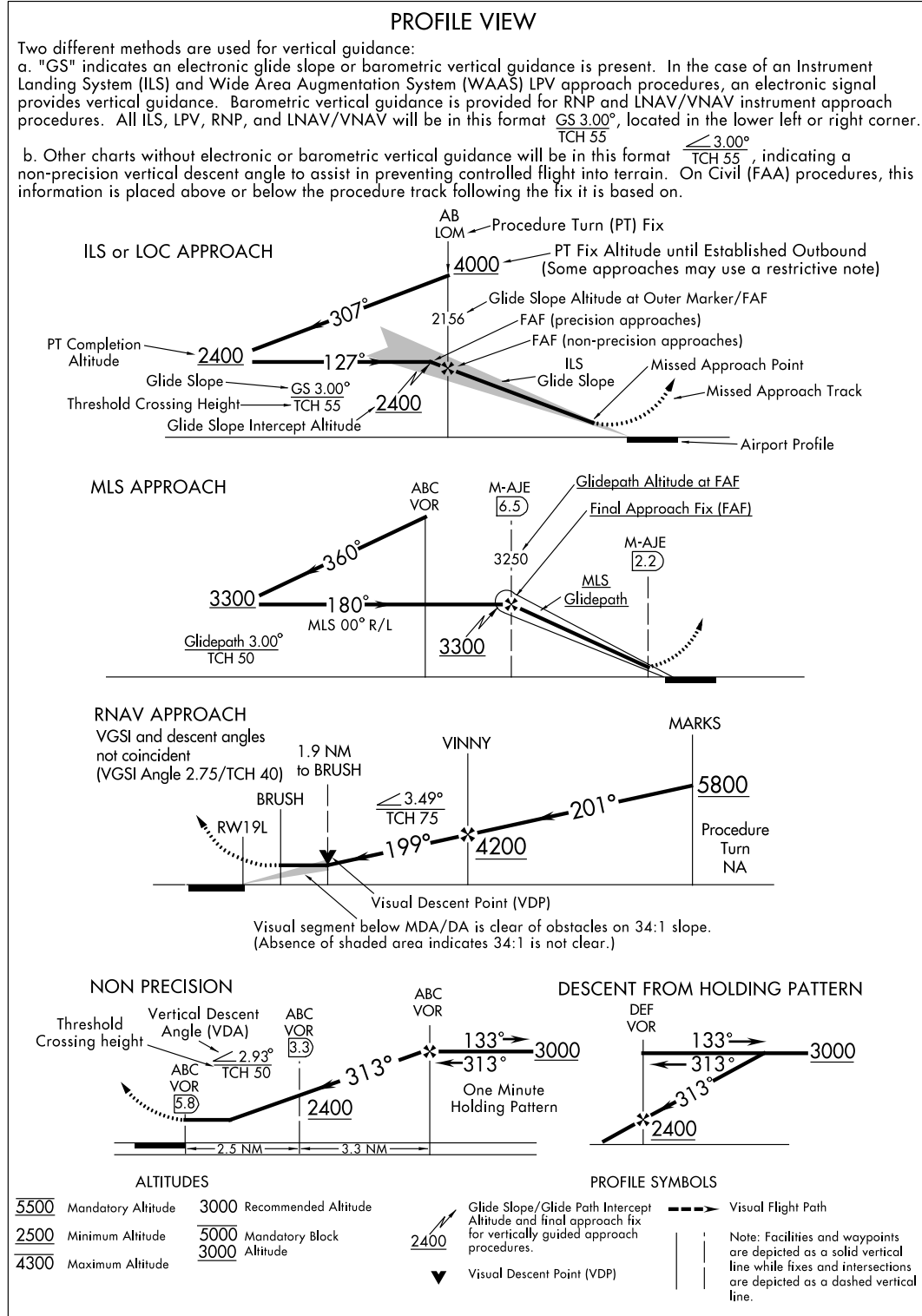

LEGEND

13346

LEGEND 26.—Instrument Approach Procedures (Profile).

Appendix 1

CLIMB/DESCENT TABLE 10042

INSTRUMENT TAKEOFF OR APPROACH PROCEDURE CHARTS RATE OF CLIMB/DESCENT TABLE (ft. per min)													
A rate of climb/descent table is provided for use in planning and executing climbs or descents under known or approximate ground speed conditions. It will be especially useful for approaches when the localizer only is used for course guidance. A best speed, power, altitude combination can be programmed which will result in a stable glide rate and altitude favorable for executing a landing if minimums exist upon breakout. Care should always be exercised so that minimum descent altitude and missed approach point are not exceeded.													
CLIMB/ DESCENT ANGLE (degrees and tenths)	ft/NM	GROUND SPEED (knots)											
		60	90	120	150	180	210	240	270	300	330	360	
2.0	210	210	320	425	530	635	743	850	955	1060	1165	1275	
2.5	265	265	400	530	665	795	930	1060	1195	1325	1460	1590	
V E R T I C A L  P A T H  A N G L E	2.7	287	287	430	574	717	860	1003	1147	1290	1433	1576	1720
	2.8	297	297	446	595	743	892	1041	1189	1338	1486	1635	1783
	2.9	308	308	462	616	770	924	1078	1232	1386	1539	1693	1847
	3.0	318	318	478	637	797	956	1115	1274	1433	1593	1752	1911
	3.1	329	329	494	659	823	988	1152	1317	1481	1646	1810	1975
	3.2	340	340	510	680	850	1020	1189	1359	1529	1699	1869	2039
	3.3	350	350	526	701	876	1052	1227	1402	1577	1752	1927	2103
	3.4	361	361	542	722	903	1083	1264	1444	1625	1805	1986	2166
3.5	370	370	555	745	930	1115	1300	1485	1670	1860	2045	2230	
4.0	425	425	640	850	1065	1275	1490	1700	1915	2125	2340	2550	
4.5	480	480	715	955	1195	1435	1675	1915	2150	2390	2630	2870	
5.0	530	530	795	1065	1330	1595	1860	2125	2390	2660	2925	3190	
5.5	585	585	880	1170	1465	1755	2050	2340	2635	2925	3220	3510	
6.0	640	640	960	1275	1595	1915	2235	2555	2875	3195	3510	3830	
6.5	690	690	1040	1385	1730	2075	2425	2770	3115	3460	3805	4155	
7.0	745	745	1120	1490	1865	2240	2610	2985	3355	3730	4105	4475	
7.5	800	800	1200	1600	2000	2400	2800	3200	3600	4000	4400	4800	
8.0	855	855	1280	1710	2135	2560	2990	3415	3845	4270	4695	5125	
8.5	910	910	1360	1815	2270	2725	3180	3630	4085	4540	4995	5450	
9.0	960	960	1445	1925	2405	2885	3370	3850	4330	4810	5295	5775	
9.5	1015	1015	1525	2035	2540	3050	3560	4065	4575	5085	5590	6100	
10.0	1070	1070	1605	2145	2680	3215	3750	4285	4820	5355	5890	6430	

CLIMB/DESCENT TABLE 10042

LEGEND 27.—Instrument Takeoff or Approach Procedure Charts, Rate-of-Climb/Descent Table.



12320

# LEGEND

## LEGEND

### STANDARD TERMINAL ARRIVAL (STAR) CHARTS DEPARTURE PROCEDURE (DP) CHARTS

Applies to both STAR and DP Charts unless otherwise noted.

#### RADIO AIDS TO NAVIGATION

VOR (Compulsory)	VORTAC (Compulsory)	NDB (Compulsory)
VOR/DME (Compulsory)	TACAN (Compulsory)	NDB/DME (Compulsory)
VOR (Non-Compulsory)	TACAN (Non-Compulsory)	
VOR/DME (Non-Compulsory)	NDB (Non-Compulsory)	
VORTAC (Non-Compulsory)	NDB/DME (Non-Compulsory)	

LMM, LOM (Compass locator)  
 Marker Beacon

LOC (shown when installation is offset from its normal position off the end of the runway.) (DP)  
 LOC/DME

Localizer Course  
 SDF Course

(T) indicates frequency protection range (STAR)  
 (Y) TACAN must be placed in "Y" mode to receive distance information

**ORLANDO**  
 Frequency: 112.25 (T) ORL  
 Chan 59 (Y)  
 N28°32.56' - W81°20.10'  
 L-19, H-5  
 Enroute Chart Reference

**PRAYS**  
 Frequency: 112.7 CAP  
 N38°58.30' W89°51.50'  
 187.1°-56.2  
 590  
 Reference Facility Elevation  
 Radial-Distance (Facility to Waypoint)

#### ROUTES

4500 MEA-Minimum Enroute Altitude  
 \*3500 MOCA-Minimum Obstruction Clearance Altitude  
 Departure Route - Arrival Route  
 (65) Mileage between Radio Aids, Reporting Points, and Route Breaks

Transition Route  
 R-275 Radial line and value  
 Lost Communications Track

V12 DP Holding Pattern  
 J80 STAR Holding Pattern

Holding pattern with max. restricted airspeed (175K) applies to all altitudes (210K) applies to altitudes above 6000' to and including 14000'

#### SPECIAL USE AIRSPACE

R-352 R-Restricted  
 W-Warning  
 P-Prohibited  
 A-Alert  
 MOA-Military Operations Area

#### ALTITUDES

5500 Mandatory Altitude (Cross at)  
2300 Minimum Altitude (Cross at or above)  
4800 Maximum Altitude (Cross at or below)

15000  
12000 Block Altitude

Altitude change at other than Radio Aids (STAR)

#### ATC CROSSING ALTITUDES (DP)

5500 (ATC) 2300 (ATC) 4800 (ATC)  
 4300 1700 3000  
 Minimum required altitude

#### INDICATED AIRSPEED

175K Mandatory Airspeed  
120K Minimum Airspeed  
250K Maximum Airspeed

#### AIRPORTS

(DP) Civil Military Civil-Military

#### MISCELLANEOUS

Changeover Point  
 Distance not to scale (DP)  
 International Boundary (DP)  
 Takeoff Minimums and (Obstacle) Departure Procedures entry published. (DP)

# LEGEND

LEGEND 28.—Standard Arrival/Departure Charts.

LEGEND

INSTRUMENT APPROACH PROCEDURES (CHARTS)

### AIRPORT DIAGRAM/AIRPORT SKETCH

**Runways**

Hard Surface	Other Than Hard Surface	Stopways, Taxiways, Parking Areas, Water Runways	Displaced Threshold
Closed Runway	Closed Taxiway	Under Construction	Metal Surface

ARRESTING GEAR: Specific arresting gear systems; e.g., BAK12, MA-1A etc., shown on airport diagrams, not applicable to Civil Pilots. Military Pilots refer to appropriate DOD publications.

uni-directional   
 bi-directional   
 Jet Barrier

**ARRESTING SYSTEM**

**REFERENCE FEATURES**

Buildings.....	
24-Hour Self-Serve Fuel ##.....	
Tanks.....	
Obstructions.....	
Airport Beacon #.....	
Runway	
Radar Reflectors.....	
Hot Spot .....	
Control Tower #.....	TWR

# When Control Tower and Rotating Beacon are co-located, Beacon symbol will be used and further identified as TWR.

## A fuel symbol is shown to indicate 24-hour self-serve fuel available, see appropriate A/FD, Alaska or Pacific Supplement for information.

Runway length depicted is the physical length of the runway (end-to-end, including displaced thresholds if any) but excluding areas designated as stopways.

A symbol is shown to indicate runway declared distance information available, see appropriate A/FD, Alaska or Pacific Supplement for distance information.

Runway Weight Bearing Capacity/or PCN Pavement Classification Number is shown as a codified expression. Refer to the appropriate Supplement/Directory for applicable codes e.g., RWY 14-32 PCN 80 F/D/X/U S-75, D-185, 2S-175, 2D-325

Helicopter Alighting Areas

Negative Symbols used to identify Copter Procedures landing point.....

Runway Threshold elevation.....THRE 123

Runway TDZ elevation.....TDZE 123

Runway Slope.....0.3% DOWN

Runway Slope.....0.8% UP

(shown when runway slope is greater than or equal to 0.3%)

NOTE:  
Runway Slope measured to midpoint on runways 8000 feet or longer.

U.S. Navy Optical Landing System (OLS) "OLS" location is shown because of its height of approximately 7 feet and proximity to edge of runway may create an obstruction for some types of aircraft.

Approach light symbols are shown in the Flight Information Handbook.

Airport diagram scales are variable.

True/magnetic North orientation may vary from diagram to diagram

Coordinate values are shown in 1 or 1/2 minute increments. They are further broken down into 6 second ticks, within each 1 minute increments.

Positional accuracy within ±600 feet unless otherwise noted on the chart.

NOTE:  
All new and revised airport diagrams are shown referenced to the World Geodetic System (WGS) (noted on appropriate diagram), and may not be compatible with local coordinates published in FLIP. (Foreign Only)

SCOPE

Airport diagrams are specifically designed to assist in the movement of ground traffic at locations with complex runway/taxiway configurations. Airport diagrams are not intended to be used for approach and landing or departure operations. For revisions to Airport Diagrams: Consult FAA Order 7910.4.

LEGEND

LEGEND 29.—Airport Diagram.

09239  
**LEGEND**

INSTRUMENT APPROACH PROCEDURES (CHARTS)  
APPROACH LIGHTING SYSTEM - UNITED STATES

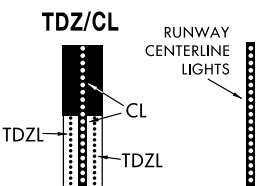
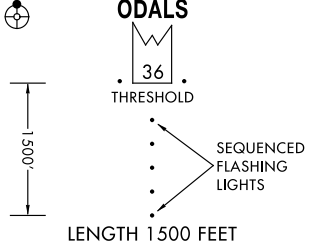
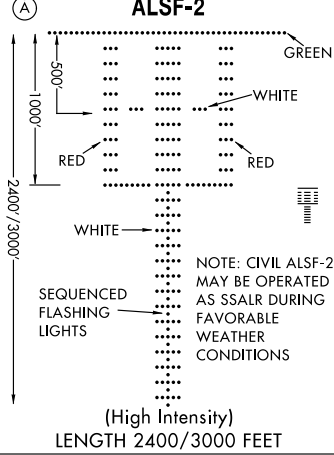
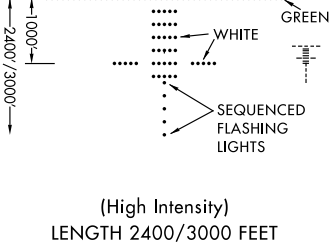
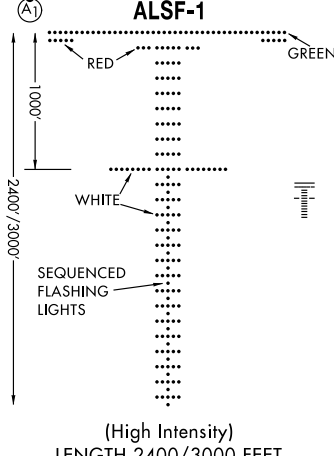
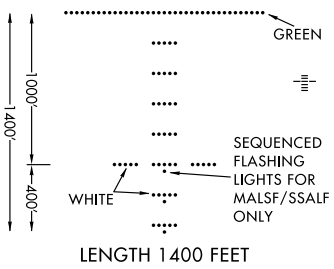
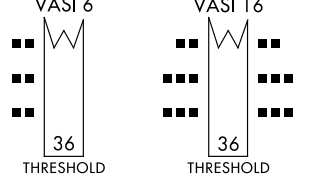
<p>Approach lighting and visual glide slope systems are indicated on the airport sketch by an identifier, e.g., (A<sub>2</sub>), (V), etc.</p> <p>A dot "•" portrayed with approach lighting letter identifier indicates sequenced flashing lights (F) installed with the approach lighting system e.g., (A<sub>1</sub>). Negative symbology, e.g., (A<sub>1</sub>), (V) indicates Pilot Controlled Lighting (PCL).</p>		
<p><b>RUNWAY TOUCHDOWN ZONE AND CENTERLINE LIGHTING SYSTEMS</b></p>  <p>TDZ/CL TDZL CL RUNWAY CENTERLINE LIGHTS</p> <p>AVAILABILITY of TDZ/CL will be shown by NOTE in SKETCH e.g. "TDZ/CL Rwy 15"</p>	<p><b>SHORT APPROACH LIGHTING SYSTEM</b></p> <p>(A<sub>2</sub>)</p> <p><b>SALS/SALSF</b> (High Intensity)</p> <p>SAME AS INNER 1500' OF ALSF-1</p>	<p><b>OMNIDIRECTIONAL APPROACH LIGHTING SYSTEM</b></p> <p>(A<sub>2</sub>)</p> <p><b>ODALS</b></p>  <p>THRESHOLD 1500' SEQUENCED FLASHING LIGHTS LENGTH 1500 FEET</p>
	<p><b>APPROACH LIGHTING SYSTEM</b></p> <p>(A<sub>1</sub>)</p> <p><b>ALSF-2</b></p>  <p>2400'/3000' 500' 1000' GREEN WHITE RED RED WHITE SEQUENCED FLASHING LIGHTS</p> <p>NOTE: CIVIL ALSF-2 MAY BE OPERATED AS SSALR DURING FAVORABLE WEATHER CONDITIONS</p> <p>(High Intensity) LENGTH 2400/3000 FEET</p>	<p><b>SIMPLIFIED SHORT APPROACH LIGHTING SYSTEM</b></p> <p>(A<sub>3</sub>)</p> <p><b>SSALR</b></p>  <p>1000' 2400'/3000' GREEN WHITE SEQUENCED FLASHING LIGHTS</p> <p>(High Intensity) LENGTH 2400/3000 FEET</p>
<p><b>APPROACH LIGHTING SYSTEM</b></p> <p>(A<sub>1</sub>)</p> <p><b>ALSF-1</b></p>  <p>1000' 2400'/3000' RED GREEN WHITE SEQUENCED FLASHING LIGHTS</p> <p>(High Intensity) LENGTH 2400/3000 FEET</p>	<p><b>MEDIUM INTENSITY (MALS and MALSF) OR SIMPLIFIED SHORT (SSALS and SSALF) APPROACH LIGHTING SYSTEMS</b></p> <p>(A<sub>4</sub>)</p>  <p>1000' 1400' 400' GREEN WHITE SEQUENCED FLASHING LIGHTS FOR MALSF/SSALF ONLY</p> <p>LENGTH 1400 FEET</p>	<p>(V<sub>3</sub>)</p> <p><b>VISUAL APPROACH SLOPE INDICATOR</b></p> <p><b>VASI</b></p> <p>VISUAL APPROACH SLOPE INDICATOR WITH A THRESHOLD CROSSING HEIGHT TO ACCOMMODATE LONG BODIED OR JUMBO AIRCRAFT.</p>  <p>VASI 6 36 THRESHOLD</p> <p>VASI 16 36 THRESHOLD</p>
	<p><b>MEDIUM INTENSITY APPROACH LIGHTING SYSTEM</b></p> <p>with Runway Alignment Indicator Lights</p> <p>(A<sub>5</sub>)</p> <p><b>MALSR</b></p> <p>SAME LIGHT CONFIGURATION AS SSALR.</p>	

**LEGEND**

LEGEND 30.—Approach Lighting Systems.

Appendix 1

04330

LEGEND

INSTRUMENT APPROACH PROCEDURES (CHARTS)  
APPROACH LIGHTING SYSTEM - UNITED STATES

Approach lighting and visual glide slope systems are indicated on the airport sketch by an identifier, (A2), (V) etc.

A dot "•" portrayed with approach lighting letter identifier indicates sequenced flashing lights (F) installed with the approach lighting system e.g., (A1). Negative symbology, e.g., (A1), (V) indicates Pilot Controlled Lighting (PCL).

(P) **PRECISION APPROACH PATH INDICATOR**  
**PAPI**

Too low      Slightly low

On correct approach path

Slightly high      Too high

Legend: □ White ■ Red

(V2) **PULSATING VISUAL APPROACH SLOPE INDICATOR**  
**PVASI**

Above Glide Path Pulsating White

On Glide Path Steady, White or Alternating Red/White

Below Glide Path Pulsating Red

Threshold

CAUTION: When viewing the pulsating visual approach slope indicators in the pulsating white or pulsating red sectors, it is possible to mistake this lighting aid for another aircraft or a ground vehicle. Pilots should exercise caution when using this type of system.

(V1) **"T"-VISUAL APPROACH SLOPE INDICATOR**  
**"T"-VASI**

"T" ON BOTH SIDES OF RWY  
ALL LIGHTS VARIABLE WHITE.  
CORRECT APPROACH SLOPE-  
ONLY CROSS BAR VISIBLE.  
UPRIGHT "T"- FLY UP.  
INVERTED "T"- FLY DOWN.  
RED "T"- GROSS  
UNDERSHOOT.

(V4) **TRI-COLOR VISUAL APPROACH SLOPE INDICATOR**  
**TRCV**

Above Glide Path Amber

On Glide Path Green

Below Glide Path Red

CAUTION: When the aircraft descends from green to red, the pilot may see a dark amber color during the transition from green to red.

(V5) **ALIGNMENT OF ELEMENTS SYSTEMS**  
**APAP**

Above glide path      On Glide Path      Below Glide Path

Painted panels which may be lighted at night.  
To use the system the pilot positions the aircraft  
so the elements are in alignment.

LEGEND

LEGEND 31.—Approach Lighting System.

13122

## INOP COMPONENTS

## INOPERATIVE COMPONENTS OR VISUAL AIDS TABLE

Landing minimums published on instrument approach procedure charts are based upon full operation of all components and visual aids associated with the particular instrument approach chart being used. Higher minimums are required with inoperative components or visual aids as indicated below. If more than one component is inoperative, each minimum is raised to the highest minimum required by any single component that is inoperative. ILS glide slope inoperative minimums are published on the instrument approach charts as localizer minimums. This table may be amended by notes on the approach chart. Such notes apply only to the particular approach category(ies) as stated. See legend page for description of components indicated below.

## (1) ILS, MLS, PAR and RNAV (LPV line of minima)

Inoperative Component or Aid	Approach Category	Increase Visibility
ALSF 1 & 2, MALSR, & SSALR	ABCD	¼ mile

## (2) ILS with visibility minimum of 1,800 RVR

ALSF 1 & 2, MALSR, & SSALR TDZL RCLS RVR	ABCD	To 4000 RVR
	ABCD	To 2400 RVR*
	ABCD	To ½ mile

\*1800 RVR authorized with the use of FD or AP or HUD to DA.

## (3) VOR, VOR/DME, TACAN, LOC, LOC/DME, LDA, LDA/DME, SDF, SDF/DME, GPS, ASR and RNAV (LNAV/VNAV, LP, LNAV lines of minima)

Inoperative Visual Aid	Approach Category	Increase Visibility
ALSF 1 & 2, MALSR, & SSALR	ABCD	½ mile
SSALS, MALS, & ODALS	ABC	¼ mile

## (4) NDB

ALSF 1 & 2, MALSR, & SSALR MALS, SSALS, ODALS	C	½ mile
	ABD	¼ mile
	ABC	¼ mile

## INOP COMPONENTS

LEGEND 32.—Inoperative Components or Visual Aids Table.

# IFR ENROUTE LOW ALTITUDE - U.S.

For use up to but not including 18,000' MSL  
HORIZONTAL DATUM: NORTH AMERICAN DATUM OF 1983

L E G E N D		
<b>AIRPORTS</b>		
<p>Facilities in BLUE or GREEN have an approved Instrument Approach Procedure and/or RADAR MINIMA published in either the FAA Terminal Procedures Publications or the DoD FIPs. Those in BLUE have an Instrument Approach Procedure and/or RADAR MINIMA published at least in the High Altitude DoD FIPs. Facilities in BROWN do not have a published Instrument Approach Procedure or RADAR MINIMA.</p>		
<p><b>LAND</b></p> <ul style="list-style-type: none"> <li> Civil</li> <li> Civil - Military</li> <li> Military</li> <li> Heliport</li> <li> SEA Civil</li> </ul>	<ol style="list-style-type: none"> <li>A solid line box enclosing the airport name indicates FAR 93 Special Requirements—see Directory/Supplement</li> <li>"NO SVFR" above the airport name indicates FAR 91 fixed-wing special VFR flight is prohibited</li> <li> or  following the airport name indicates Class C or Class D Airspace</li> </ol>	<ol style="list-style-type: none"> <li>Part-time or established by NOTAM. See Airport/Facility Directory for times of operation. In Alaska see Supplement Alaska</li> <li>Associated city names for public airports are shown above or preceding the airport name. If airport name and city name are the same, only the airport name is shown. City names for military and private airports are not shown. The airport identifier in parentheses follows the airport name.</li> </ol>
<p>                 Airport Ident ICAO Location Indicator shown outside contiguous U.S.                  Airport Elevation                  ATIS or AFIS (Alaska Only)                  Part-time                  Frequency                  Lighting Capability:                  1 Lighting available                  0 Pilot Controlled Lighting                  * Part-time or on request                  - No lighting available                  At private facilities - indicates no lighting information is available.             </p>		
<b>NAVAIDS</b>		
<p>VHF/UHF Data is depicted in BLACK LF/MF Data is depicted in BROWN</p> <p>COMPASS ROSE and/or NORTH ARROW Oriented to Magnetic North of NAVAID which may not be adjusted to the charted isogonic values.</p> <p>Smaller sizes are used in congested areas.</p> <p>Compass Locator Beacon</p>	VOR VOR/DME TACAN VORTAC LF/MF Non-directional Radiobeacon or Marine Radiobeacon LF/MF Non-directional Radiobeacon /DME	<p>Non Compulsory Reporting or Off Airway</p> <p>Compulsory Reporting</p> <p>ILS Localizer Course with additional navigation function</p>
<b>COMMUNICATION BOXES</b>		
<p><b>NAME (T)</b> 000.0 IDT 000(Y) ≡::</p> <p>VOR with TACAN compatible DME</p> <p>Underline indicates No Voice transmitted on this frequency. TACAN Channels are without voice but not underlined.</p> <p> Crosshatch indicates Shutdown status</p> <p>(T) Frequency protection usable range at 12,000' AGL - 25NM</p> <p>(Y) TACAN must be placed in "Y" mode to receive distance information</p> <p><b>NAME</b> 000 IDT ≡:: (000.0) N00°00.00' W000°00.00'</p> <p>TACAN Channel paired with VHF Frequency in parenthesis.</p> <p>Automated Weather Broadcast Systems:   ASOS/AWOS  HIWAS</p> <p>Automated weather, when available, is broadcast on the associated NAVAID frequency.</p> <p><b>NAME ASOS 000.0</b> Stand Alone ASOS/AWOS</p>	<p>000.0</p> <p><b>NAME</b> 000.0 IDT 000 ≡:: N00°00.00' W000°00.00'</p> <p><b>NAME</b> ← FSS name</p> <p>Freq(s) positioned above thin line NAVAID box is remoted to the NAVAID site. Other freq(s) at the named FSS radio are available, however, altitude and terrain may determine their reception.</p> <p>Thin line NAVAID boxes without freq(s) and FSS radio name indicates no freq(s) available.</p> <p>000.0 000.0</p> <p><b>NAME</b> 000.0 IDD 000 ≡:: N00°00.00' W000°00.00'</p> <p>Shadow NAVAID box indicates NAVAID and Flight Service Station (FSS) have same name</p> <p>000.0 000.0 FSS name and identifier not associated with NAVAID</p> <p><b>NAME IDT</b></p> <p>Remote Communications Outlet (RCO). FSS radio name and remoted freq(s) are shown.</p>	<p>Part-Time or On-Request</p> <p><b>NAME</b> * 000 IDT 00(000.0) ≡::</p> <p>LF/MF Non-directional Radiobeacon/DME VHF Freq paired with TACAN Channel</p> <p>SHADOW BOXES indicate Flight Service Stations (FSS). Frequencies 122.2, 255.4 and emergency 121.5 and 243.0 (Canada-121.5, 126.7 and 243.0) are available at many FSSs and are not shown. All other frequencies are shown. Certain FSSs provide Airport Advisory Service, see A/FD. Frequencies transmit and receive except those followed by R or T:                  R - Receive only                  T - Transmit only</p> <p>In Canada, a "D" after the frequency indicates a Dial-up Remote Communications Outlet.</p>

LEGEND 33.—IFR En Route Low Altitude (U.S.)

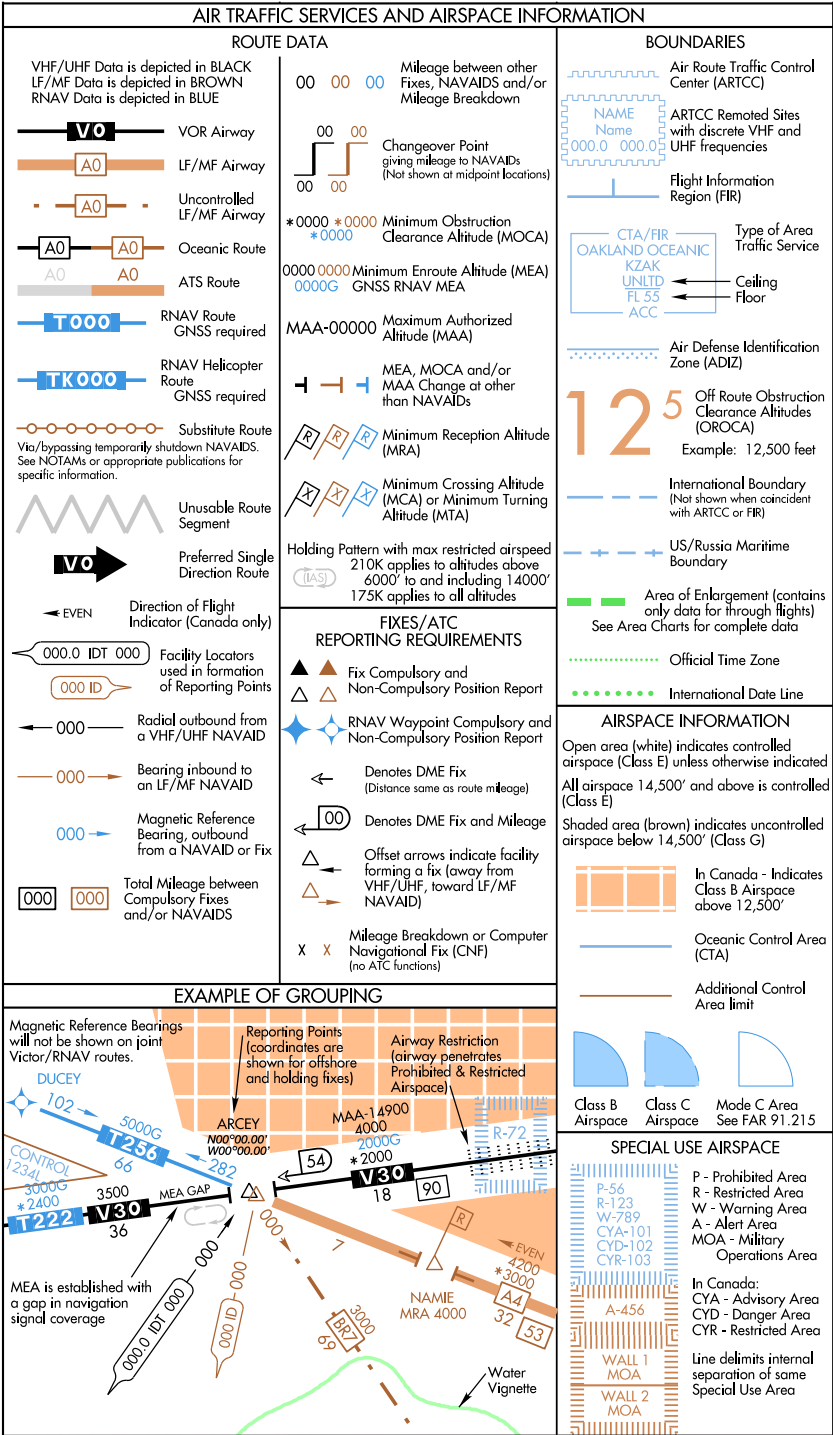

LEGEND 34.—IFR En Route Low Altitude (U.S.)

# Appendix 1

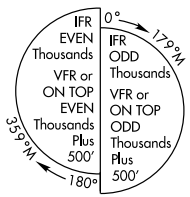
MILITARY TRAINING ROUTES (MTRs)	CRUISING ALTITUDES - U.S.	MISCELLANEOUS
<p>MTRs 5 NM or less both sides of centerline</p> <p>IR-000 →</p> <p>VR-000 →</p> <p>MTRs greater than 5 NM either or both sides of centerline</p> <p>IR-000 →</p> <p>VR-000 →</p> <p>Arrow indicates direction of route</p> <p>See MTR tabs for altitude range information All IR and VR MTRs are shown except those VRs at or below 1500' AGL CAUTION: Inset charts do not depict MTRs</p>	<p>IFR within controlled airspace as assigned by ATC</p>  <p>VFR above 3000' AGL unless otherwise authorized by ATC IFR outside controlled airspace All courses are magnetic</p>	<p>ALTIMETER Altimeter setting change —4°E— 2010 Isogonic Line and Value All Mileages are Nautical except as noted. All Radicals and Bearings are magnetic except as noted. All Altitudes are MSL except as noted. All Time is Coordinated Universal Time (UTC), Days are local. ‡ During periods of Daylight Saving Time (DT), effective hours will be one hour earlier than shown. All states observe DT except Arizona and Hawaii. North American Datum of 1983 (NAD 83), for charting purposes is considered equivalent to World Geodetic System 1984 (WGS 84).</p> <p>FOR ADDITIONAL SYMBOL INFORMATION REFER TO THE CHART USER'S GUIDE</p>

LEGEND 35.—IFR En Route Low Altitude (U.S.)



AIRCRAFT EQUIPMENT SUFFIXES	
SUFFIX	Aircraft Equipment Suffixes
	<b>NO DME</b>
/X	No transponder
/T	Transponder with no Mode C
/U	Transponder with Mode C
	<b>DME</b>
/D	No transponder
/B	Transponder with no Mode C
/A	Transponder with Mode C
	<b>TACAN ONLY</b>
/M	No transponder
/N	Transponder with no Mode C
/P	Transponder with Mode C
	<b>AREA NAVIGATION (RNAV)</b>
/Y	LORAN, VOR/DME, or INS with no transponder
/C	LORAN, VOR/DME, or INS, transponder with no Mode C
/I	LORAN, VOR/DME, or INS, transponder with Mode C
	<b>ADVANCED RNAV WITH TRANSPONDER AND MODE C</b> (if an aircraft is unable to operate with a transponder and/or Mode C, it will revert to the appropriate code listed above under Area Navigation.)
/E	Flight Management System (FMS) with en route, terminal, and approach capability. Equipment requirements are: (a) Dual FMS which meets the specifications of AC 25-15, Approval of Flight Management Systems in Transport Category Airplanes; AC 20-129, Airworthiness Approval of Vertical Navigation (VNAV) Systems for use in the U.S. NAS and Alaska; AC 20-130, Airworthiness Approval of Navigation or Flight Management Systems Integrating Multiple Navigation Sensors; or equivalent criteria as approved by Flight Standards. (b) A flight director and autopilot control system capable of following the lateral and vertical FMS flight path. (c) At least dual inertial reference units (IRU's). (d) A database containing the waypoints and speed/altitude constraints for the route and/or procedure to be flown that is automatically loaded into the FMS flight plan. (e) An electronic map. (U.S. and U.S. territories only unless otherwise authorized.)
/F	A single FMS with en route, terminal, and approach capability that meets the equipment requirements of /E, (a) through (d), above. (U.S. and U.S. territories only unless otherwise authorized.)
/G	Global Positioning System (GPS)/Global Navigation Satellite System (GNSS) equipped aircraft with en route and terminal capability.
/R	Required Navigational Performance (Denotes capability to operate in RNP designated airspace and routes)
/W	Reduced Vertical Separation Minima (RVSM)

LEGEND 36.—Aircraft Equipment Suffixes.

## AIR NAVIGATION RADIO AIDS

### Standard High Altitude Service Volume

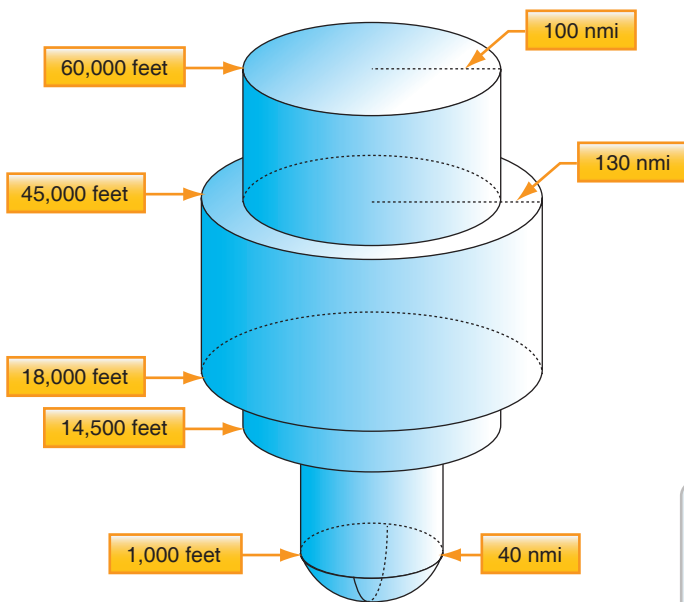

### Standard Low Altitude Service Volume

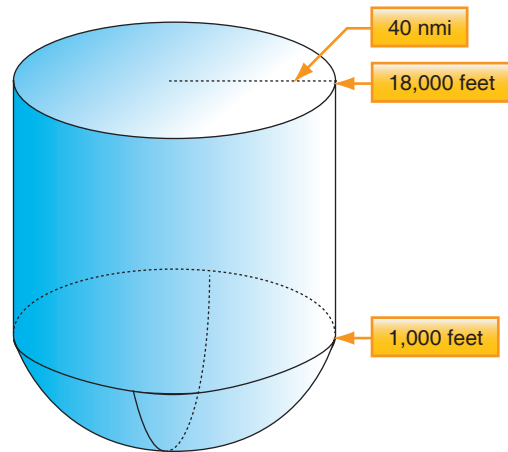

Note: All elevations shown are with respect to the station's site elevation (AGL). Coverage is not available in a cone of airspace directly above the facility.

### Standard Terminal Service Volume

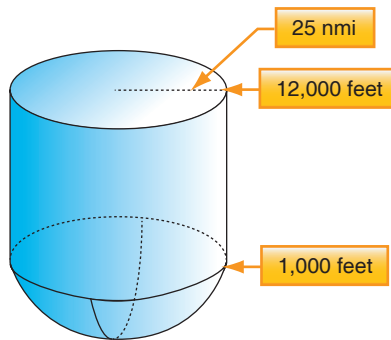

LEGEND 37.—Air Navigation Radio Aids.

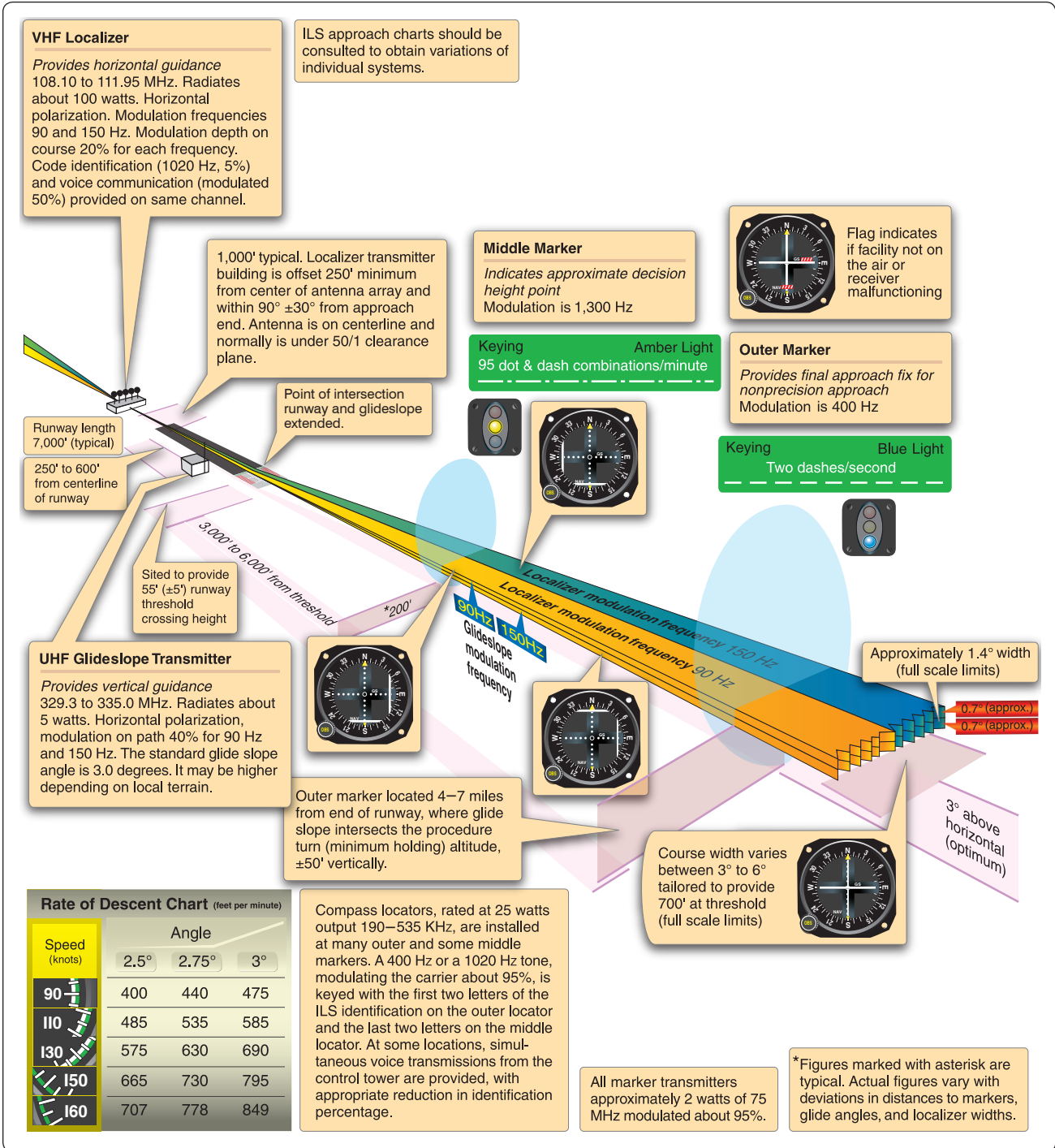

LEGEND 38.—ILS Standard Characteristics and Terminology.

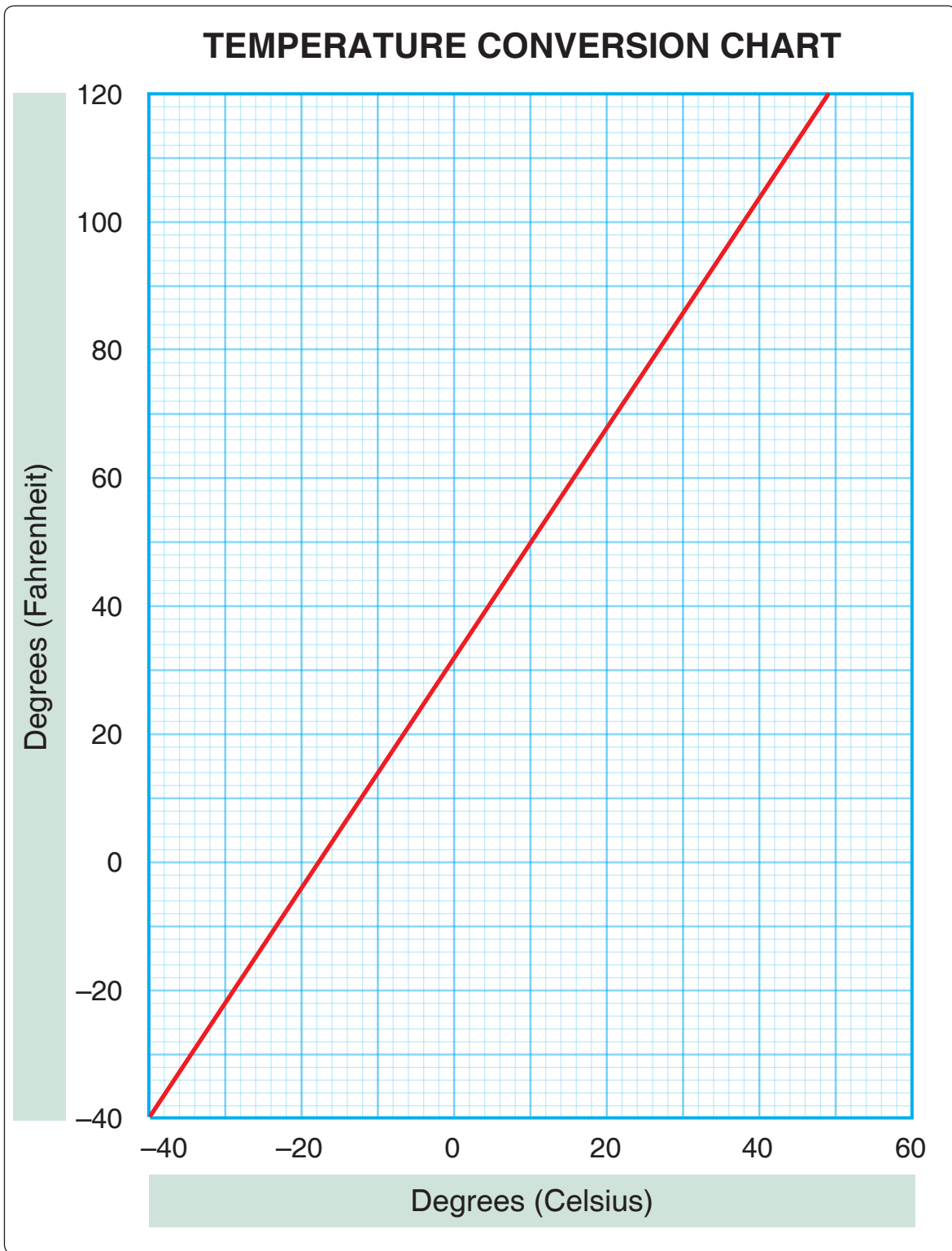

LEGEND 39.—Temperature Conversion Chart.

## **APPENDIX 2**



VALID 1600Z FOR USE 0900-1500Z. TEMPS NEG ABV 24000									
FT	3000	6000	9000	12000	18000	24000	30000	34000	39000
EMI	2807	2715-07	2728-10	2842-13	2867-21	2891-30	751041	771150	780855
ALB	0210	9900-07	2714-09	2728-12	2656-19	2777-28	781842	760150	269658
PSB		1509+04	2119+01	2233-04	2262-14	2368-26	781939	760850	780456
STL	2308	2613+02	2422-03	2431-08	2446-19	2461-30	760142	782650	760559

FIGURE 2.—Wind and Temperatures Aloft Forecast.

### STANDARD CONVERSION

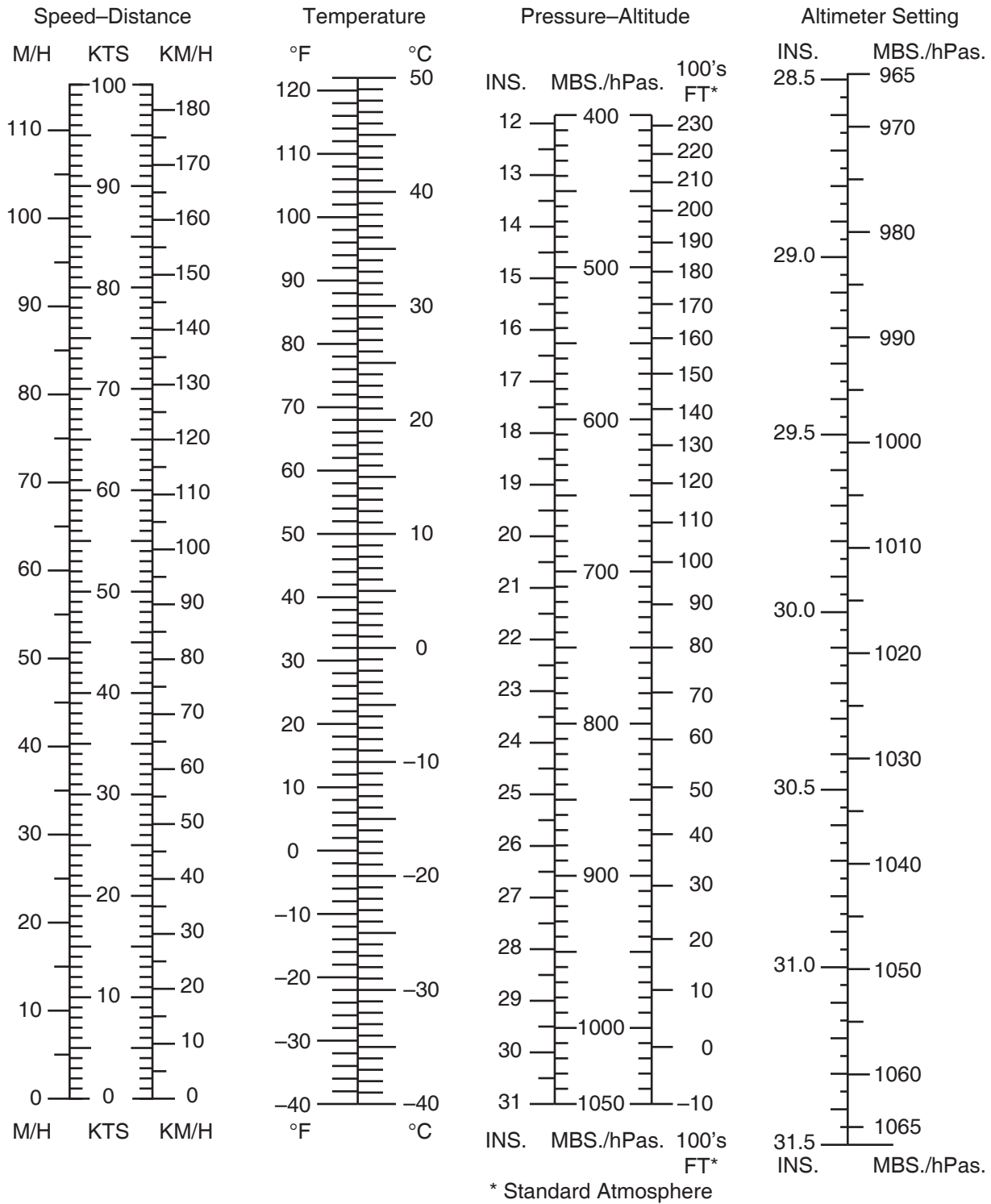

FIGURE 3.—Standard Conversion Chart.



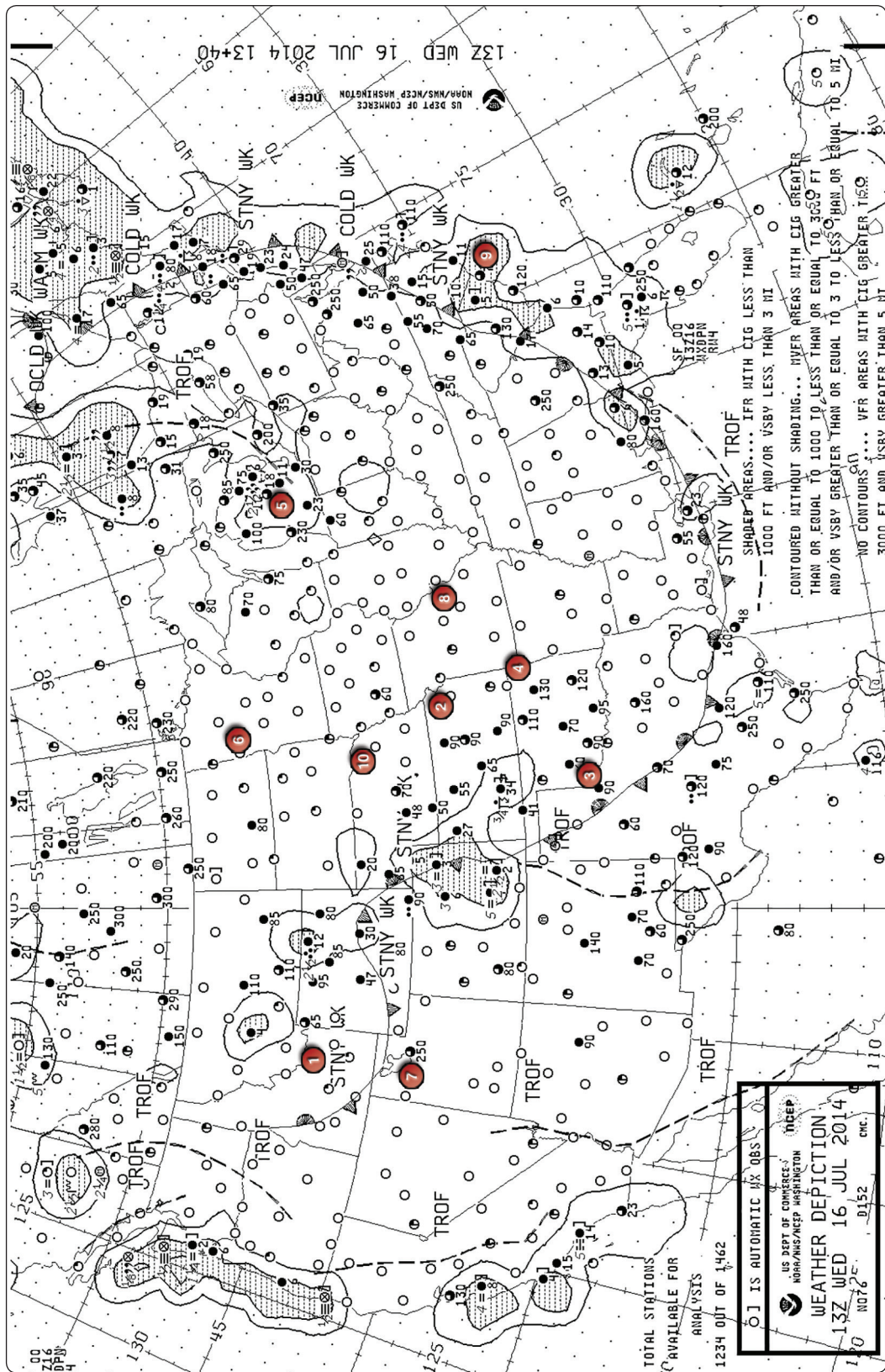

FIGURE 4.—Weather Depiction Chart.

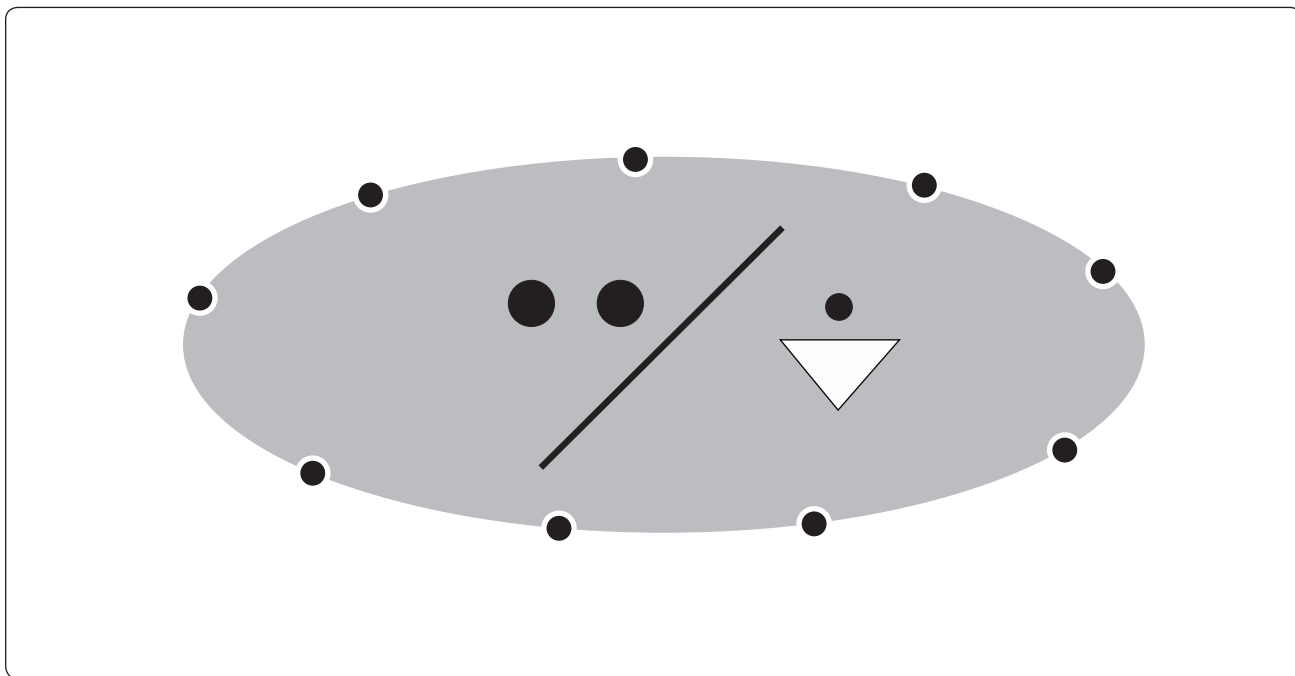

FIGURE 5.—Symbol Used on Low-Level Significant Weather Prognostic Chart.

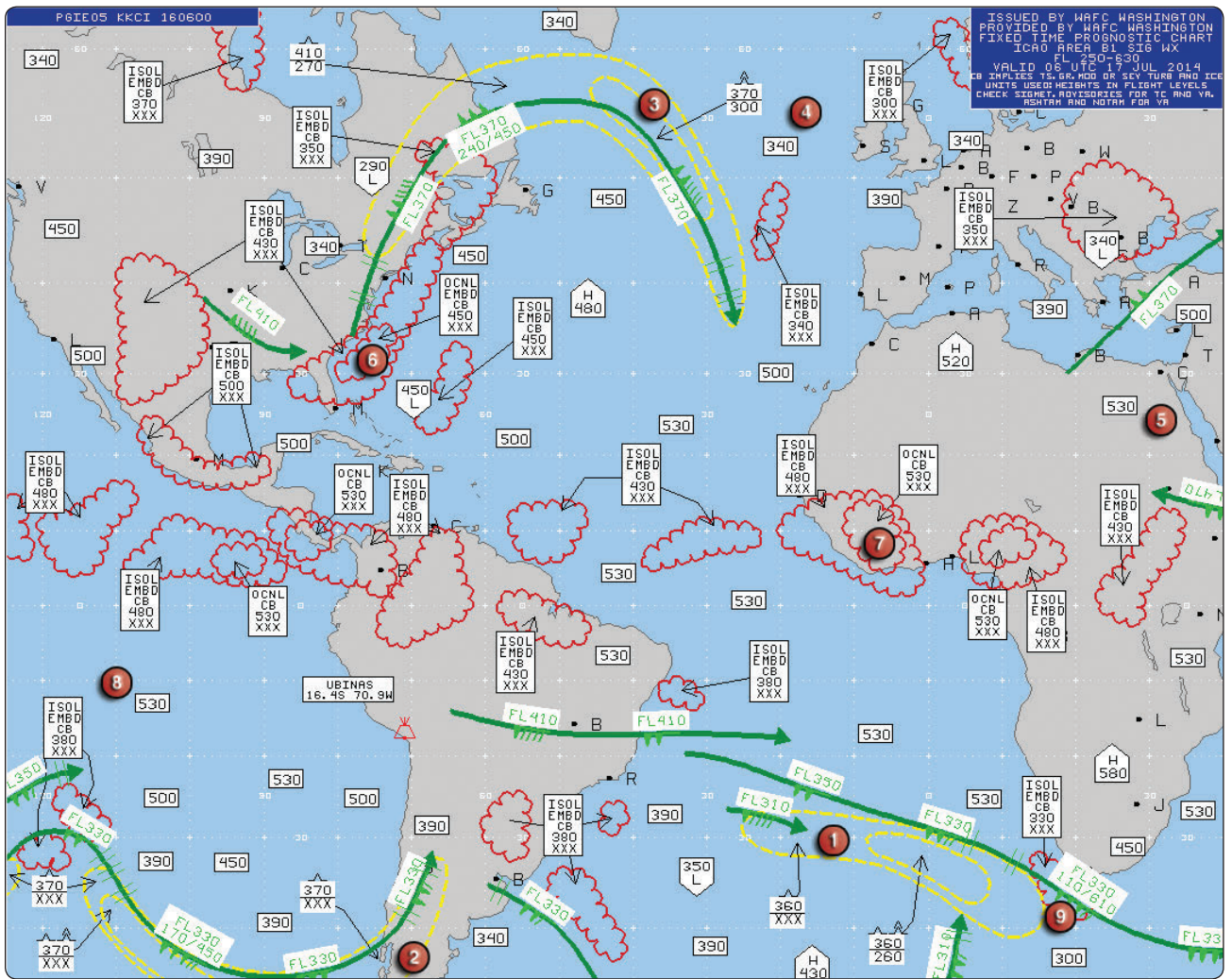

FIGURE 7.—High-Level Significant Weather Prognostic Chart.

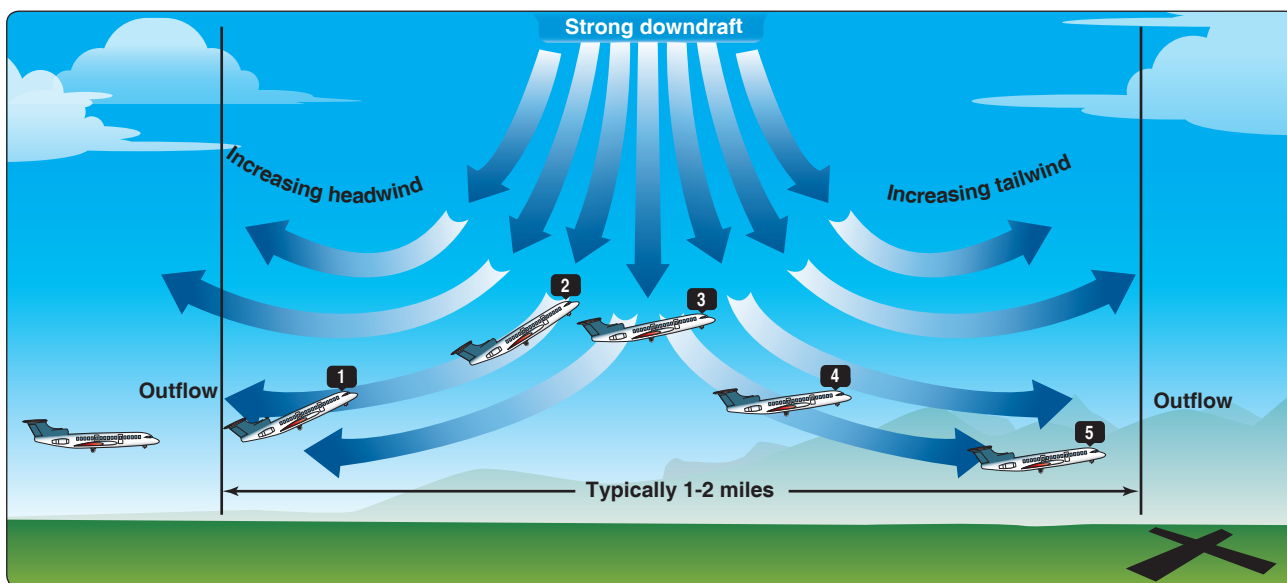

FIGURE 13.—Microburst Section Chart.

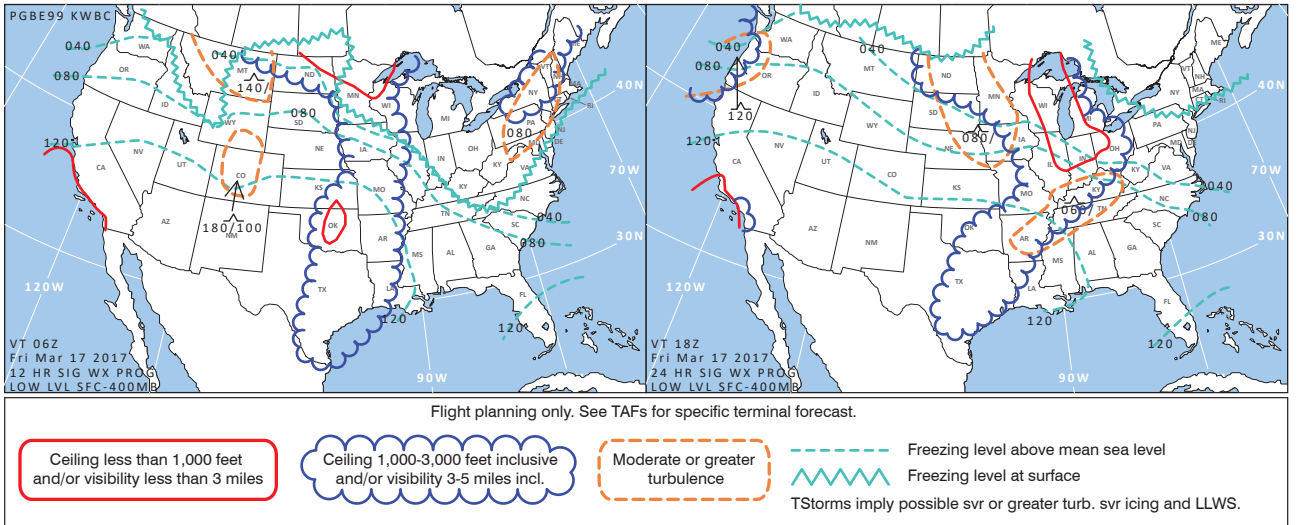

FIGURE 18.—U.S. Low-Level Significant Weather Prognostic Charts.

# Appendix 2

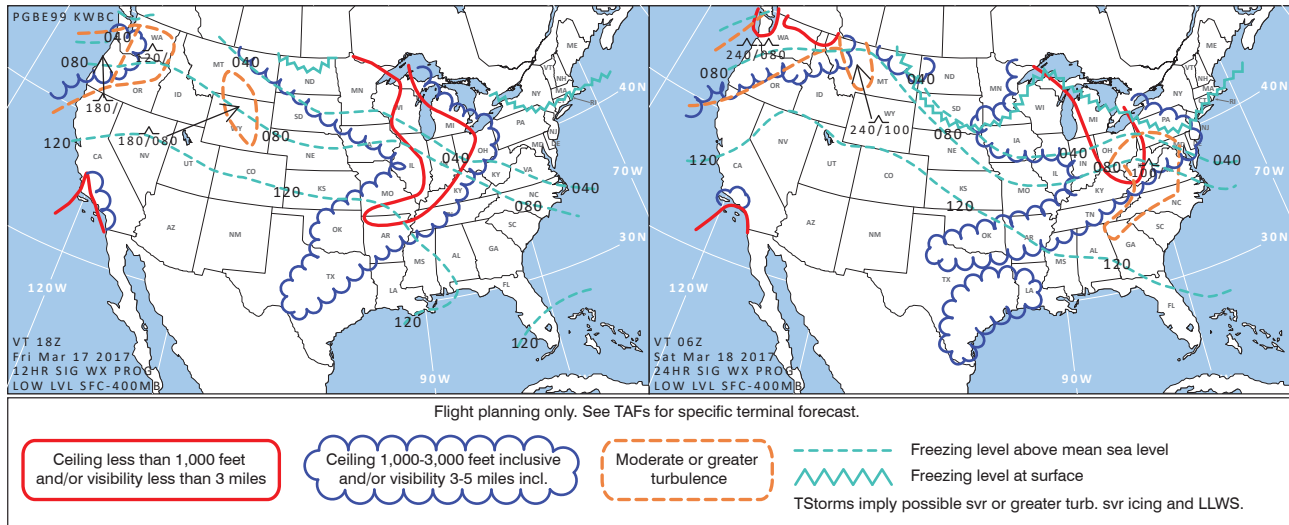

FIGURE 19.—U.S. Low-Level Significant Weather Prognostic Charts.

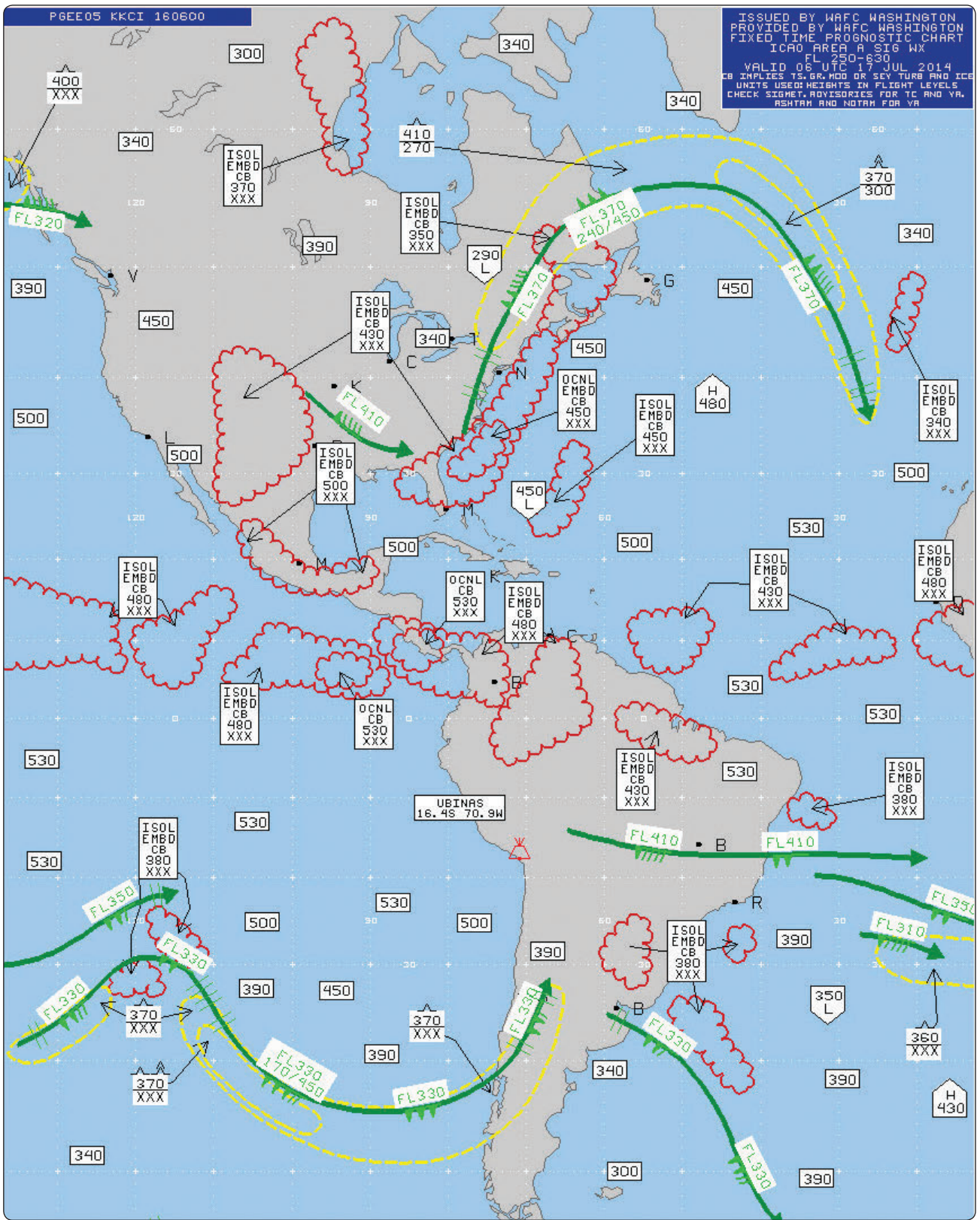

FIGURE 20.—High-Level Significant Weather Prognostic Chart.

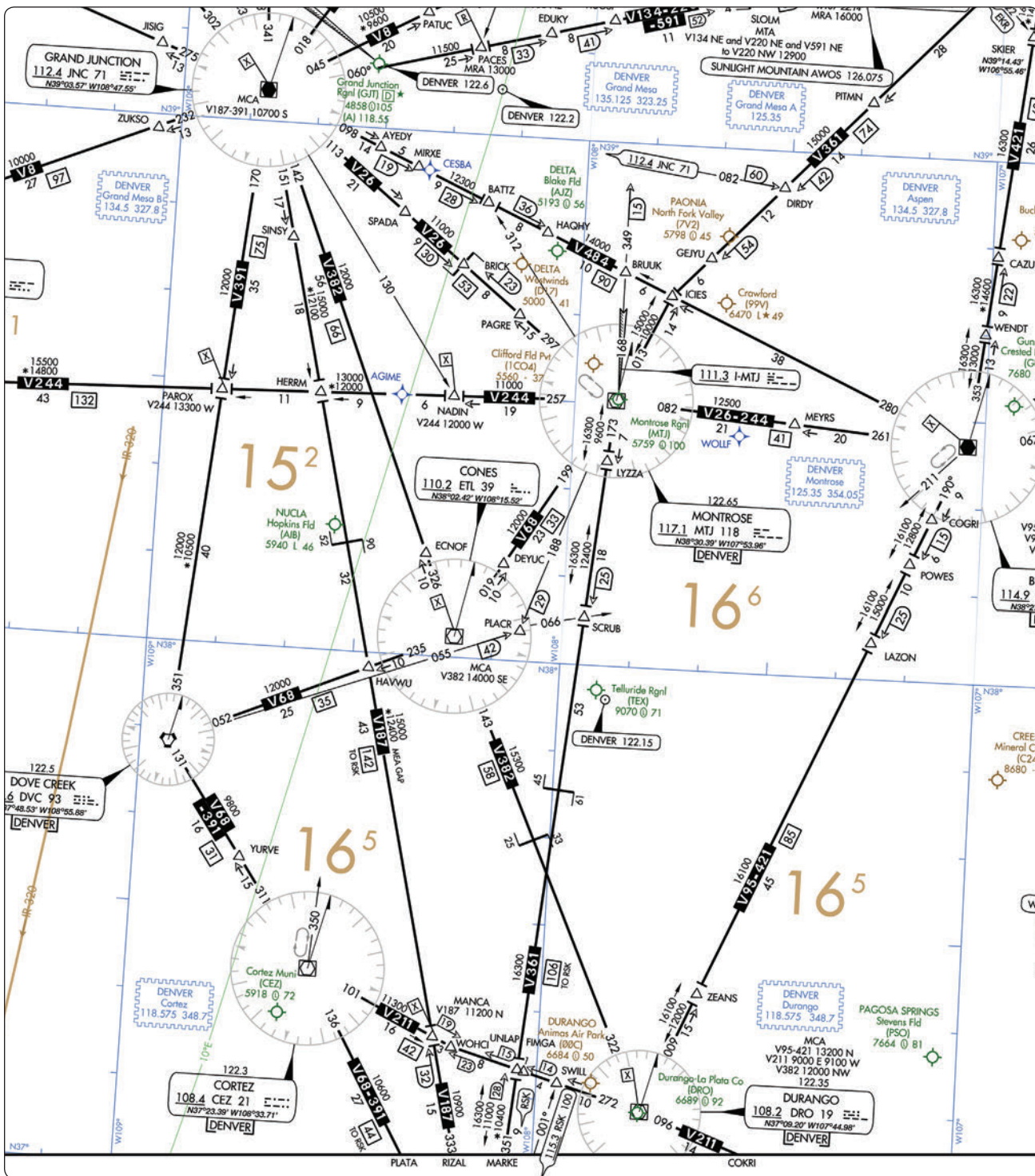

FIGURE 24.—En Route Low-Altitude Chart Segment.

NOTE: Chart is not to scale and should not be used for navigation. Chart is for testing purposes only.



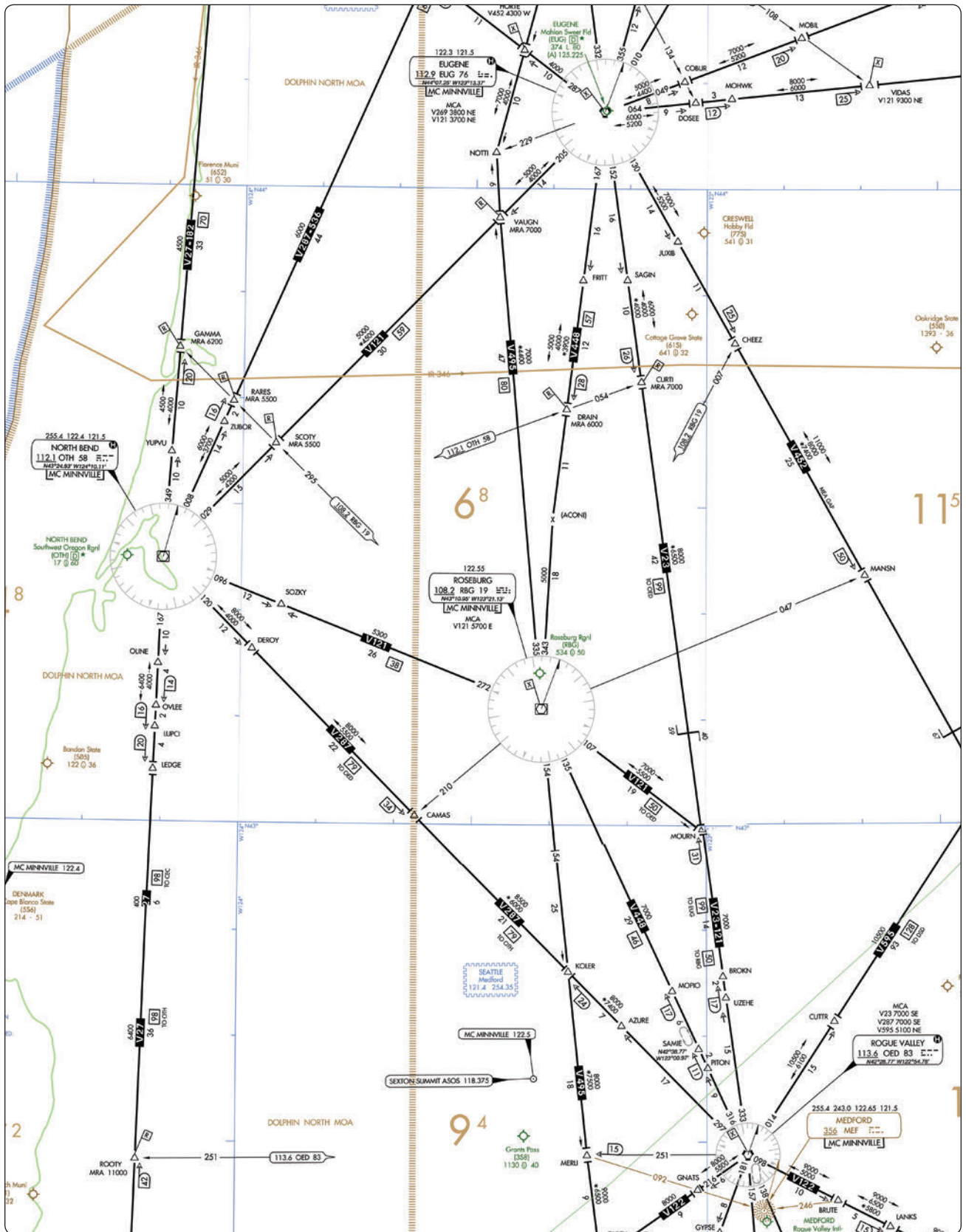

FIGURE 31.—En Route Low-Altitude Chart Segment.

NOTE: Chart is not to scale and should not be used for navigation. Chart is for testing purposes only.

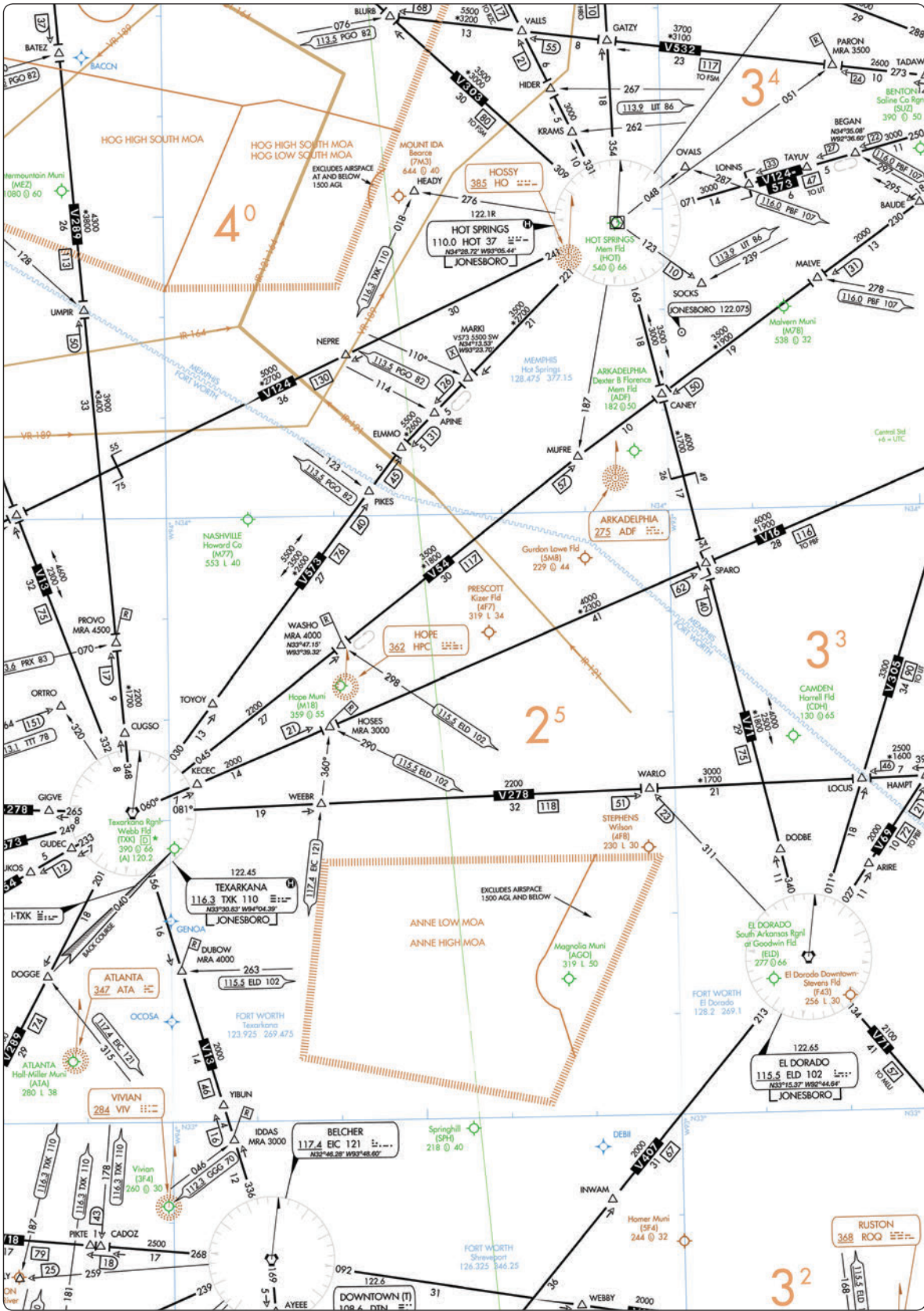

FIGURE 34.—En Route Low-Altitude Chart Segment.

NOTE: Chart is not to scale and should not be used for navigation. Chart is for testing purposes only.

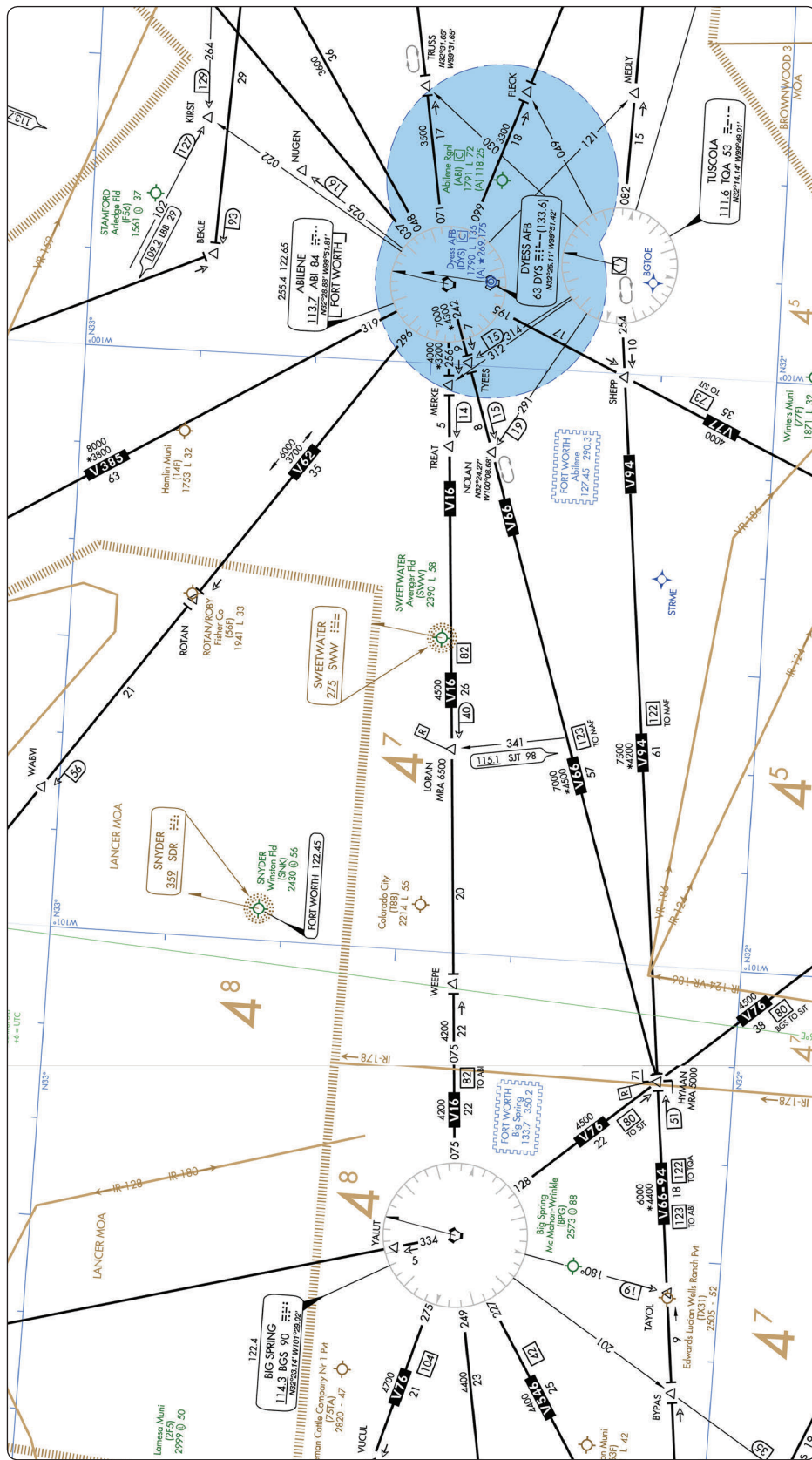

FIGURE 40.—En Route Low-Altitude Chart Segment.

NOTE: Chart is not to scale and should not be used for navigation. Chart is for testing purposes only.



FIGURE 47.—En Route Low-Altitude Chart Segment.

NOTE: Chart is not to scale and should not be used for navigation. Chart is for testing purposes only.



FIGURE 48.—CDI—NAV 1.

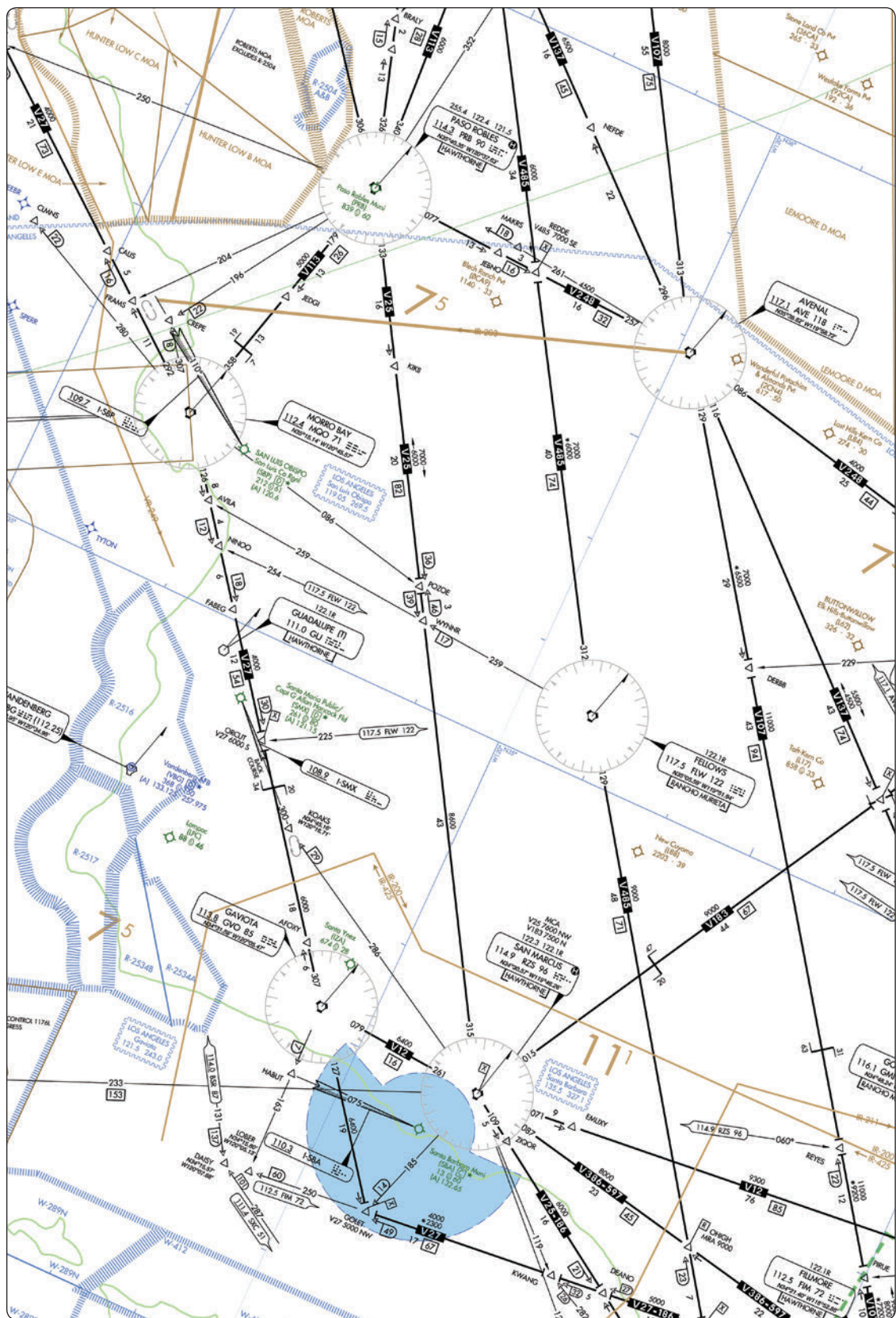

FIGURE 53.—En Route Low-Altitude Chart Segment.

NOTE: Chart is not to scale and should not be used for navigation. Chart is for testing purposes only.

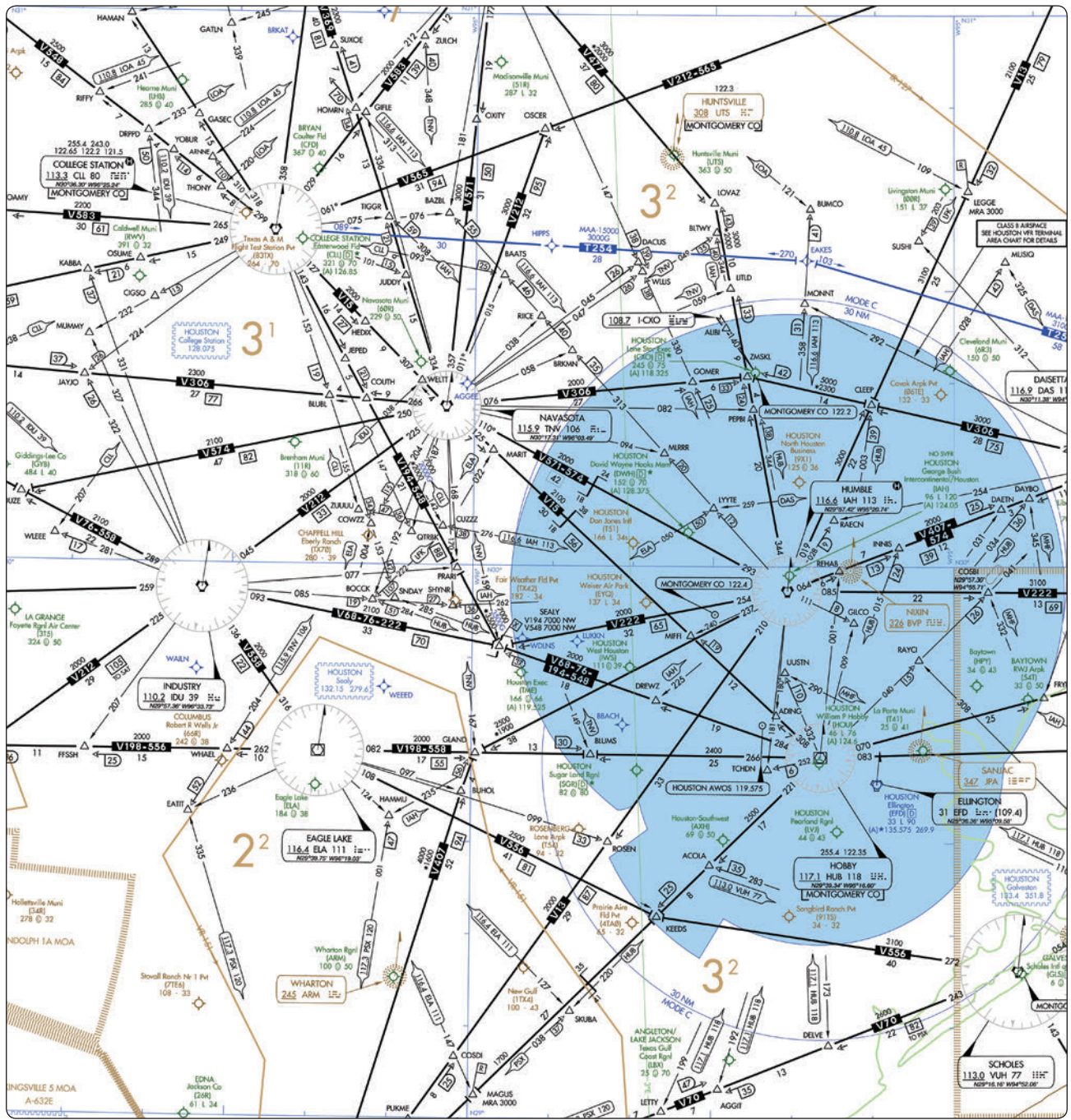

FIGURE 59.—En Route Low-Altitude Chart Segment.

NOTE: Chart is not to scale and should not be used for navigation. Chart is for testing purposes only.

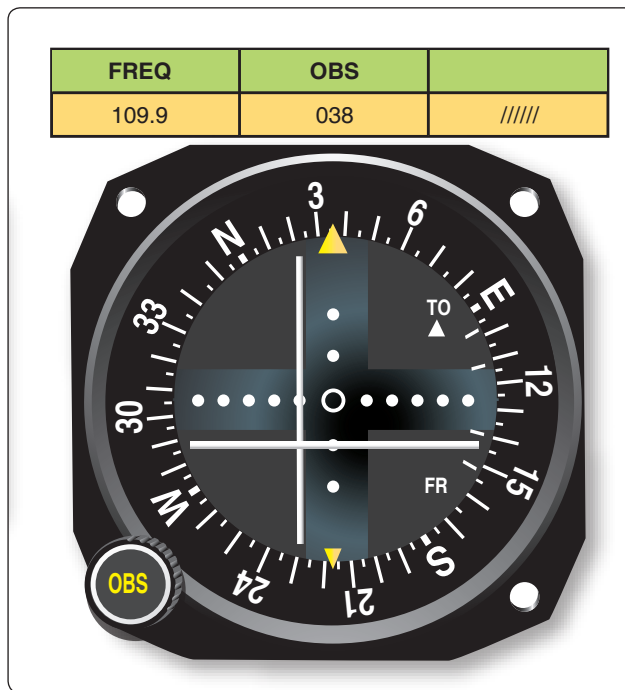

FIGURE 61.—CDI Indicator.



LOUISIANA VOR RECEIVER CHECKPOINTS						
Facility Name (Arpt Name)	Freq/Ident	Type Check Pt. Gnd. AB/ALT	Azimuth Mag	Dist. from Fac. N.M.	Checkpoint Description	
<b>Alexandria</b> (Alexandria Intl).....	116.1/AEX	G	328	4.3	On runup Rwy 32.	
<b>Baton Rouge</b> (Baton Rouge Metro, Ryan).	116.5/BTR	A/1500	063	7.2	Over water tank W side of arpt.	
<b>Lafayette</b> (Lafayette Rgnl/Paul Fournet Fld)	109.8/LFT	A/1000	343	22.1	Over rotating beacon at St. Landry Parish—Ahart Fld. arpt.	
	109.8/LFT	G	355	0.5	On Twy F run up area Rwy 04L.	
	109.8/LFT	G	341	0.9	On Twy B run up area Rwy 11.	
	109.8/LFT	G	025	1.4	On Twy J run up area Rwy 22L.	
	109.8/LFT	G	039	0.8	On Twy B run up area Rwy 29.	
<b>Lake Charles</b> (Lake Charles Rgnl) .....	113.4/LCH	A/1000	253	6.2	Over rotg bcn on twr.	
<b>Monroe</b> (Monroe Rgnl).....	117.2/MLU	G	212	0.7	On Twy G South of twr.	
<b>Natchez</b> (Concordia Parish).....	110.0/HEZ	A/1000	247	10.5	Over hangar NW end of fld.	
<b>Reserve</b> (St John The Baptist Parish).....	110.8/RQR	A/1500	270	16.8	Over center of bridge.	
<b>Tibby</b> (Houma—Terrebonne) .....	112.0/TBD	A/1000	121	10.7	Over intersection of Rwys 18-36 and 12-30.	
<b>Tibby</b> (Thibodaux Muni).....	112.0/TBD	A/1000	356	5.0	Over microwave twr near arpt.	

**84** **LOUISIANA**

---

**LAFAYETTE RGNL** (LFT) 2 SE UTC-6(-5DT) N30°12.30' W91°59.27' **HOUSTON**  
 42 B S4 FUEL 100LL, JET A OX 1, 4 Class I, ARFF Index B NOTAM FILE LFT **H-7D, L-21B, 22E, GOMC**  
**RWY 04R-22L:** H8001X150 (ASPH-GRVD) S-140, D-170, 2S-175, **IAP AD**  
 2D-290 MIRL  
**RWY 04R:** REIL. PAPI(P4L)—GA 3.0° TCH 53'. Pole. Rgt tfc.  
**RWY 22L:** MALSR. PAPI(P4L)—GA 3.0° TCH 52'. Thld dsplcd 342'.  
 Trees.  
**RWY 11-29:** H5401X148 (ASPH-GRVD) S-85, D-110, 2S-140,  
 2D-175 MIRL  
**RWY 11:** REIL. PAPI(P4L)—GA 3.0° TCH 35'. Trees. Rgt tfc.  
**RWY 29:** REIL. PAPI(P4L)—GA 3.0° TCH 35'. Tree.  
**RWY 04L-22R:** H4099X75 (ASPH) S-25, D-32 MIRL  
**RWY 04L:** REIL. PAPI(P2L)—GA 3.0° TCH 26'. Tree.  
**RWY 22R:** REIL. PAPI(P2L)—GA 3.0° TCH 27'. Tree. Rgt tfc.

**RUNWAY DECLARED DISTANCE INFORMATION**  
**RWY 04L:**TORA-4099 TODA-4099 ASDA-4099 LDA-4099  
**RWY 04R:**TORA-8001 TODA-8001 ASDA-8001 LDA-8001  
**RWY 11:** TORA-5401 TODA-5401 ASDA-5401 LDA-5401  
**RWY 22L:**TORA-8001 TODA-8001 ASDA-8001 LDA-7659  
**RWY 22R:**TORA-4099 TODA-4099 ASDA-4099 LDA-4099  
**RWY 29:** TORA-5401 TODA-5401 ASDA-5401 LDA-5401

**ARRESTING GEAR/SYSTEM**  
**RWY 04R:** EMAS  
**RWY 22L:** EMAS

**AIRPORT REMARKS:** Attended continuously. Numerous birds on and invof arpt. PPR for unscheduled air carrier ops with more than 30 passenger seats call arpt manager 337-266-4400. Rwy 04L-22R not avbl for air carrier ops with more than 30 passenger seats. Ctc ground control prior to push back from terminal. 155' oil rig 1 NM southeast of arpt. Rwy 22L runway visual range touchdown avbl. Twy B between Twy C and Twy D clsd to acct with wingspan over 80'. Twy F south of Twy B clsd to single wheel acct over 25,000 lbs and dual wheel acct over 32,000 lbs. Twy F south of Twy B reduces to 40' wide. When twr clsd ACTIVATE MALSR Rwy 22L—CTAF, MIRL Rwy 04L-22R not avbl.

**WEATHER DATA SOURCES:** ASOS (337) 237-8153 HIWAS 109.8 LFT.  
**COMMUNICATIONS:** CTAF 118.5 ATIS 134.05 UNICOM 122.95  
 RCO 122.35 (DE RIDDER RADIO)  
 (R) APP/DEP CON 121.1 (020°-210°) 128.7 (211°-019°) (1130-0430Z‡)  
 (R) HOUSTON CENTER APP/DEP CON 126.35 (0430-1130Z‡)  
 TOWER 118.5 (1130-0430Z‡) GND CON 121.8 CLNC DEL 125.55  
**AIRSPACE:** CLASS C svc ctc APP CON svc 1130-0430Z‡ other times CLASS E.  
**RADIO AIDS TO NAVIGATION:** NOTAM FILE LFT.  
 (L) VORTACW 109.8 LFT Chan 35 N30°11.63' W91°59.55' at fld. 36/3E. HIWAS.  
 LAFFS NDB (LOM) 375 LF N30°17.36' W91°54.48' 216° 6.5 NM to fld. Unmonitored when ATCT clsd.  
 ILS/DME 110.9 I-TYN Chan 46 Rwy 04R. Class IE.  
 ILS/DME 109.5 I-LFT Chan 32 Rwy 22L. Class IE. LOM LAFFS NDB. ILS and LOM unmonitored when ATCT clsd.  
 ASR (1130-0430Z‡)

FIGURE 64.—Excerpt from Chart Supplement (LFT).

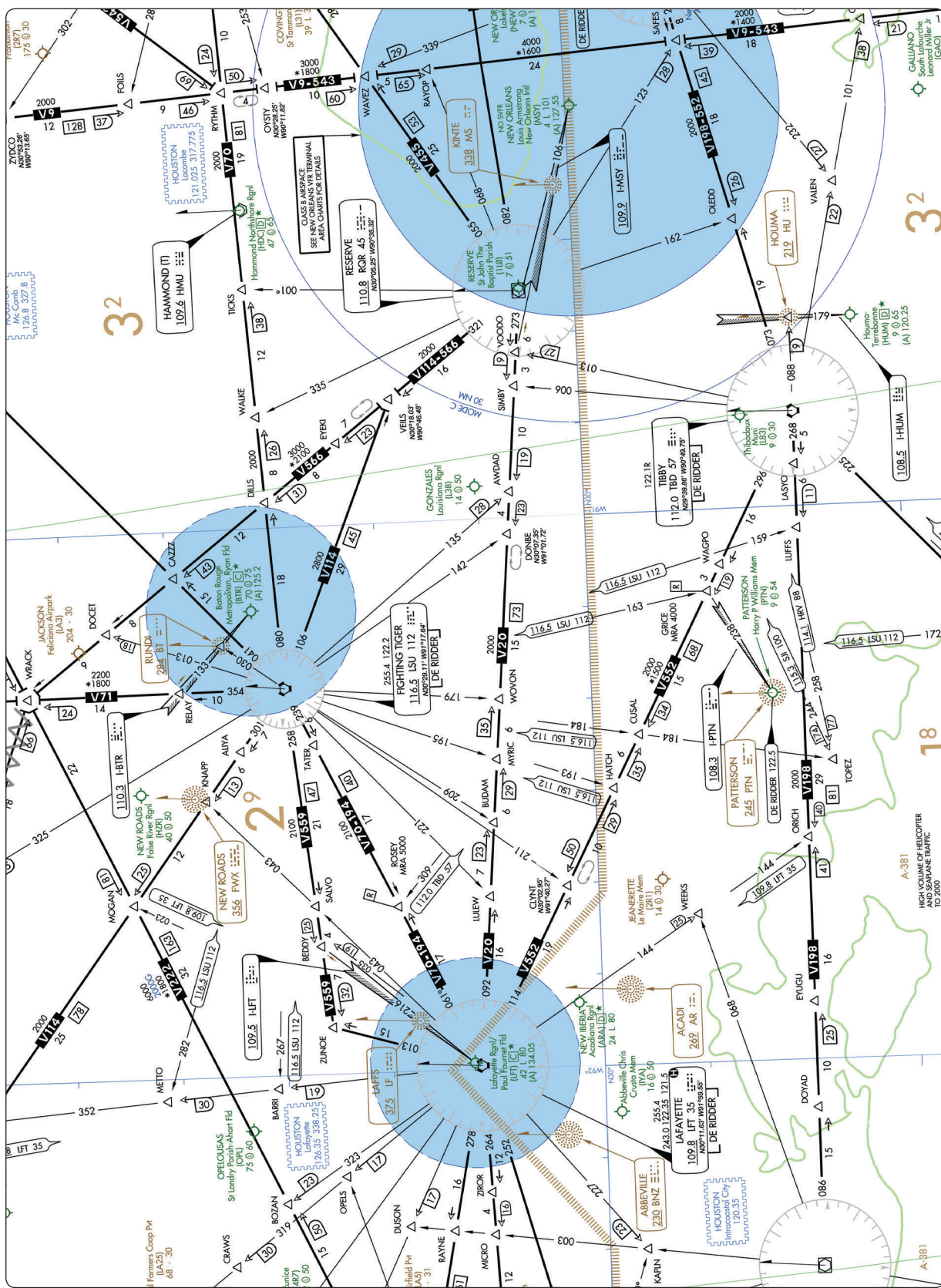

FIGURE 65.—En Route Low-Altitude Chart Segment.

NOTE: Chart is not to scale and should not be used for navigation. Chart is for testing purposes only.



FIGURE 66.—CDI and OBS Indicators.

Appendix 2

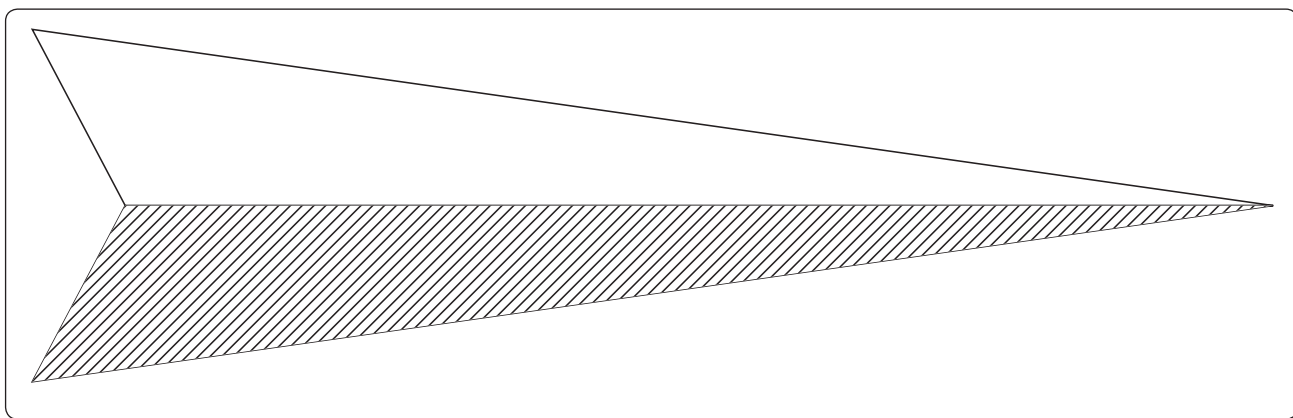

FIGURE 67.—Localizer Symbol.

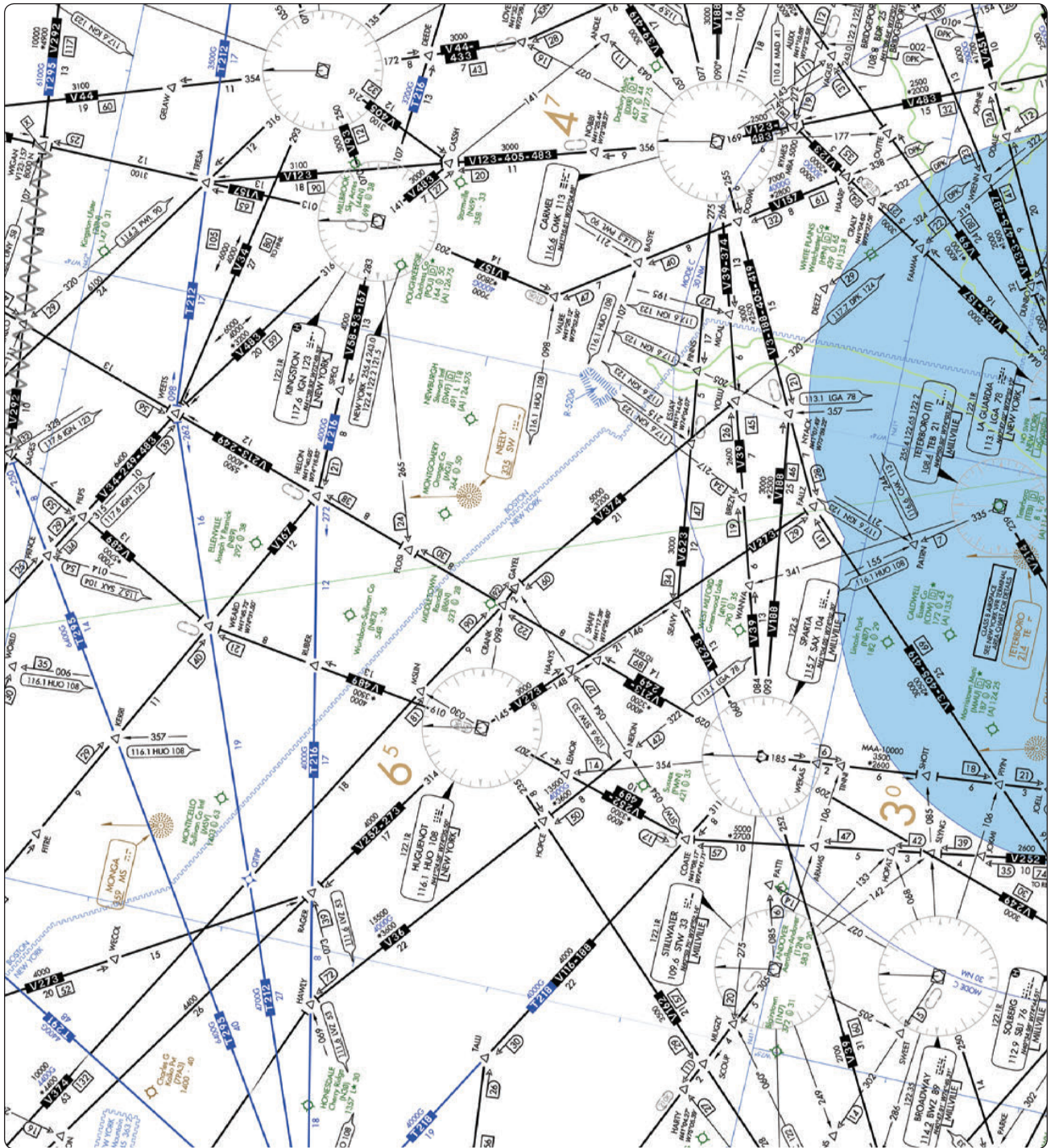

FIGURE 71.—En Route Low-Altitude Chart Segment.

NOTE: Chart is not to scale and should not be used for navigation. Chart is for testing purposes only.

Appendix 2

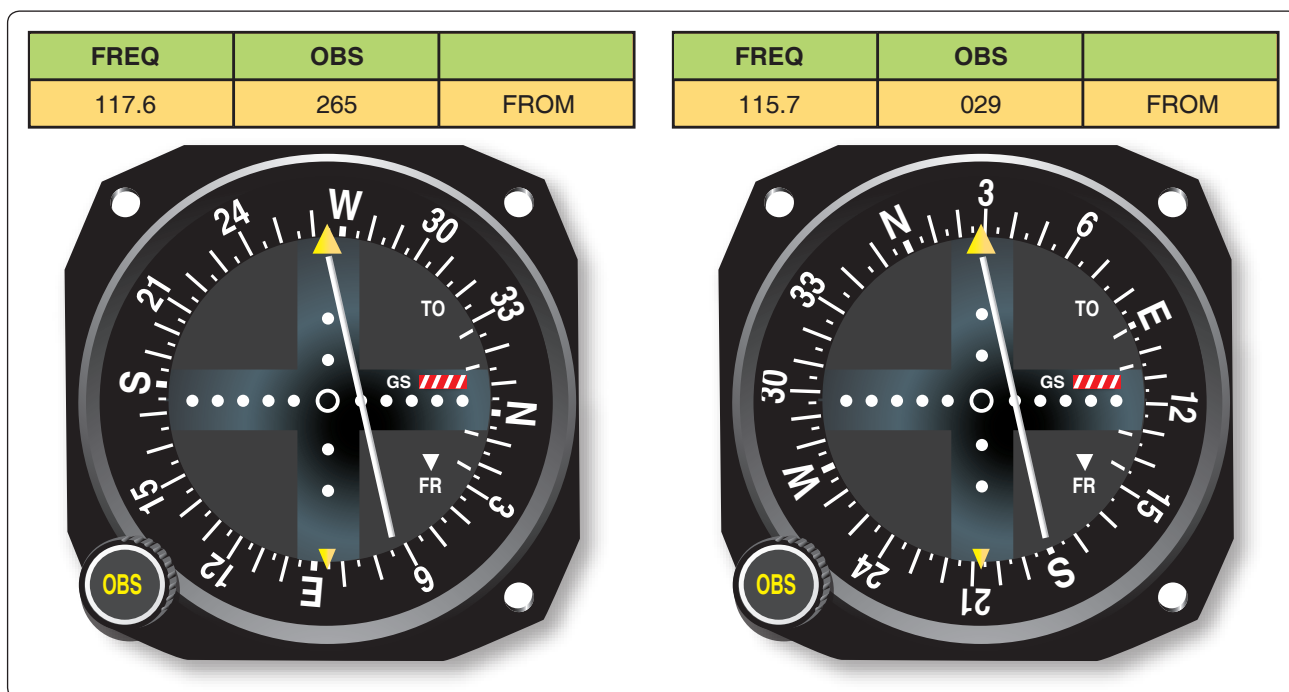
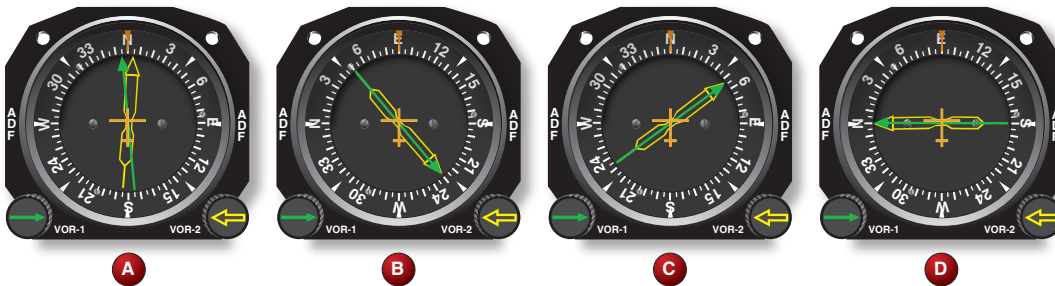

FIGURE 71A.—CDI and OBS Indicators.



**HELENA RGNL** (HLN)(KHLN) P (ARNG) 2 NE UTC-7(-6DT) N46°36.41' W111°58.97' **GREAT FALLS**  
 3877 B S4 FUEL 80, 100, 100LL, JET A OX 1, 3 LRA Class 1, ARFF Index B NOTAM FILE HLN H-1D, L-13C  
**RWY 09-27:** H9000X150 (ASPH-PFC) S-100, D-160, 2S-175, IAP, DIAP AD  
 2D-250 HIRL  
**RWY 09:** REIL. VASI(V4L)—GA 3.0° TCH 45'. Ground. 0.3% down.  
**RWY 27:** MALSR. VASI(V4L)—GA 3.0° TCH 47'. Rgt tfc.  
**RWY 05-23:** H4644X75 (ASPH-PFC) S-21, D-30 MIRL 1.2% up SW  
**RWY 05:** Road.  
**RWY 23:** PAPI(P2L)—GA 3.0° TCH 49'. Fence. Rgt tfc.  
**RWY 16-34:** H2989X75 (ASPH-PFC) S-21, D-30 MIRL 1.7% up SE  
**RWY 34:** Ground. Rgt tfc.  
**MILITARY SERVICE:** FUEL A+, JB (C406-442-2190. Opr 1200-0600Z†, OT \$150 fee, 90 min PPR.) (NC-80, 100, 100LL)  
**AIRPORT REMARKS:** Attended 1200-0800Z†. ARFF coverage provided for scheduled Part 121 air carriers only exc with prior approval—call 406-442-2821. Landing rights customs available call 406-449-5506. Rwy 16-34 and Rwy 05-23 (except between Twy F and Rwy 09-27) not available for air carrier use by acft with greater than 30 passenger seats. Twys A, B, and C between Twy A and Rwy 34 not available for air carrier use by acft with greater than 30 passenger seats. When tower closed ACTIVATE HIRL Rwy 09-27, MIRL Rwy 05-23 and Rwy 16-34, REIL Rwy 09. MALSR Rwy 27—CTAF. Ldg fee for all commercial acft and all acft over 10,000 pounds. Flight Notification Service (ADCUS) avbl. NOTE: See SPECIAL NOTICE.  
**MILITARY REMARKS:** ARNG Opr Mon-Fri 1400-0030Z†, except holidays. Exercise caution while taxiing, AASF ramp not stressed for large acft. Ctc flight ops for ramp advisory 126.2, DSN 324-3055/56, C406-324-3055/56. No trans svc Sat, Sun, holidays or after 2300Z† Mon-Fri.  
**WEATHER DATA SOURCES:** ASOS (406) 443-4317  
**COMMUNICATIONS:** CTAF 118.3 ATIS 120.4 UNICOM 122.95  
**RCO** 122.55 255.4 (GREAT FALLS RADIO)  
**APP/DEP CON** 119.5 229.4 (1300-0500Z†)  
**SALT LAKE CENTER APP/DEP CON** 133.4 285.4 (0500-1300Z†)  
**TOWER** 118.3 257.8 (1300-0500Z†) **GND CON** 121.9  
**ARNG OPS** 40.65 126.2 321.45  
**AIRSPACE:** CLASS D svc 1300-0500Z† other times CLASS E.  
**RADIO AIDS TO NAVIGATION:** NOTAM FILE HLN.  
**(H) VORTACW** 117.7 HLN Chan 124 N46°36.41' W111°57.21' 254° 1.2 NM to fld. 3823/16E.  
**VOR portion unusable:**  
 035°-050° byd 35 NM blo 12,000'  
 105°-165° byd 25 NM blo 17,000'  
 165°-185° byd 25 NM blo 13,500'  
 185°-230° byd 25 NM blo 17,500'  
 203°-213° byd 22 NM blo 13,000'  
 230°-270° byd 25 NM blo 12,500'  
**TACAN AZIMUTH and DME unusable:**  
 035°-070° byd 35 NM blo 13,000'  
 165°-185° byd 25 NM blo 13,500'  
 250°-300° byd 25 NM blo 14,000'  
 320°-035° byd 25 NM blo 13,000'  
**TACAN DME unusable:**  
 035°-070° byd 35 NM blo 13,000'  
 105°-150° byd 25 NM  
 105°-210° byd 15 NM blo 11,100'  
 105°-210° byd 20 NM blo 12,000'  
 150°-165° byd 25 NM blo 17,000'  
 165°-185° byd 25 NM blo 13,500'  
 185°-210° byd 25 NM  
 203°-213° byd 22 NM blo 13,000'  
 210°-250° byd 15 NM blo 12,000'  
 210°-250° byd 25 NM blo 17,500'  
 250°-300° byd 25 NM blo 14,000'  
 320°-035° byd 25 NM blo 13,000'  
**TACAN AZIMUTH unusable:**  
 105°-150° byd 15 NM  
 150°-165° byd 15 NM blo 17,000'  
 185°-210° byd 15 NM  
 210°-250° byd 15 NM blo 17,500'

**CAPITOL NDB (HW)** 335 CVP N46°36.40' W111°56.23' 258° 1.9 NM to fld. NDB unmonitored when ATCT clsd.  
**HAUSER NDB (MHW)** 386 HAU N46°34.13' W111°45.48' 268° 9.6 NM to fld. NDB unmonitored when HLN ATCT clsd.  
**ILS** 110.1 I-HLN Rwy 27. Unmonitored when ATCT closed. Localizer backcourse unusable byd 22° rgt of course, unusable within 2.7 DME.

**VOR RECEIVER CHECKPOINTS**

Facility Name (Arpt Name)	Freq/Ident	Type Check Pt. AB/ALT	Azimuth Fac. Mag	Dist. from Fac. N.M.	Checkpoint Description
<b>Helena</b> (Helena Rgnl) .....	117.7/HLN	G	238	0.7	On Twy E on South side of Rwy 27.
<b>Kalispell</b> (Glacier Park Intl) .....	113.2/FCA	A/4000	316	6.4	Over apch end Rwy 30.
<b>Lewistown</b> (Lewistown Muni) .....	112.0/LWT	A/5200	075	5.6	Over apch end Rwy 07.
<b>Livingston</b> .....	116.1/LVM	A/6500	237	5.5	Over northern most radio twr NE of city.
<b>Miles City</b> (Frank Wiley Field) .....	112.1/MLS	G	036	4.2	On twy leading to Rwy 30.
<b>Missoula</b> (Missoula Intl) .....	112.8/MSO	G	344	0.6	Terminal ramp east of Twy D.

FIGURE 76.—VOR Indications and Excerpts from Chart Supplement (HLN).

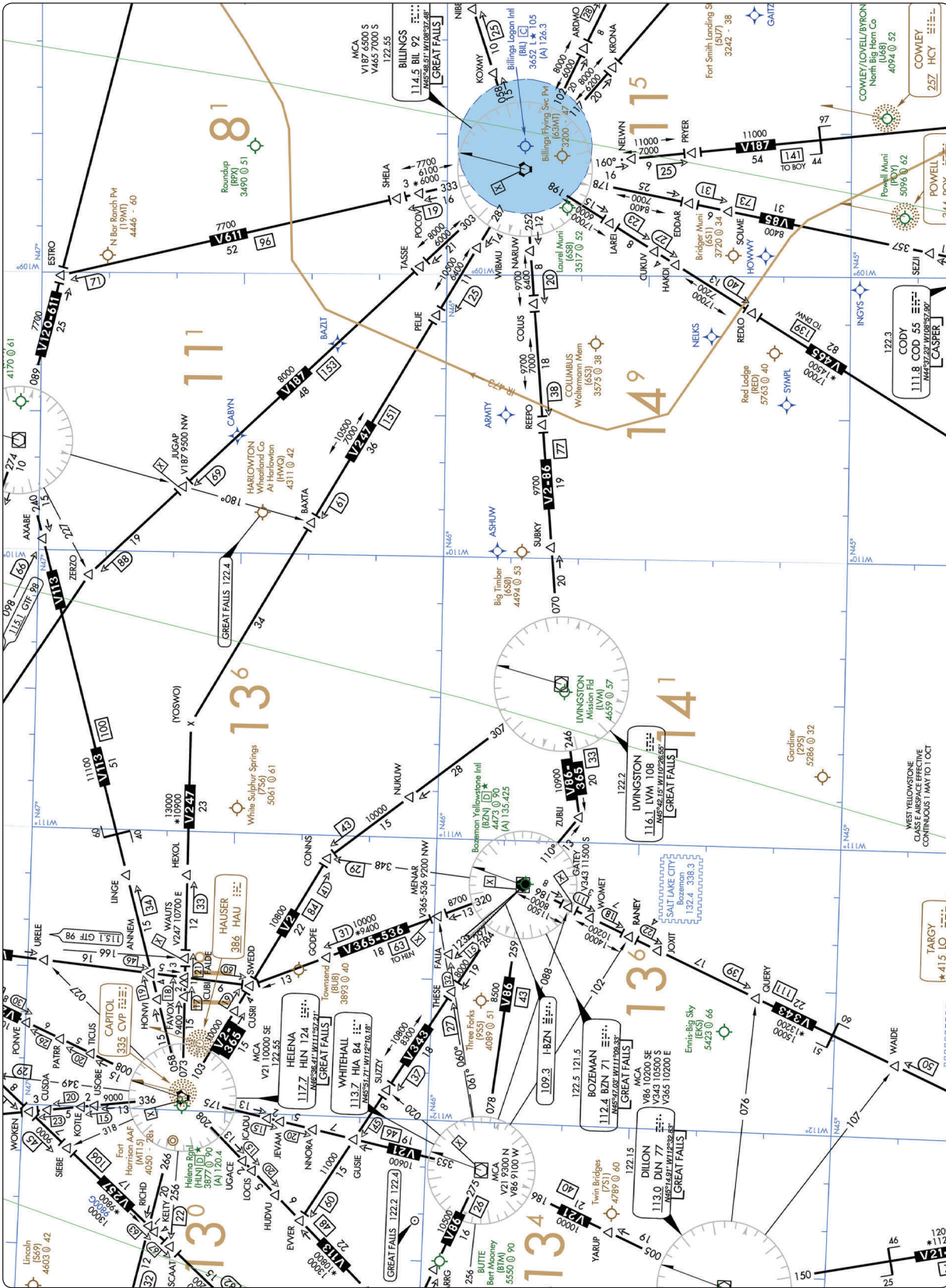

FIGURE 78.—En Route Low-Altitude Chart Segment.

NOTE: Chart is not to scale and should not be used for navigation. Chart is for testing purposes only.





FIGURE 81.—Dual VOR System, VOT Check.



FIGURE 82.—Dual VOR System, Accuracy Check.



FIGURE 86.—CDI and OBS Indicators.

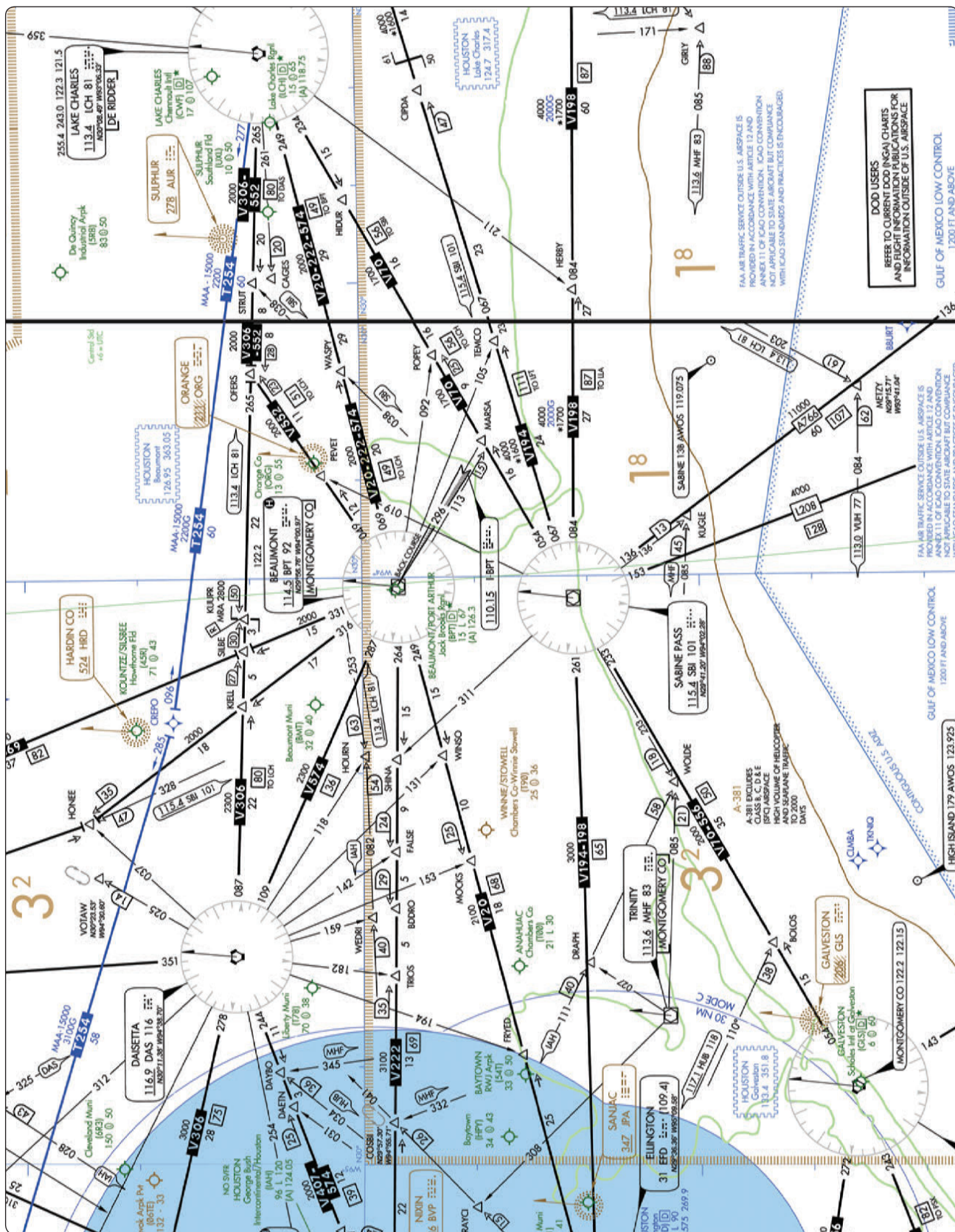

FIGURE 87.—En Route Low-Altitude Chart Segment.

NOTE: Chart is not to scale and should not be used for navigation. Chart is for testing purposes only.



FIGURE 88.—CDI and OBS Indicators.

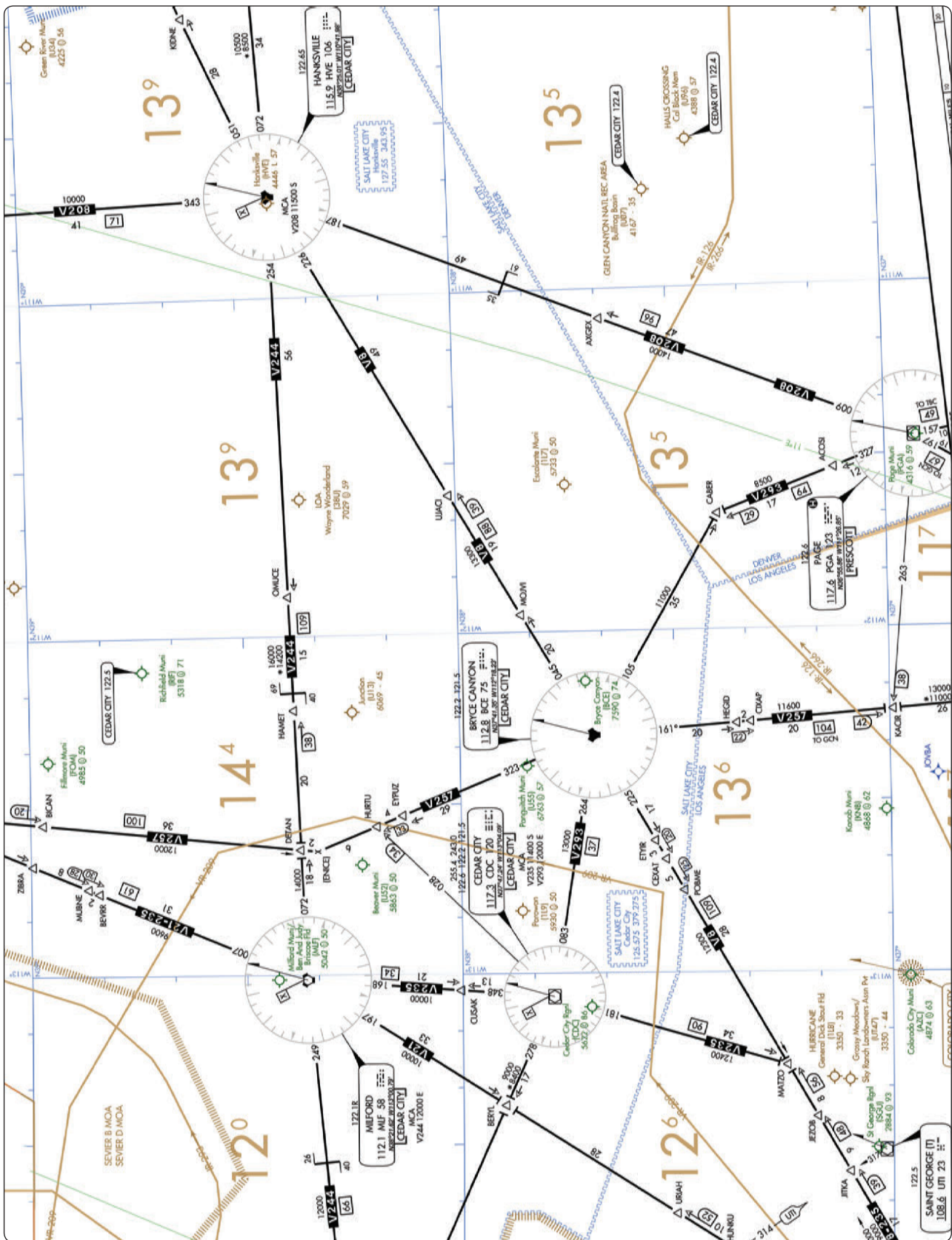

FIGURE 89.—En Route Low-Altitude Chart Segment.

NOTE: Chart is not to scale and should not be used for navigation. Chart is for testing purposes only.



FIGURE 90.—CDI/OBS Indicators.

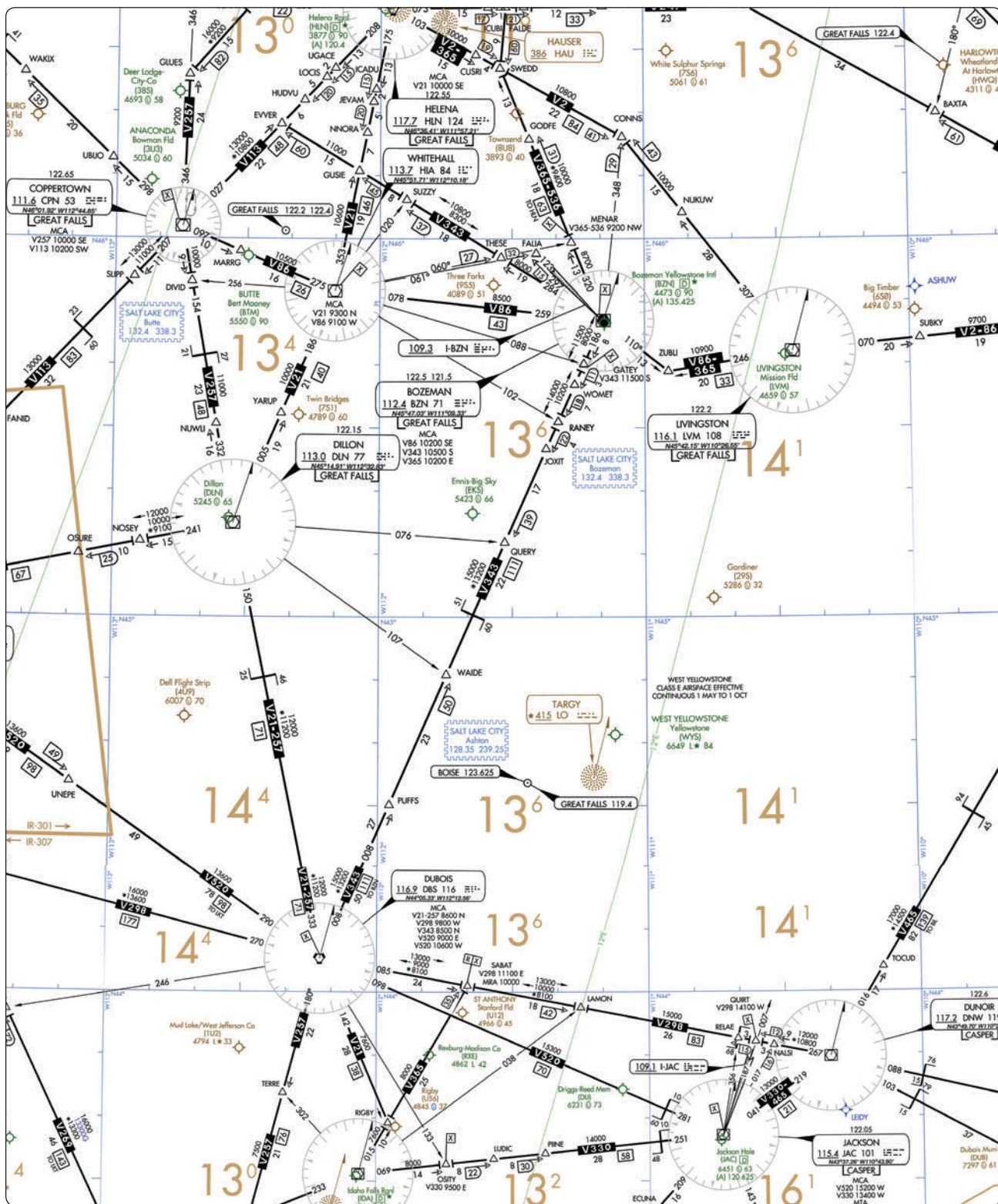

FIGURE 91.—En Route Low-Altitude Chart Segment.

NOTE: Chart is not to scale and should not be used for navigation. Chart is for testing purposes only.



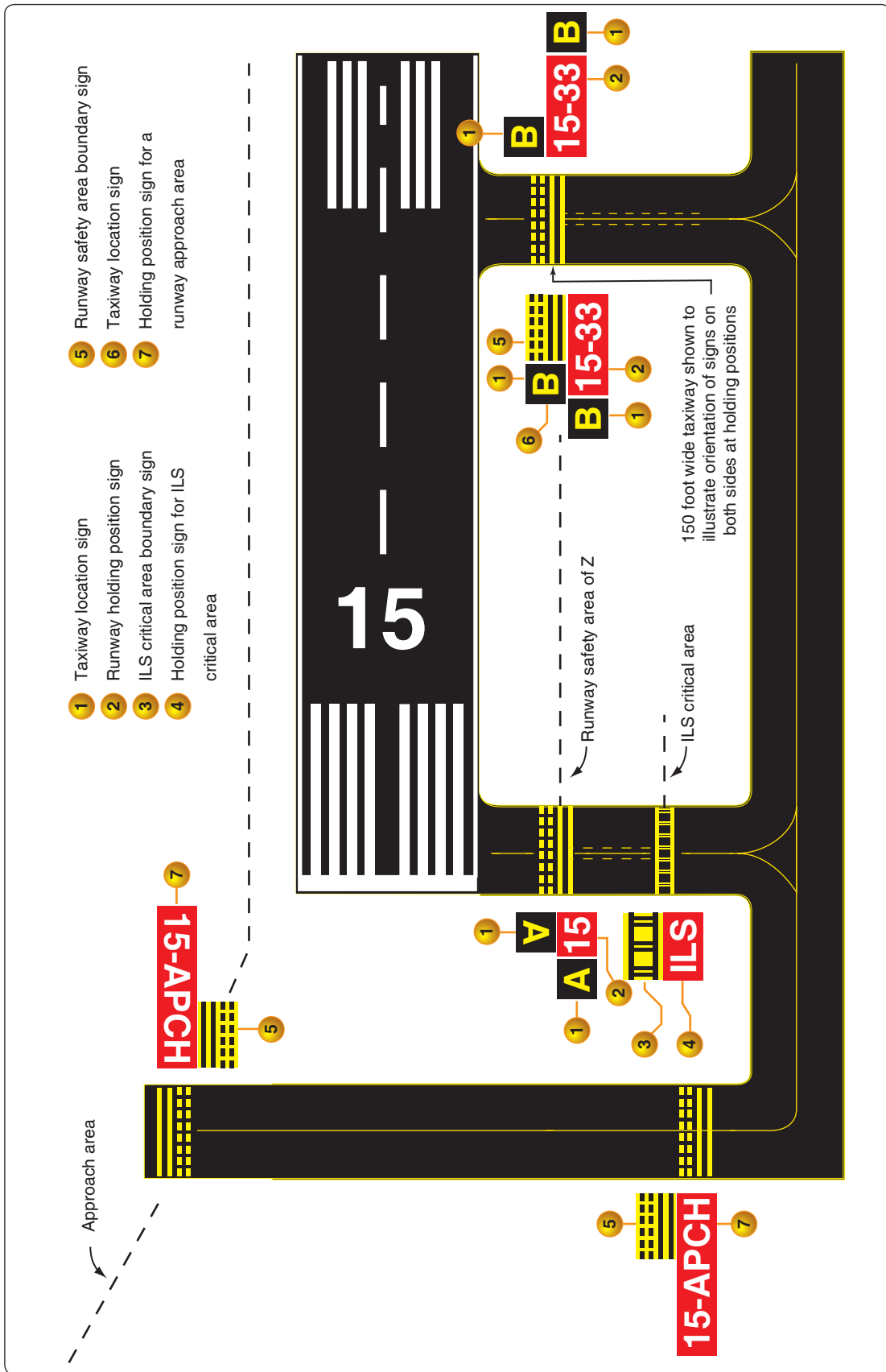

FIGURE 94.—Application Examples for Holding Positions.

FREQ	N.M.	KNOTS	MIN
115.0	60	180	20.0

NAV - 1



NAV - 2



FIGURE 95.—No. 1 and No. 2 NAV Presentation.

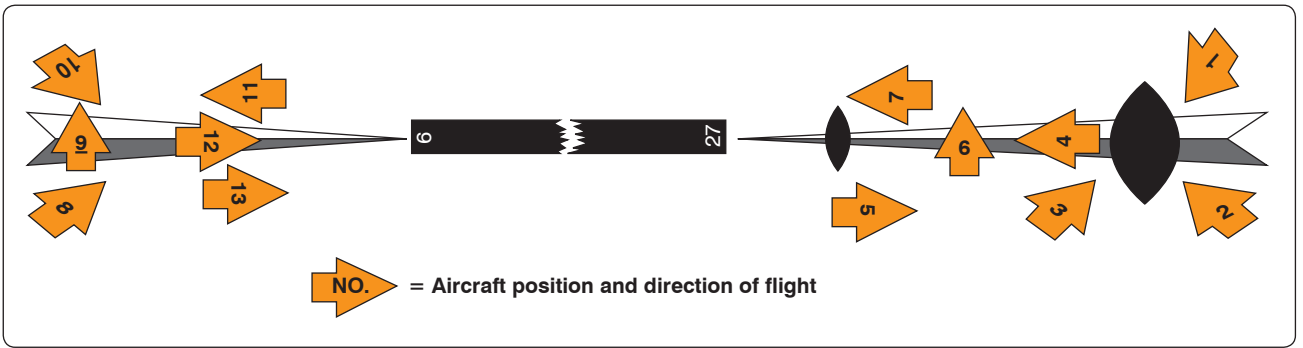

FIGURE 96.—Aircraft Position and Direction of Flight.



FIGURE 97.—HSI Presentation.

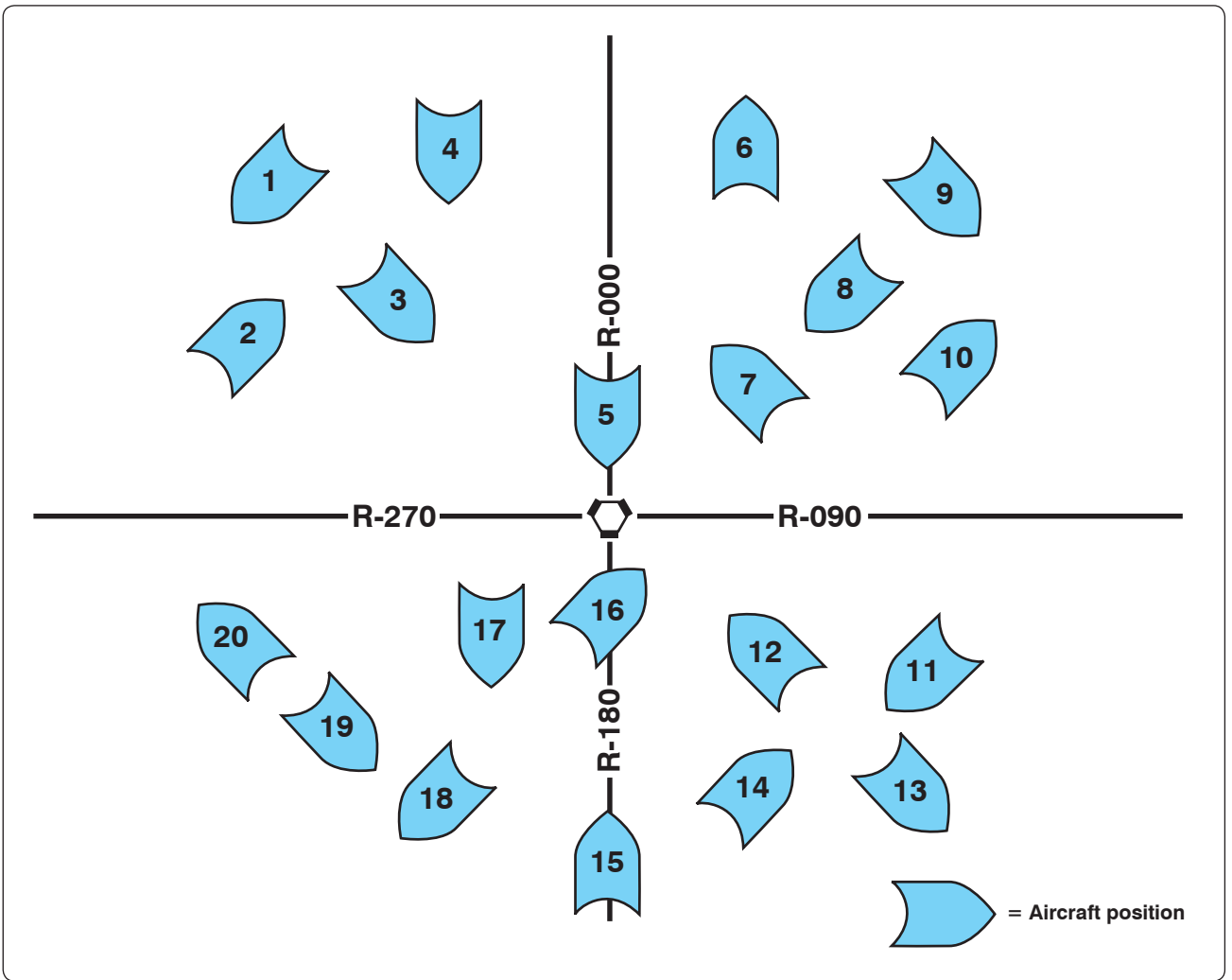

FIGURE 98.—Aircraft Position.



FIGURE 99.—HSI Presentation.

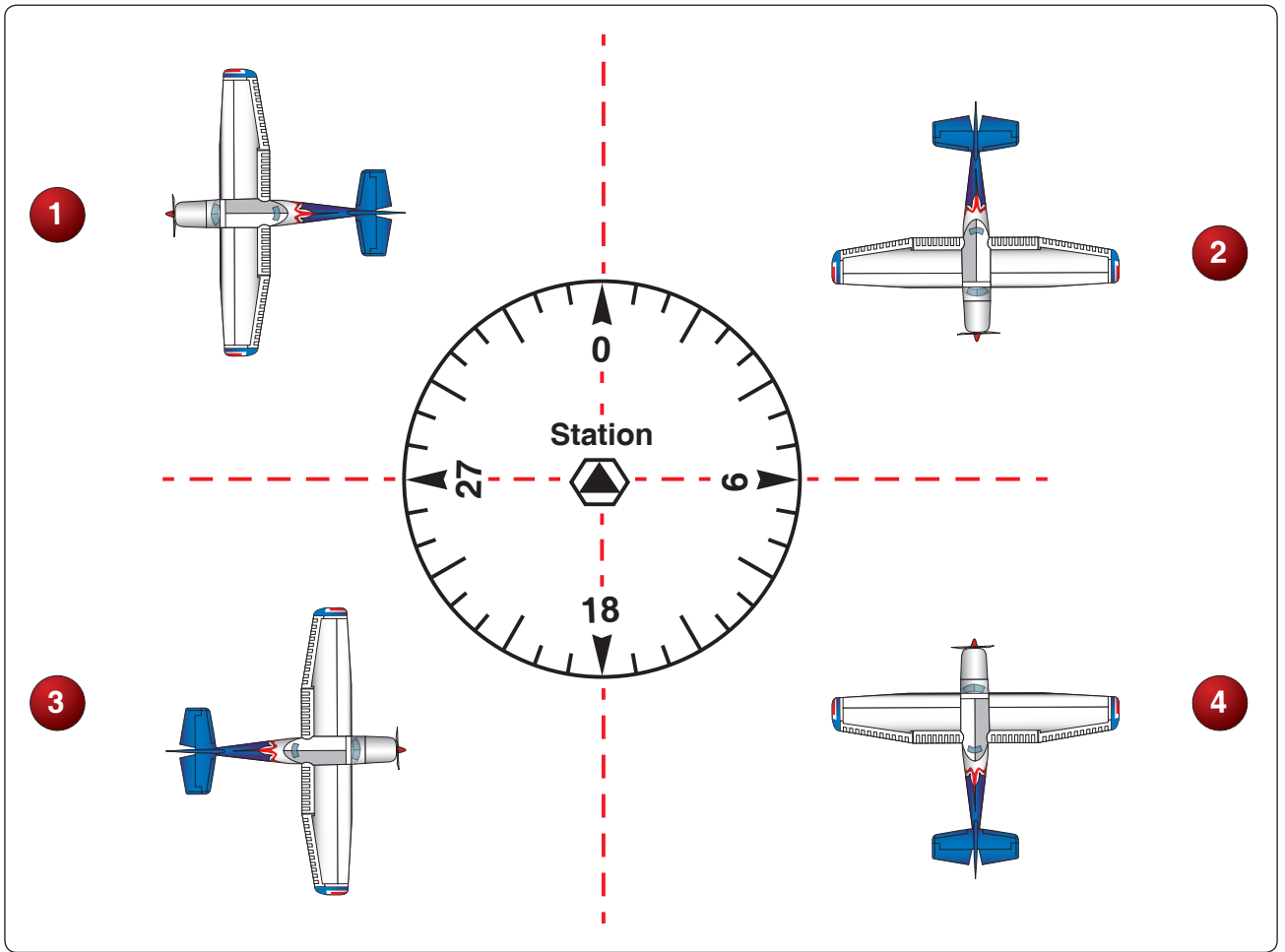

FIGURE 106.—Aircraft Location Relative to VOR.



FIGURE 109.—CDI Direction from VORTAC.





FIGURE 110.—CDI Direction from VORTAC.



FIGURE 111.—CDI Direction from VORTAC.

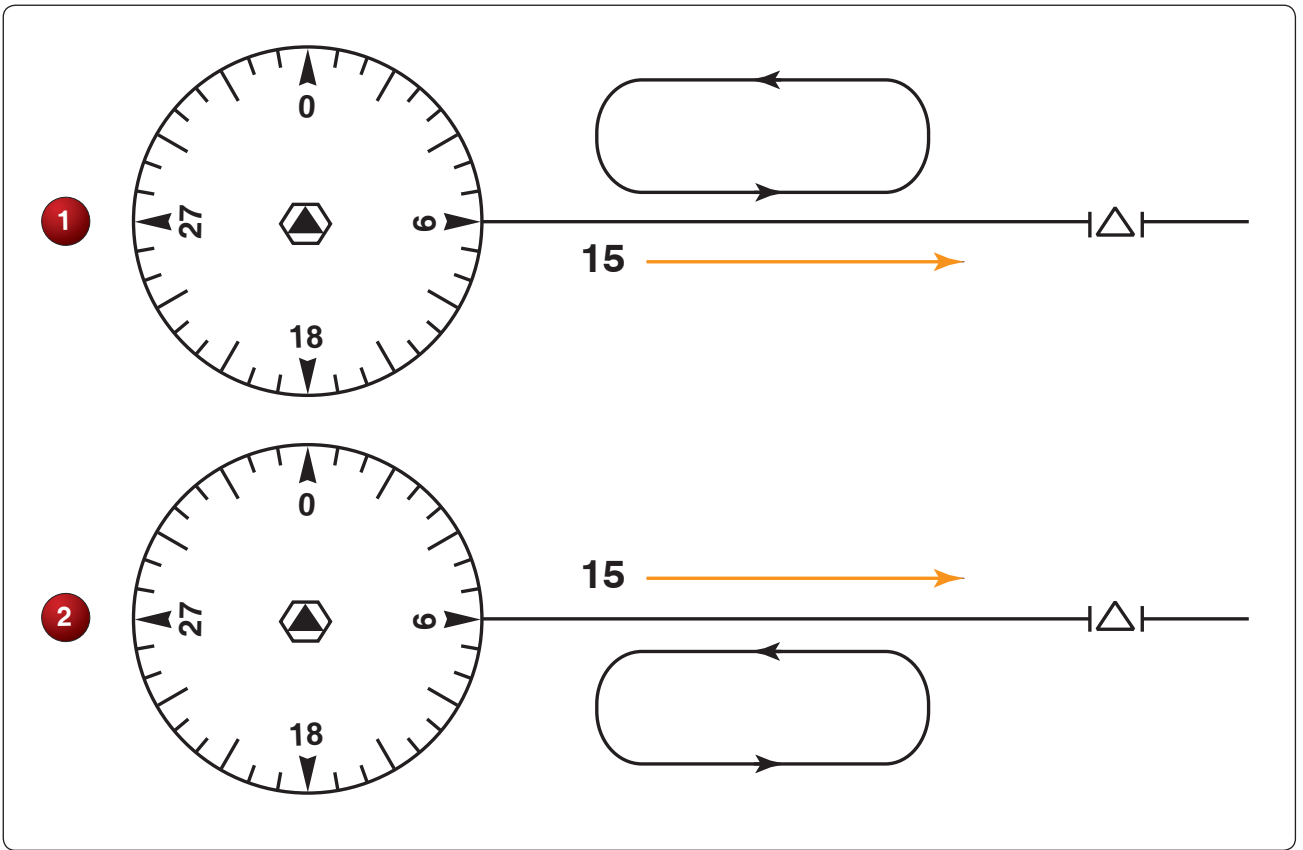

FIGURE 112.—Holding Entry Procedure.



FIGURE 113.—Aircraft Course and DME Indicator.



FIGURE 114.—Aircraft Course and DME Indicator.

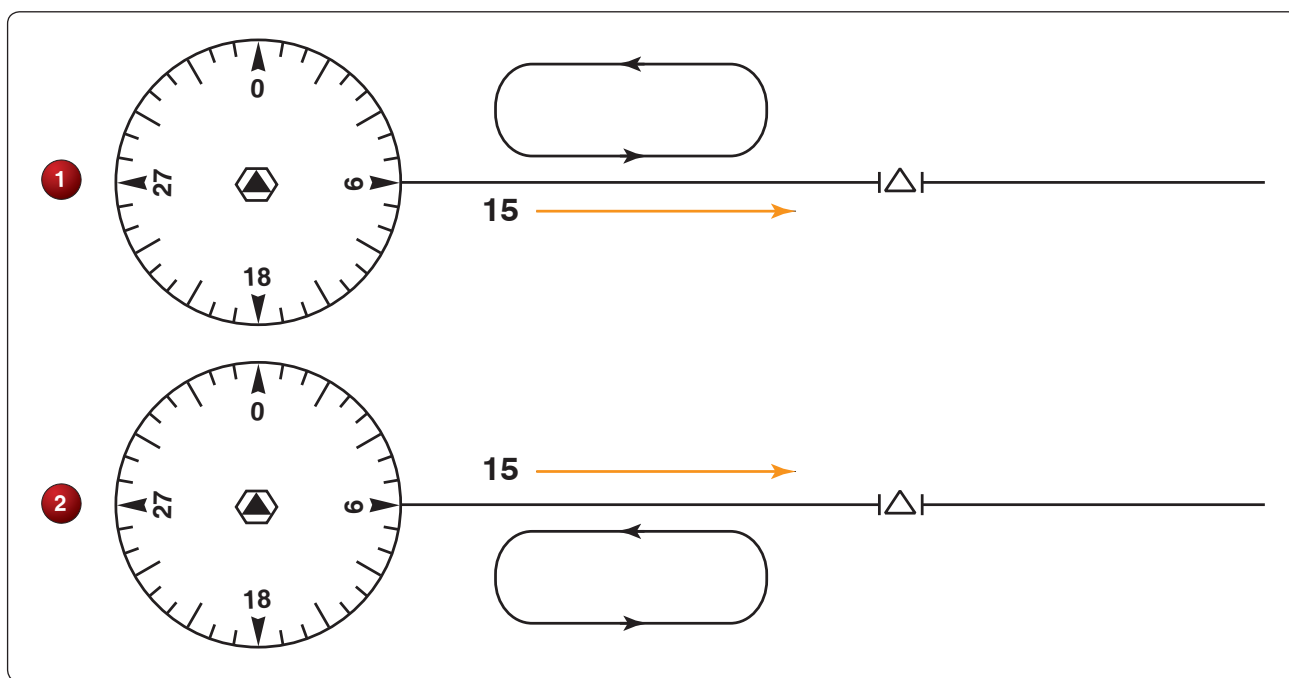

FIGURE 115.—DME Fix with Holding Pattern.

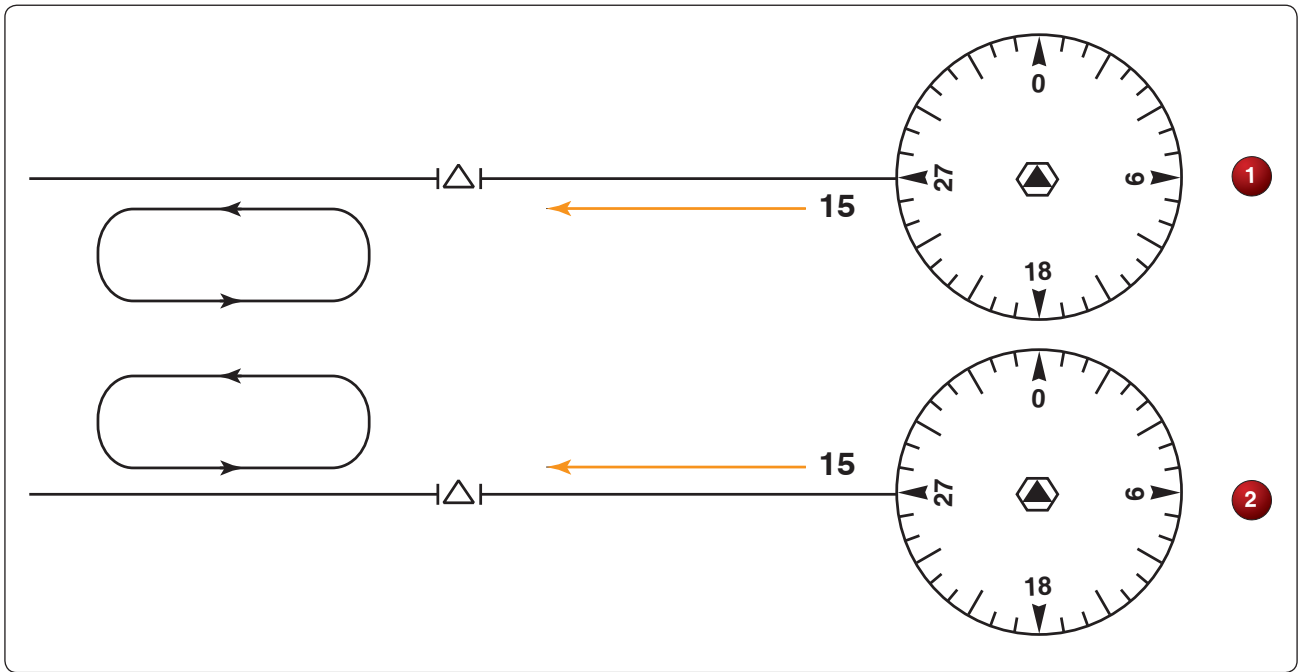

FIGURE 116.—Holding Entry Procedure.

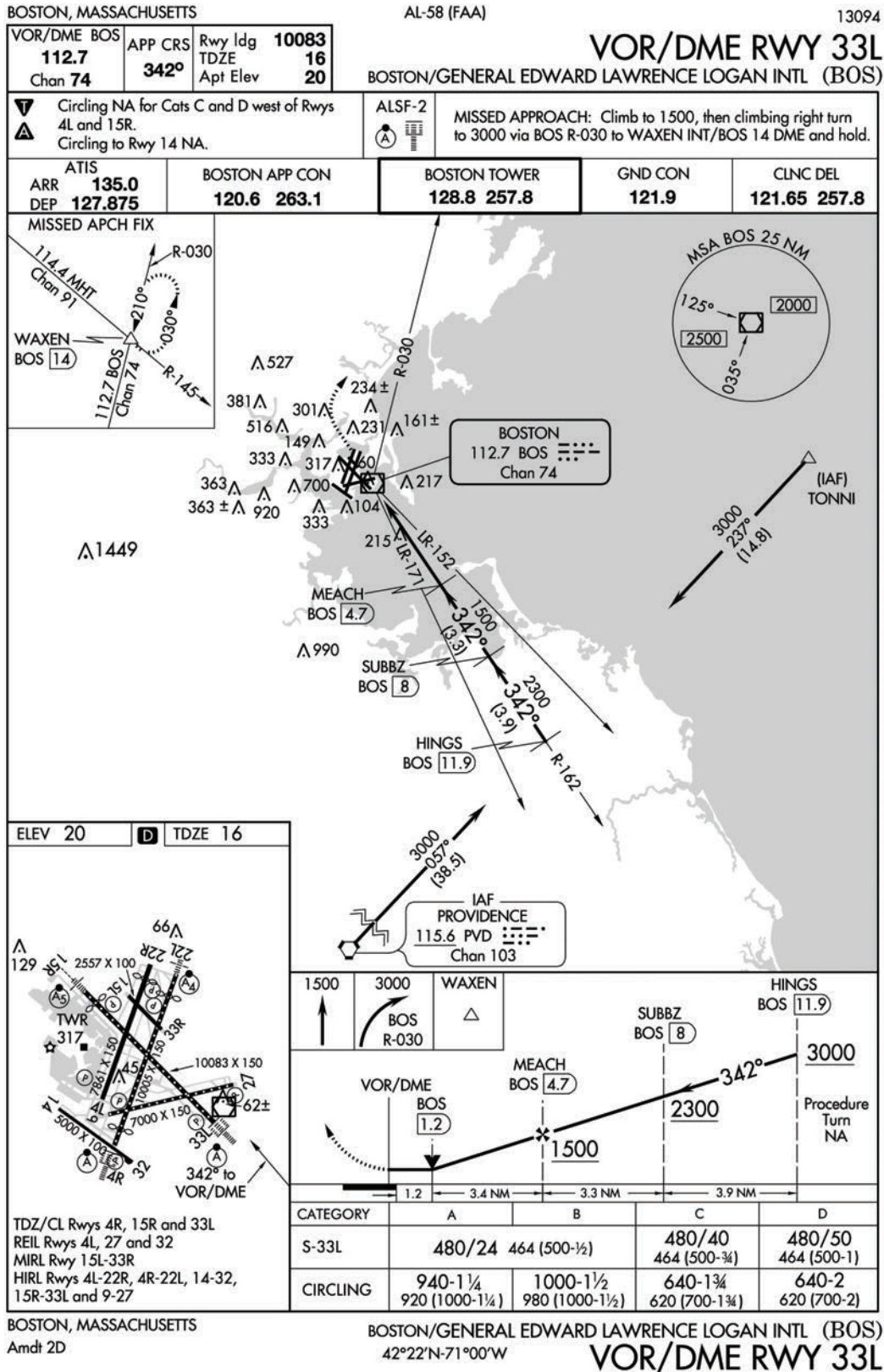

FIGURE 131.—VOR/DME RWY 33L.



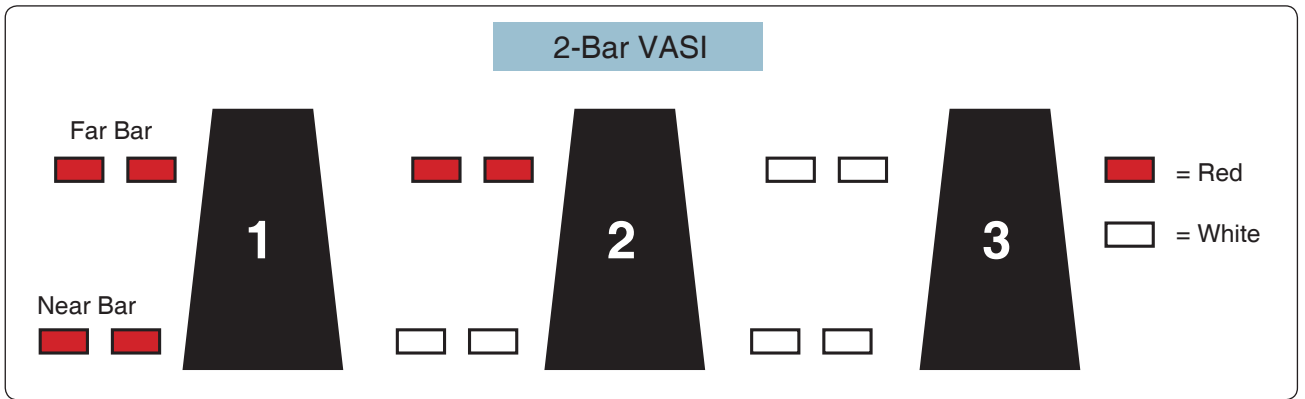

FIGURE 134.—2-BAR VASI.

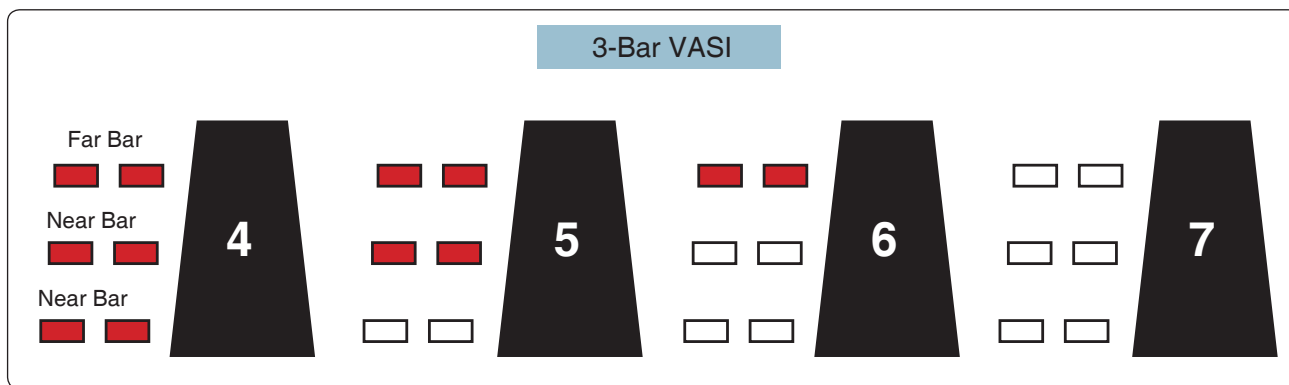

FIGURE 135.—3-BAR VASI.

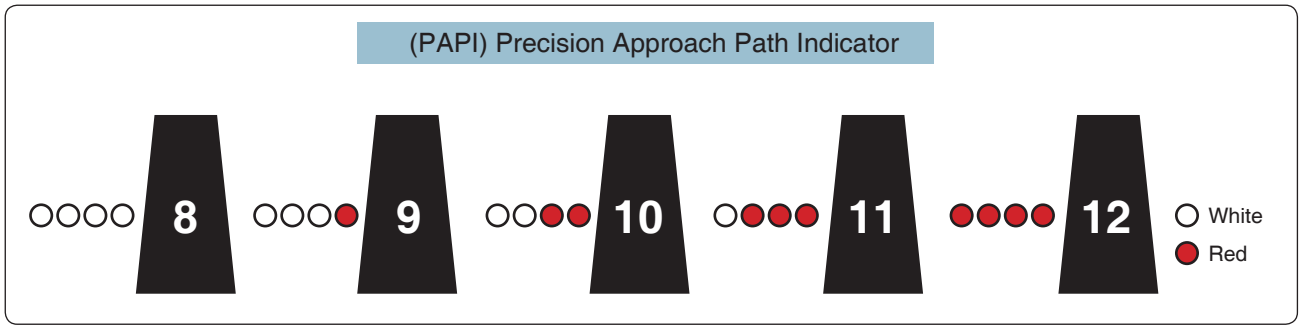

FIGURE 136.—Precision Approach Path Indicator (PAPI).

Appendix 2

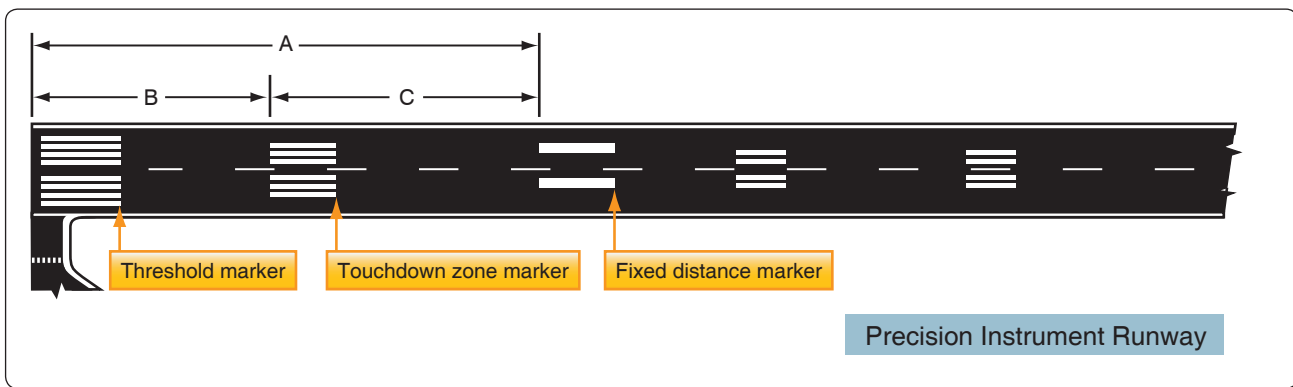

FIGURE 137.—Precision Instrument Runway.

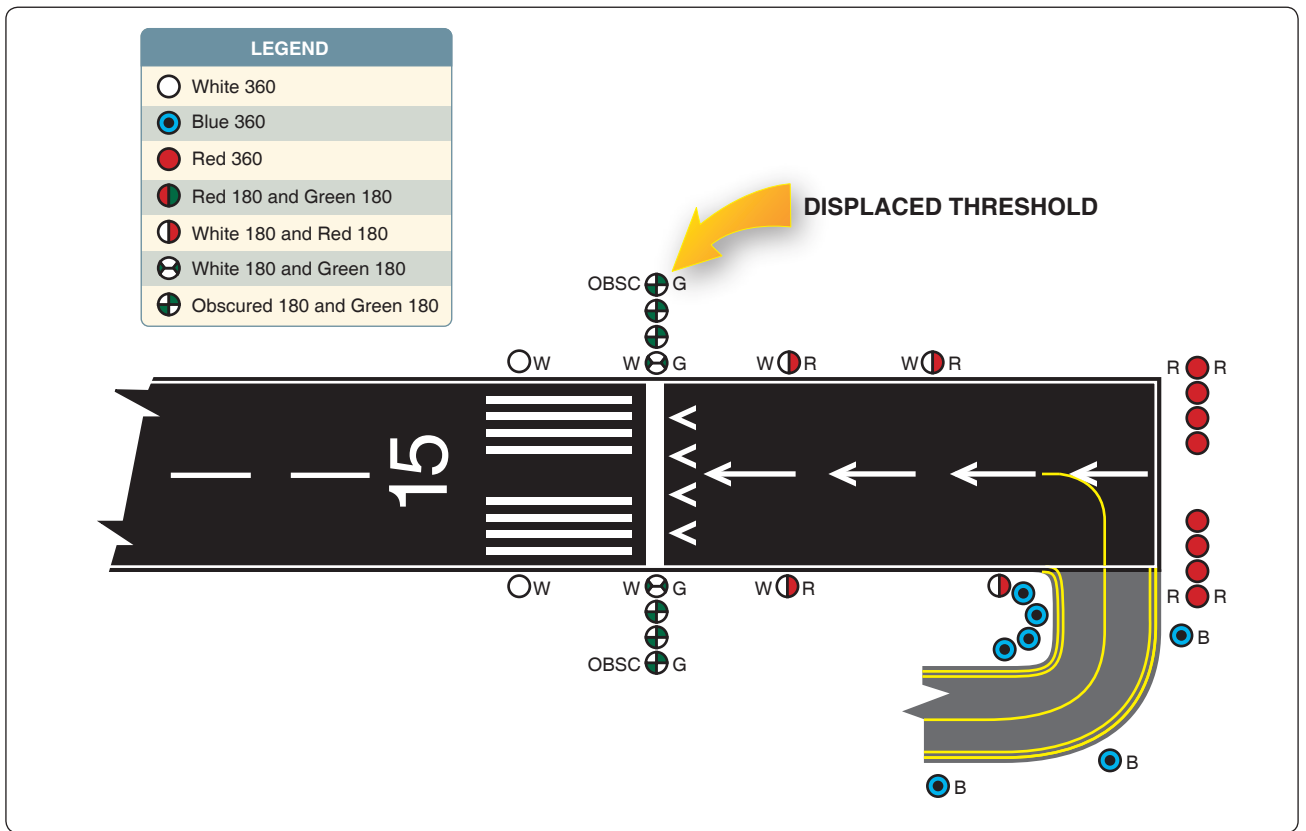

FIGURE 138.—Runway Legend.

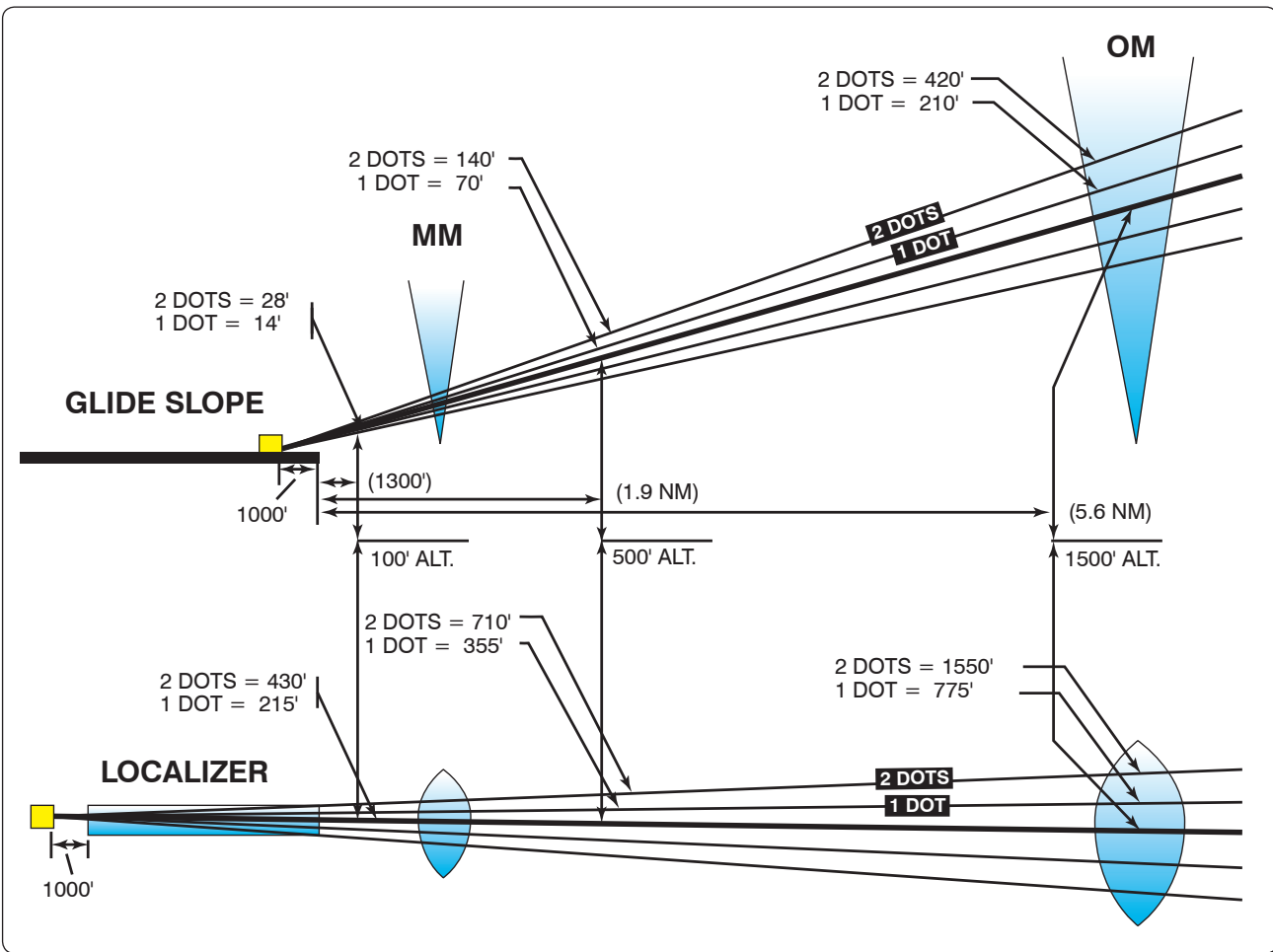

FIGURE 139.—Glide Slope and Localizer Illustration.



FIGURE 140.—OBS, ILS, and GS Displacement.



FIGURE 141.—OBS, ILS, and GS Displacement.





FIGURE 142.—OBS, ILS, and GS Displacement.



FIGURE 144.—Turn-and-Slip indicator.



FIGURE 145.—Instrument Sequence (Unusual Attitude).



FIGURE 146.—Instrument Sequence (System Failed).



FIGURE 147.—Instrument Sequence (Unusual Attitude).



FIGURE 148.—Instrument Interpretation (System Malfunction).



FIGURE 149.—Instrument Interpretation (System Malfunction).



FIGURE 150.—Instrument Interpretation (Instrument Malfunction).





FIGURE 151.—Instrument Interpretation (Instrument Malfunction).

(JNC6.JNC) 12320

SL-634 (FAA)

GRAND JUNCTION RGNL (GJT)  
GRAND JUNCTION, COLORADO

# GRAND JUNCTION SIX DEPARTURE

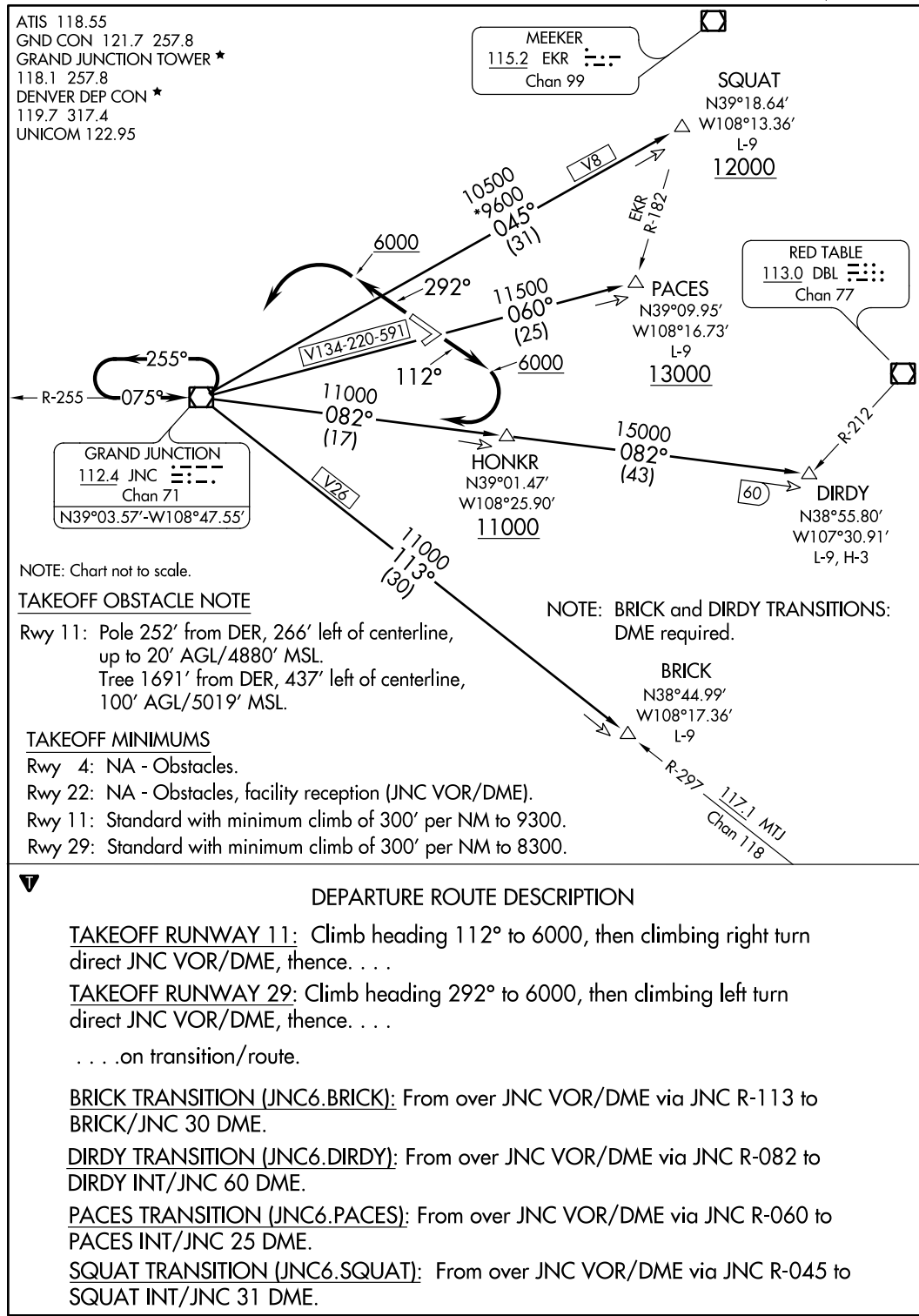

GRAND JUNCTION SIX DEPARTURE  
(JNC6.JNC) 12320

GRAND JUNCTION, COLORADO  
GRAND JUNCTION RGNL (GJT)

FIGURE 155.—Grand Junction Six Departure (JNC6.JNC).

## HOT SPOTS

An "airport surface hot spot" is a location on an aerodrome movement area with a history or potential risk of collision or runway incursion, and where heightened attention by pilots/drivers is necessary.

A "hot spot" is a runway safety related problem area on an airport that presents increased risk during surface operations. Typically it is a complex or confusing taxiway/taxiway or taxiway/runway intersection. The area of increased risk has either a history of or potential for runway incursions or surface incidents, due to a variety of causes, such as but not limited to: airport layout, traffic flow, airport marking, signage and lighting, situational awareness, and training. Hot spots are depicted on airport diagrams as open circles or polygons designated as "HS 1", "HS 2", etc. and tabulated in the list below with a brief description of each hot spot. Hot spots will remain charted on airport diagrams until such time the increased risk has been reduced or eliminated.

CITY/AIRPORT	HOT SPOT	DESCRIPTION*
ALAMOGORDO, NM HOLLOMAN AFB (HMN)	HS1	Twy R, Twy G, and Twy L have multiple hold lines for Rwy 07-25 and Rwy 04-22. Contact tower if confused or lost.
	HS2	Hold line on Twy/EOR A and Twy/EOR H have multiple POV access roads, possibility of high vehicle traffic.
	HS3	Hold line on Twy/EOR B and Twy C for Rwy 07-25 have multiple POV access roads, possibility of high vehicle traffic.
	HS4	Multiple hold lines at intersecting rwys. Landing/departing aircraft disregard hold lines, taxiing aircraft contact tower prior to crossing hold lines.
	HS5	Multiple hold lines where rwys intersect. Hold line also at Twy D. Contact tower if confused or lost.
	HS6	POV crossing controlled by tower. Hold line located on each side of Rwy 07-25. Possibility of high vehicular traffic.
ALBUQUERQUE, NM ALBUQUERQUE INTL SUNPORT (ABQ)	HS 1	Hold Position Marking on Twy E1 for Rwy 08 and Rwy 12.
	HS 2	Twy G1 from Cutter Aviation ramp and Rwy 12-30.
	HS 3	Complex int at Twy F, Twy C, Twy G. Twy G and Rwy 03-21
ASPEN, CO ASPEN-PITKIN COUNTY / SARDY FIELD (ASE)	HS 1	Twy A2. Short taxi distance from ramp to rwy.
	HS 2	Twy A3. Short taxi distance from ramp to rwy.
	HS 3	Twy A4. Short taxi distance from ramp to rwy.
COLORADO SPRINGS, CO CITY OF COLORADO SPRINGS (COS)	HS 1	The apch ends of Rwy 13 and Rwy 17R; and Twy A1.
	HS 2	Twy A4 and Twy G at Rwy 17R-35L.
	HS 3	Int of Twy E4, Twy G, Twy H and Twy E.
	HS 4	Apch ends of Rwy 35R and Rwy 35L.
DENVER, CO CENTENNIAL (APA)	HS 1	Rwy 17L at Twy A1.
	HS 2	Twy A, Twy A8, Twy A9 and Twy C1 congested INT.
	HS 3	Twy C1 and Twy D1 close proximity to Rwy 10.
DENVER, CO DENVER INTL (DEN)	HS 1	Rwy 35L hold signs may not be visible from Twy SC or Twy A until entering Twy M, pilots sometimes enter Rwy 35L without authorization.
	HS 2	Rwy 17R Apch Hold Position.
DENVER, CO ROCKY MOUNTAIN METROPOLITAN (BJC)	HS 1	Frequent helicopter operations.
	HS 2	Multiple hold lines in close proximity. Hold line on Twy B south of Rwy 11R-29L is prior to Twy D.
EAGLE, CO EAGLE COUNTY RGNL (EGE)	HS 1	High density parking area.
GRAND JUNCTION, CO GRAND JUNCTION RGNL (GJT)	HS 1	Rwy 22 and Rwy 29 close proximity, wrong rwy departure risk.

FIGURE 156.—Grand Junction Hot Spots.

GRAND JUNCTION, COLORADO

AL-634 (FAA)

13150

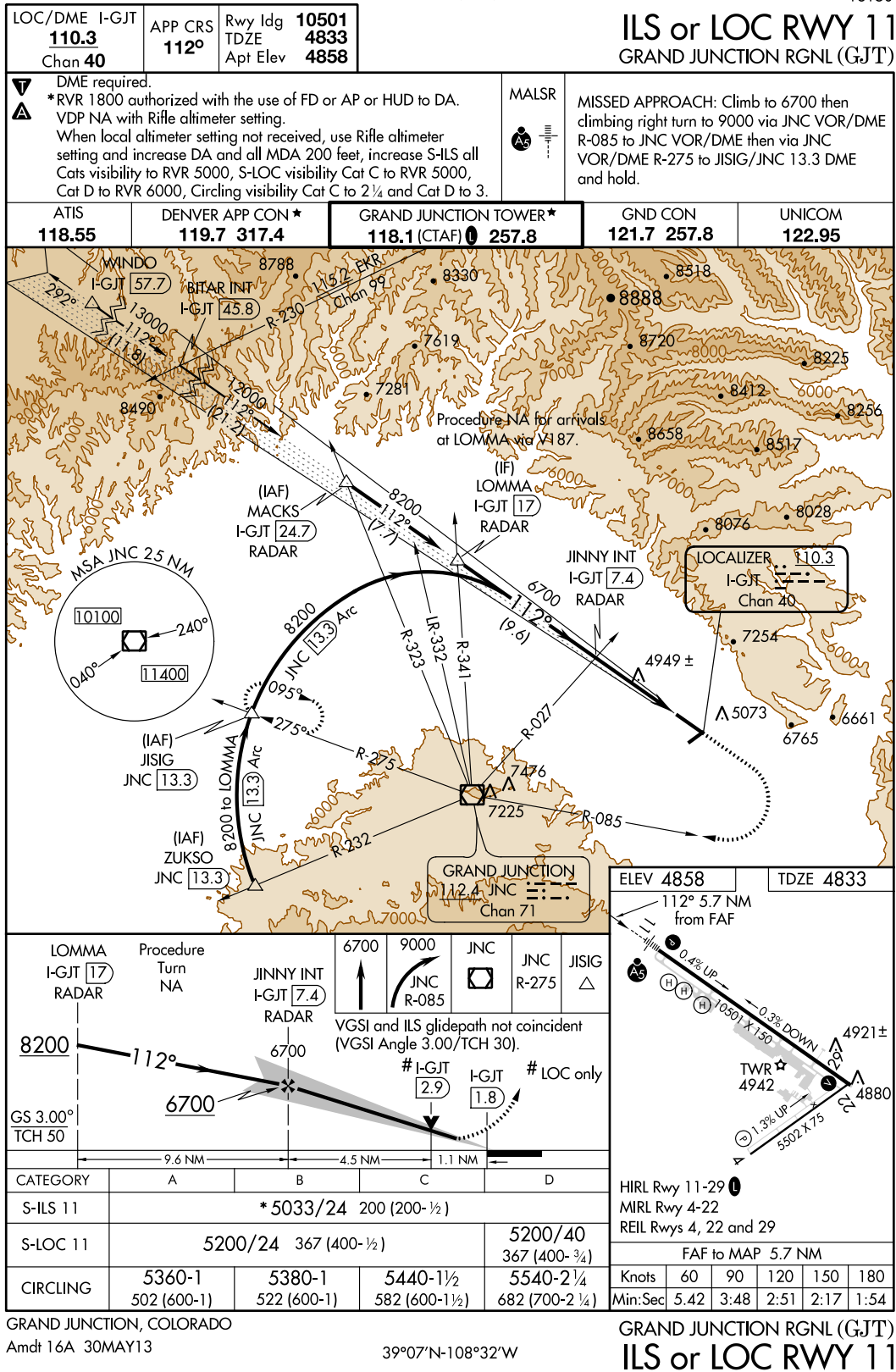

GRAND JUNCTION, COLORADO  
 Amdt 16A 30MAY13

39°07'N-108°32'W

GRAND JUNCTION RGNL (GJT)  
**ILS or LOC RWY 11**

FIGURE 157.—ILS RWY 11 (GJT).

GRAND JUNCTION, COLORADO

AL-634 (FAA)

13150

APP CRS <b>297°</b>	Rwy Idg TDZE Apt Elev	<b>10501</b> <b>4858</b> <b>4858</b>	<b>RNAV (GPS) RWY 29</b> GRAND JUNCTION RGNL (GJT)
DME/DME RNP-0.3 NA.		MISSED APPROACH: Climb to 10000 direct to LOMMA WP and hold.	

ATIS <b>118.55</b>	DENVER APP CON ★ <b>119.7 317.4</b>	GRAND JUNCTION TOWER ★ <b>118.1 (CTAF) 257.8</b>	GND CON <b>121.7 257.8</b>	UNICOM <b>122.95</b>
-----------------------	--	---	-------------------------------	-------------------------

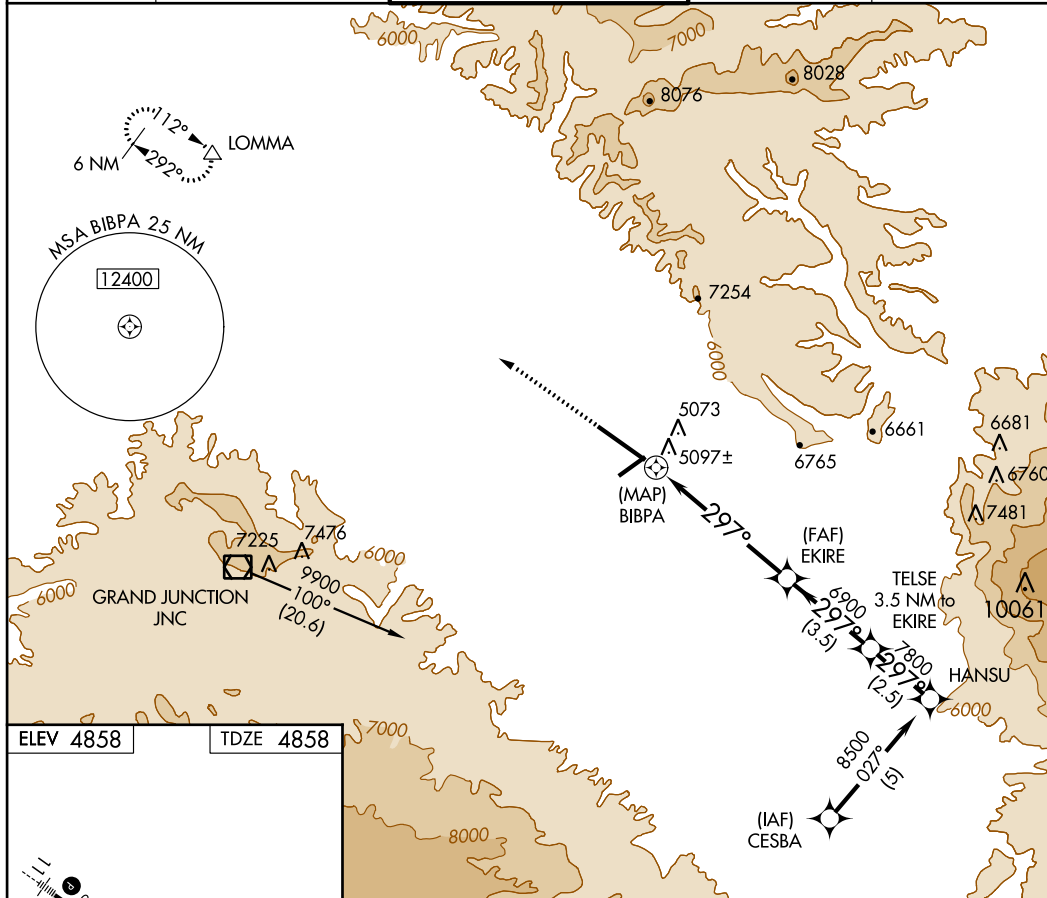

ELEV 4858 TDZE 4858

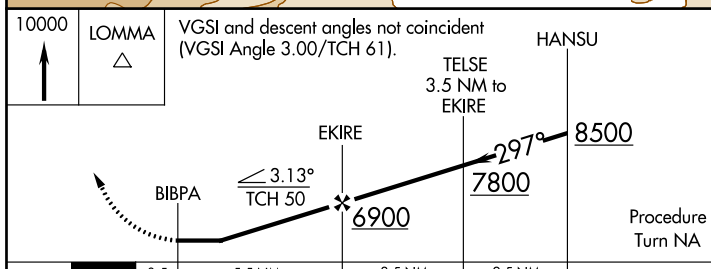
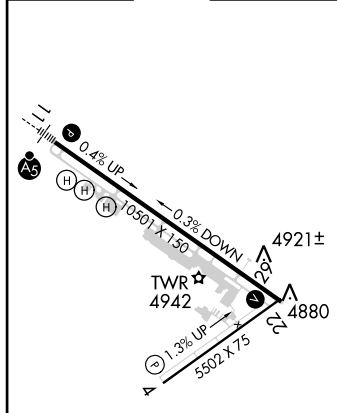

	LOMMA △	VGSIs and descent angles not coincident (VGSi Angle 3.00/TCH 61).		TELSE 3.5 NM to EKIRE	HANSU
					Procedure Turn NA
CATEGORY	A	B	C	D	
LNAV MDA	5340-1	482 (500-1)	5340-1¼ 482 (500-1¼)	5340-1½ 482 (500-1½)	
CIRCLING	5400-1	542 (600-1)	5540-2 682 (700-2)	5640-2½ 782 (800-2½)	

GRAND JUNCTION, COLORADO  
Amdt 1B 30MAY13

39°07'N-108°32'W

GRAND JUNCTION RGNL (GJT)  
**RNAV (GPS) RWY 29**

FIGURE 158.—ILS RWY 11 (GJT).

Appendix 2

DURANGO, COLORADO

AL-480 (FAA)

LOC I-DRO <b>109.1</b>	APP CRS <b>027°</b>	Rwy Idg TDZE Apt Elev <b>9201</b> <b>6638</b> <b>6685</b>
---------------------------	------------------------	--

**ILS or LOC/DME RWY 3**  
DURANGO-LA PLATA COUNTY (DRO)

**▼** DME from DRO VOR/DME. Simultaneous reception of I-DRO and DRO VOR/DME required.

MALSR MISSED APPROACH: Climb to 7500 then climbing right turn to 10000 via heading 140° and DRO VOR/DME R-120 to SOVDE/14 DME and hold. Continue climb-in-hold to 10000.

ASOS <b>120.625</b>	DENVER CENTER <b>118.575 348.7</b>	UNICOM <b>122.8 (CTAF) 0</b>
------------------------	---------------------------------------	---------------------------------

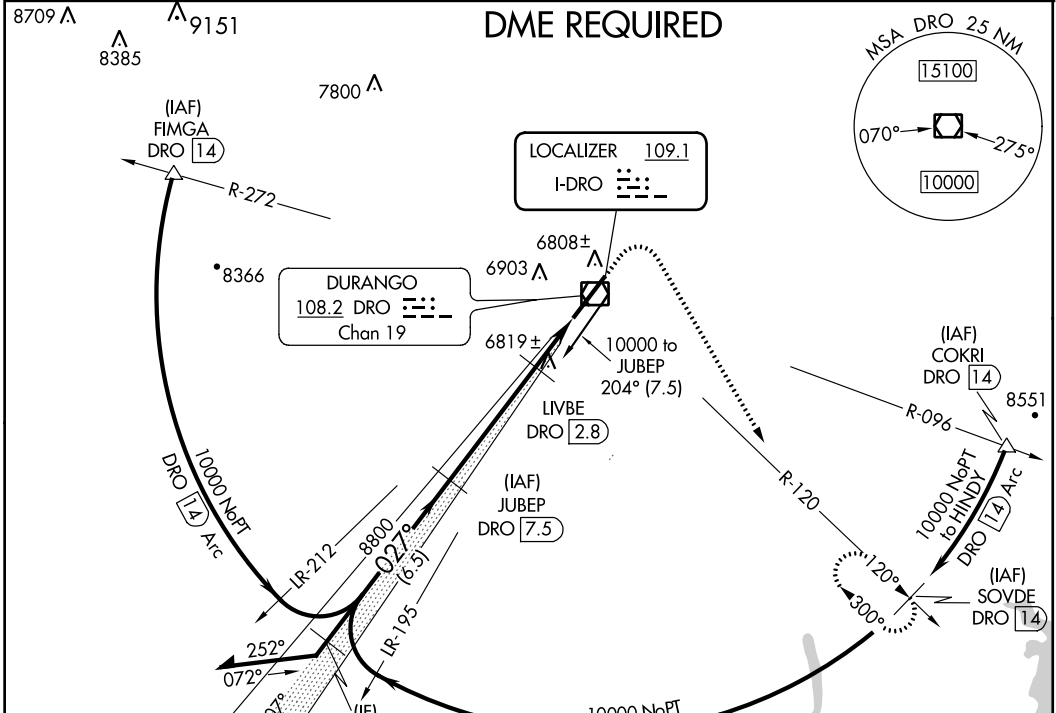

ELEV 6685	TDZE 6638
-----------	-----------

Procedure NA for arrivals at RSK VORTAC via airway radials 333 CW 072.

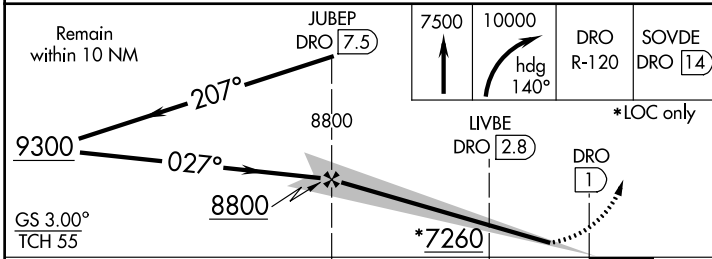

CATEGORY	A	B	C	D
S-ILS 3	6838-1/2 200 (200-1/2)			
S-LOC 3	7080-1/2 442 (400-1/2)	7080-3/4 442 (400-3/4)	7220-1 7260-2	7080-1 442 (400-1)
CIRCLING	7180-1 495 (500-1)	7200-1 515 (600-1)	535 (600-1 1/2)	575 (600-2)

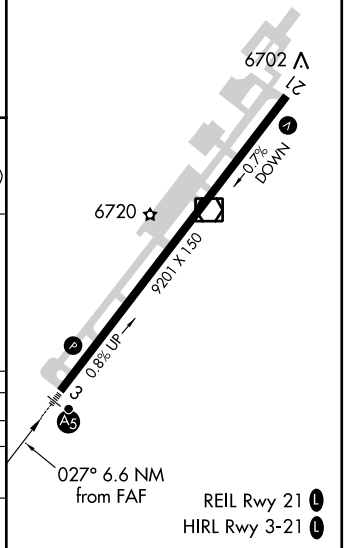

DURANGO, COLORADO  
Amdt 4 12096

37°09'N-107°45'W

DURANGO-LA PLATA COUNTY (DRO)  
**ILS or LOC/DME RWY 3**

FIGURE 159.—ILS/DME RWY 3 (DRO).

EUGENE, OREGON

AL-140 (FAA)

13290

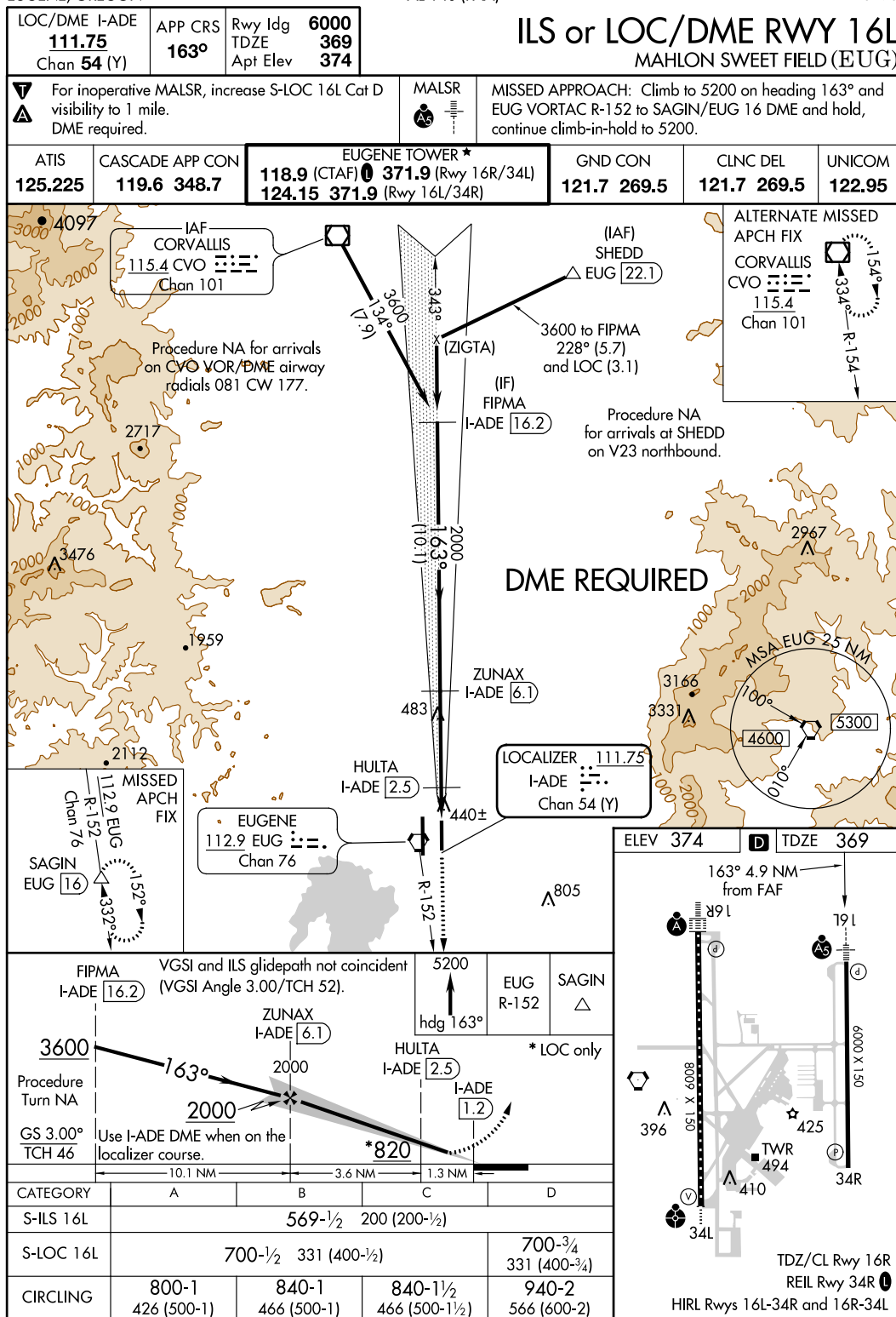

EUGENE, OREGON

MAHLON SWEET FIELD (EUG)

Amdt 1 23SEP10

44°07'N-123°13'W

ILS or LOC/DME RWY 16L

FIGURE 160.—ILS or LOC/DME RWY 16L (EUG).

EUGENE, OREGON

AL-140 (FAA)

13290

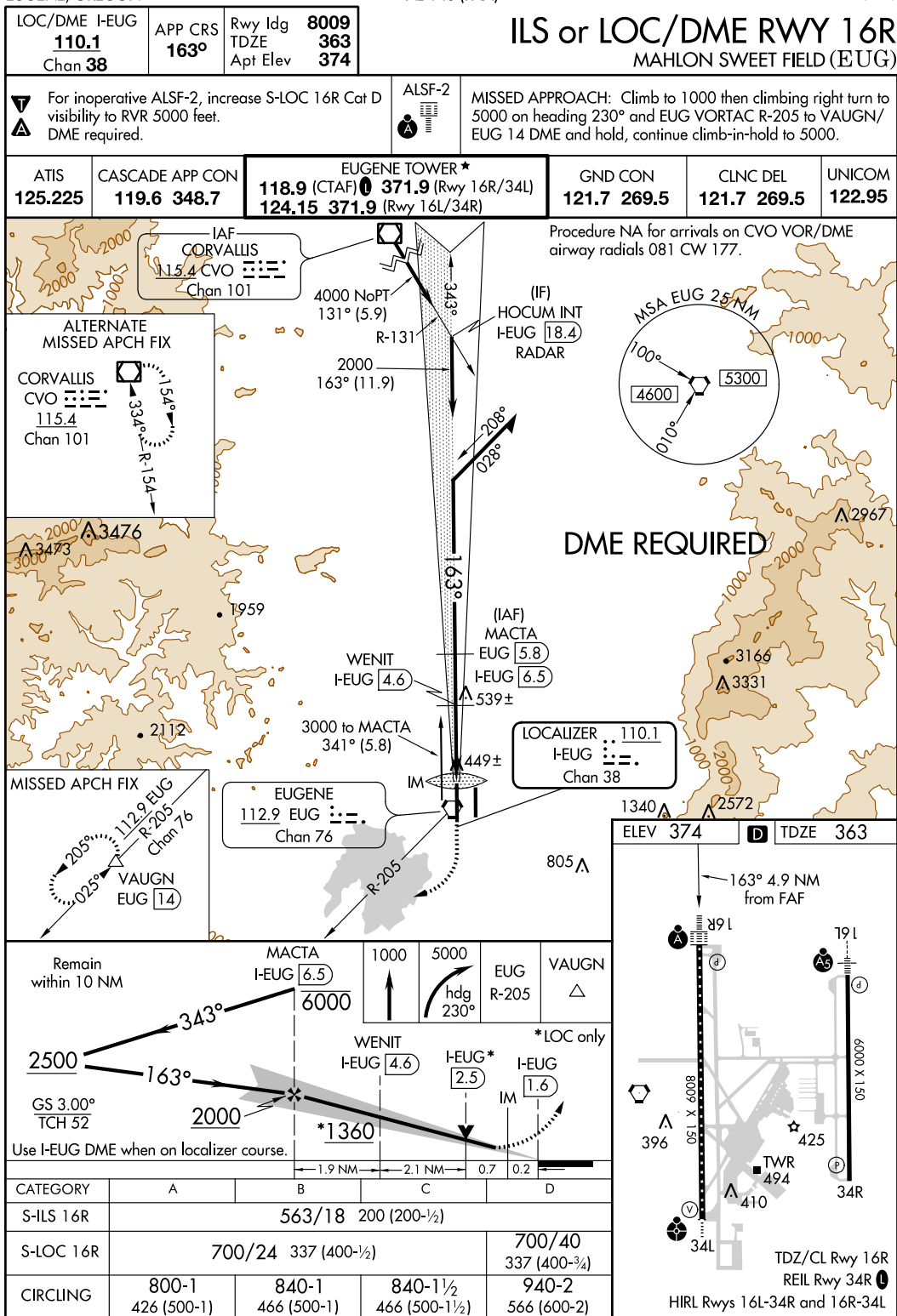

EUGENE, OREGON

Amdt 36 23SEP10

44°07'N-123°13'W

MAHLON SWEET FIELD (EUG)

**ILS or LOC/DME RWY 16R**

FIGURE 161.—ILS or LOC/DME RWY 16R (EUG).



**EUGENE**

**MAHLON SWEET FLD (EUG)** 7 NW UTC-8(-7DT) N44°07.48' W123°12.72'  
 374 B S4 FUEL 100LL, JET A OX 1, 2, 3, 4 TPA-1174(800) Class I, ARFF Index B  
 NOTAM FILE EUG

**KLAMATH FALLS**  
 H-1B, L-1B  
 IAP AD

**RWY 16R-34L:** H8009X150 (ASPH-GRVD) S-75, D-200, 2D-400  
 HIRL CL  
**RWY 16R:** ALSF2. TDZL. PAPI(P4L)—GA 3.0° TCH 50'.  
**RWY 34L:** ODALS. VASI(V4L)—GA 3.0° TCH 53'.  
**RWY 16L-34R:** H6000X150 (ASPH-GRVD) S-105, D-175, 2D-240  
 HIRL  
**RWY 16L:** MALS. PAPI(P4L)—GA 3.0° TCH 52'.  
**RWY 34R:** REIL. PAPI(P4L)—GA 3.0° TCH 50'.

**RUNWAY DECLARED DISTANCE INFORMATION**

**RWY 16L:**TORA-6000 TODA-6000 ASDA-6000 LDA-6000  
**RWY 16R:**TORA-8009 TODA-8009 ASDA-8009 LDA-8009  
**RWY 34L:**TORA-8009 TODA-8009 ASDA-8009 LDA-8009  
**RWY 34R:**TORA-6000 TODA-6000 ASDA-6000 LDA-6000

**AIRPORT REMARKS:** Attended continuously. Migratory waterfowl and other birds on and in/ov arpt. PPR for unscheduled air carrier ops with more than 30 passenger seats call 541-682-5430. ARFF svcs unavailable 0000-0500 local except PPR 541-682-5430. No access to Rwy 34L byd Twy A9. Helicopters ldg and departing avoid overflying the airline passenger terminal and ramp located E of Rwy 16R-34L. Helipad west of Rwy 16R restricted, PPR phone 541-682-5430. Twys H and K unavailable to acct 21,000 pounds single weight and 40,000 pounds dual gross weight. Terminal apron closed to acct except scheduled air carriers and flights with prior permission. PAPI Rwy 16R and Rwy 16L and 34R and VASI Rwy 34L opr 24 hrs. When twr clsd HIRL Rwy 16L-34R and Rwy 16R-34L preset medium ints. When twr clsd ACTIVATE ALSF2 Rwy 16R, ODALS Rwy 34L MALS Rwy 16L and REIL Rwy 34R—CTAF.

**WEATHER DATA SOURCES:** ASOS (541) 461-3114 HIWAS 112.9 EUG.

**COMMUNICATIONS:** CTAF 118.9 ATIS 125.225 541-607-4699 UNICOM 122.95

**EUGENE RCO** 122.3 (MC MINNVILLE RADIO)

Ⓡ **CASCADE APP/DEP CON** 119.6 (340°-159°) 120.25 (160°-339°) (1400-0730Z‡)

Ⓡ **SEATTLE CENTER APP/DEP CON** 125.8 (0730-1400Z‡)

**EUGENE TOWER** 118.9 (Rwy 16R-34L) 124.15 (Rwy 16L-34R) (1400-0730Z‡) **GND CON** 121.7 **CLNC DEL** 121.7

**AIRSPACE:** CLASS D svc 1400-0730Z‡ other times CLASS E.

**RADIO AIDS TO NAVIGATION:** NOTAM FILE EUG.

**EUGENE (H) VORTACW** 112.9 EUG Chan 76 N44°07.25' W123°13.37' at fld. 364/20E. HIWAS.

**ILS/DME** 111.75 I-ADE Chan 54(Y) Rwy 16L. Class IE.

**ILS/DME** 110.1 I-EUG Chan 38 Rwy 16R. Class IIIE. Unmonitored when ATCT clsd.

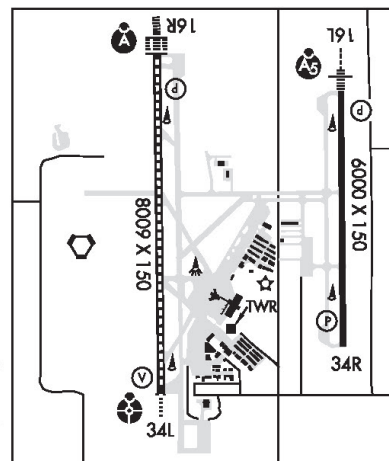

**FLORENCE**

**FLORENCE MUNI (6S2)** 1 N UTC-8(-7DT) N43°58.97' W124°06.68'  
 51 B FUEL 100LL, JET A TPA-1051(1000) NOTAM FILE MMV

**KLAMATH FALLS**  
 L-1A

**RWY 15-33:** H3000X60 (ASPH) S-12.5 MIRL 0.4% up NW  
**RWY 15:** Hill. Rgt tfc.  
**RWY 33:** PAPI(P2L)—GA 3.0° TCH 40'. Trees.

**AIRPORT REMARKS:** Attended 1630-0030Z‡. Birds, deer and wildlife on and in/ov arpt. ACTIVATE MIRL Rwy 15-33—CTAF. PAPI Rwy 33 opr 24 hrs.

**WEATHER DATA SOURCES:** AWOS-3 118.225 (541) 997-8664.

**COMMUNICATIONS:** CTAF/UNICOM 122.8

**RADIO AIDS TO NAVIGATION:** NOTAM FILE OTH.

**NORTH BEND (L) VORTACW** 112.1 OTH Chan 58 N43°24.93'

W124°10.11' 346° 34.1 NM to fld. 707/18E. HIWAS.

VORTAC unusable.

012°-087° byd 30 NM blo 5,000'

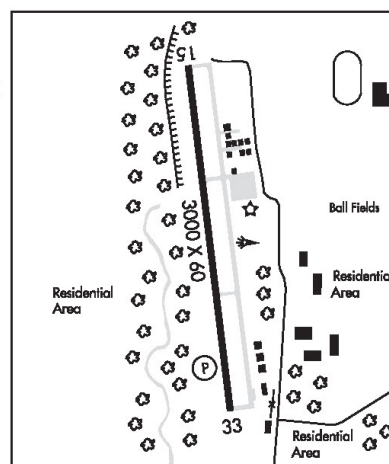

FIGURE 162.—Excerpt from Chart Supplement.

(GNATS6.GNATS) 13290  
**GNATS SIX DEPARTURE**

SL-251 (FAA)

ROGUE VALLEY INTL-MEDFORD (MFR)

MEDFORD, OREGON

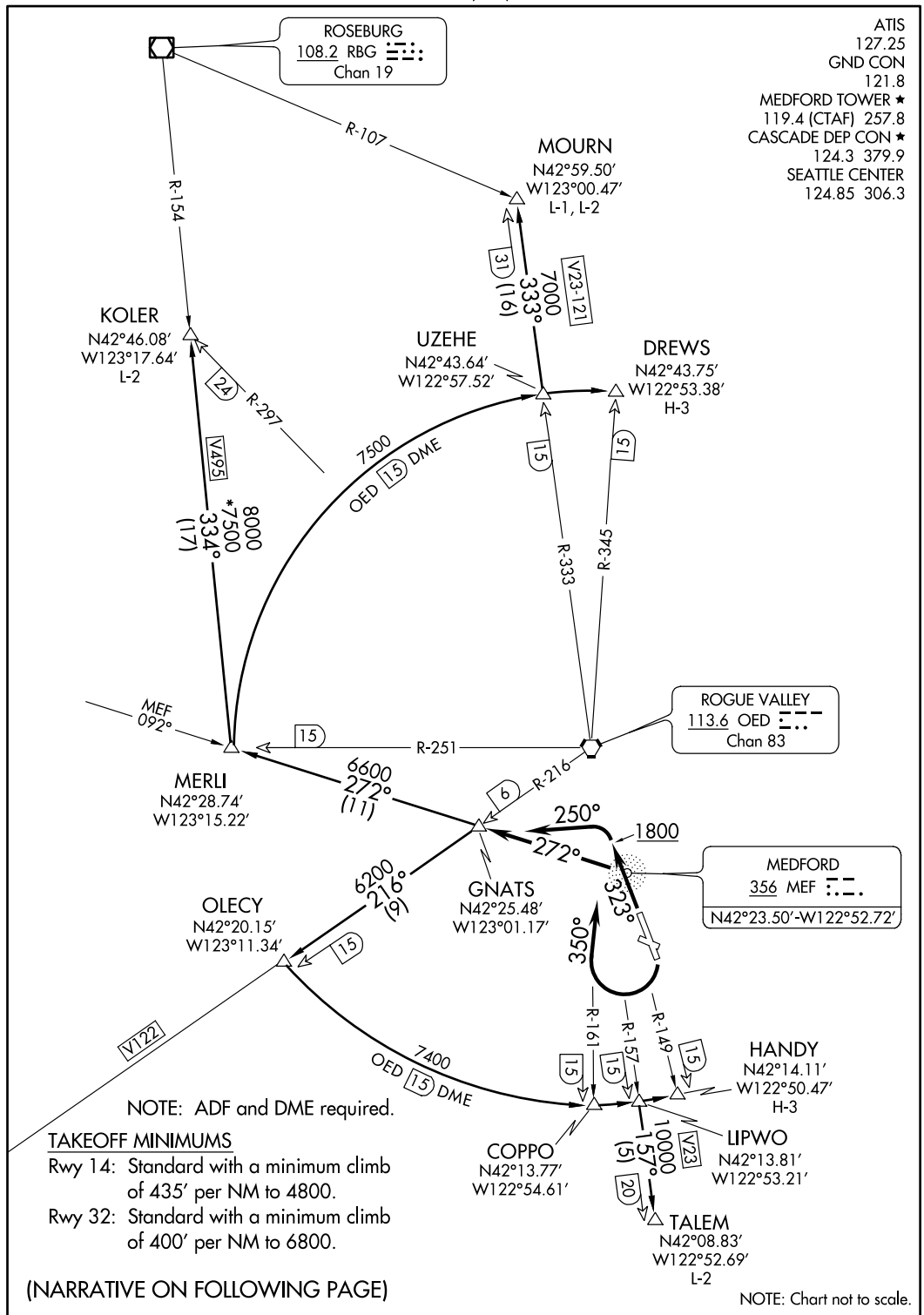

**GNATS SIX DEPARTURE**  
 (GNATS6.GNATS) 13290

MEDFORD, OREGON  
 ROGUE VALLEY INTL-MEDFORD (MFR)

FIGURE 163.—GNATS Six Departure (GNATS6.GNATS).

(GNATS6.GNATS) 13290  
GNATS SIX DEPARTURE

SL-251 (FAA)

ROGUE VALLEY INTL-MEDFORD (MFR)  
MEDFORD, OREGON



#### DEPARTURE ROUTE DESCRIPTION

TAKEOFF RUNWAY 14: Climbing right turn on heading 350° to intercept bearing 272° from MEF NDB to GNATS INT. Thence . . . .

TAKEOFF RUNWAY 32: Climb on heading 323° to 1800 then climbing left turn on heading 250° to intercept bearing 272° from MEF NDB to GNATS INT. Thence . . . .

. . . . via (transition) or (assigned route). Maintain 11000 or assigned lower altitude.

COPPO TRANSITION (GNATS6.COPPO): From over GNATS INT via OED VORTAC R-216 to OLECY DME, then via the OED VORTAC 15 DME Arc CCW to COPPO DME.

DREWS TRANSITION (GNATS6.DREWS): From over GNATS INT via MEF NDB 272° to MERLI INT, then via the OED VORTAC 15 DME Arc CW to DREWS DME.

HANDY TRANSITION (GNATS6.HANDY): From over GNATS INT via the OED VORTAC R-216 to OLECY DME, then via the OED VORTAC 15 DME Arc CCW to HANDY DME.

KOLER TRANSITION (GNATS6.KOLER): From over GNATS INT via MEF NDB 272° to MERLI INT, then via RBG VOR/DME R-154 to KOLER INT.

MOURN TRANSITION (GNATS6.MOURN): From over GNATS INT via MEF NDB 272° to MERLI INT, then via the OED VORTAC 15 DME Arc CW to UZEHE DME, then via OED VORTAC R-333 to MOURN INT.

TALEM TRANSITION (GNATS6.TALEM): From over GNATS INT via OED VORTAC R-216 to OLECY DME, then via the OED VORTAC 15 DME Arc CCW to LIPWO DME, then via OED VORTAC R-157 to TALEM DME.

GNATS SIX DEPARTURE  
(GNATS6.GNATS) 13290

MEDFORD, OREGON  
ROGUE VALLEY INTL-MEDFORD (MFR)

FIGURE 164.—GNATS Six Departure (GNATS6.GNATS).

**MEDFORD**

**ROGUE VALLEY INTL — MEDFORD** (MFR) 3 N UTC-8(-7DT) N42°22.45' W122°52.41'

**KLAMATH FALLS**  
H-3B, L-2I  
IAP AD

1335 B S4 FUEL 100LL, JET A OX 1, 3 TPA—See Remarks Class I, ARFF Index B  
NOTAM FILE MFR

**RWY 14-32:** H8800X150 (ASPH-GRVD) S-200, D-200, 2S-175, 2D-400 HIRL CL

**RWY 14:** MALSR. TDZL. PAPI(P4L)—GA 3.0° TCH 73'. 0.4% up.

**RWY 32:** REIL. PAPI(P4R)—GA 3.0° TCH 50'. 0.5% down.

**RUNWAY DECLARED DISTANCE INFORMATION**

**RWY 14:** TORA-8800 TODA-8800 ASDA-8800 LDA-8800

**RWY 32:** TORA-8800 TODA-8800 ASDA-8800 LDA-8800

**AIRPORT REMARKS:** Attended 1300-0800Z†. For fuel after hrs call 541-779-5451, or 541-842-2254. Bird haz large flocks of migratory waterfowl in vicinity Nov-May. Terminal apron clsd to acft exc scheduled air carrier and flts with prior permission. PPR for unscheduled ops with more than 30 passenger seats, call arpt ops 541-776-7228. Tran tie-downs avbl thru FBOs only. Rwy 32 preferred for tkfs and ldgs when twr clsd. TPA—2304(969) for propeller acft, 2804(1469) for turbo acft. PAPI Rwy 14 and VASI Rwy 32 on continuously. ACTIVATE HIRL Rwy 14-32, MALSR Rwy 14, REIL Rwy 32, TDZL Rwy 14, centerline lgts Rwy 14 and Rwy 32, and twy lgts—CTAF. Ldg fee applies to all corporate acft and all other acft with weight exceeding 12,500 lbs.

**WEATHER DATA SOURCES:** ASOS (541) 776-1238 SAWRS.

**COMMUNICATIONS:** CTAF 119.4 ATIS 127.25 UNICOM 122.95

MEDFORD RCO 122.65 (MC MINNVILLE RADIO)

Ⓡ CASCADE APP/DEP CON 124.3 (1400-0730Z‡)

SEATTLE CENTER APP/DEP CON 124.85 (0730-1400Z‡)

TOWER 119.4 (1400-0500Z‡) GND CON 121.8

**AIRSPACE:** CLASS D svc 1400-0500Z‡ other times CLASS E.

**VOR TEST FACILITY (VOT)** 117.2

**RADIO AIDS TO NAVIGATION:** NOTAM FILE MFR.

(H) VORTACW 113.6 OED Chan 83 N42°28.77' W122°54.78' 145° 6.6 NM to fld. 2083/19E. HIWAS.

VOR portion unusable:

260°-270° byd 35 NM blo 9,000'

290°-300° byd 35 NM blo 8,500'

**MEDFORD NDB (MHW)** 356 MEF N42°23.50' W122°52.73' 151° 1.1 NM to fld.

NDB unusable:

220°-240° byd 15 NM

**PUMIE NDB (LOM)** 373 MF N42°27.06' W122°54.80' 143° 4.9 NM to fld. LOM unusable 260°-270° beyond 10 NM.

Unmonitored when ATCT closed.

**ILS/DME** 110.3 I-MFR Chan 40 Rwy 14. Class IA. LOM PUMIE NDB. LOM unusable 260°-270° beyond 10 NM.

Unmonitored when ATCT closed. Localizer backcourse unusable byd 11 NM blo 7,000', byd 13 NM blo 8,300', byd 17 NM blo 8,700'. Localizer backcourse unusable byd 20° left of course.

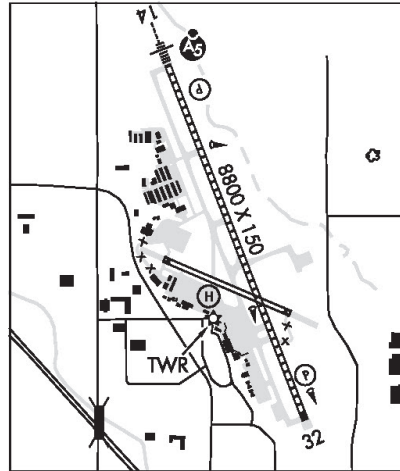

**MEMALOOSE** (See IMNAHA on page 122)

**MILLER MEM AIRPARK** (See VALE on page 145)

**MONUMENT MUNI** (12S) 1 NW UTC-8(-7DT) N44°49.89' W119°25.78'

**SEATTLE**

2323 TPA—3323(1000) NOTAM FILE MMV

**RWY 14-32:** H2104X29 (ASPH)

**RWY 14:** Hill.

**AIRPORT REMARKS:** Unattended. Intermittently clsd winters due to snow. Wildlife on and invof arpt. Rwy ends marked at each corner by a single white tire.

**COMMUNICATIONS:** CTAF 122.9

**MULINO STATE** (See PORTLAND-MULINO on page 137)

FIGURE 165.—Excerpt from Chart Supplement.

## ARKANSAS

43

**HOSSY** N34°25.35' W93°11.38' NOTAM FILE HOT.  
NDB (HW/LOM) 385 HO 050° 5.7 NM to Mem Fld.

MEMPHIS  
L-17E

**HOT SPRINGS**

**MEMORIAL FLD (HOT)** 3 SW UTC-6(-5DT) N34°28.68' W93°05.77'  
540 B S4 FUEL 100LL, JET A Class II, ARFF Index A NOTAM FILE HOT

MEMPHIS  
H-6I, L-17E  
IAP

**RWY 05-23:** H6595X150 (ASPH-GRVD) S-75, D-125, 2S-158,  
2D-210, 2D/2D2-400 HIRL 0.6% up NE

**RWY 05:** MALSR. Rgt tfc.

**RWY 23:** PAPI(P4L)—GA 3.0° TCH 40'. Pole.

**RWY 13-31:** H4098X100 (ASPH) S-28, D-36, 2D-63 MIRL  
0.4% up NW

**RWY 13:** REIL. Trees. Rgt tfc.

**RWY 31:** Pole.

**RUNWAY DECLARED DISTANCE INFORMATION**

**RWY 05:** TORA-6595 TODA-6595 ASDA-6595 LDA-6595

**RWY 13:** TORA-4100 TODA-4100 ASDA-4100 LDA-4100

**RWY 23:** TORA-6595 TODA-6595 ASDA-6595 LDA-6595

**RWY 31:** TORA-4100 TODA-4100 ASDA-4100 LDA-4100

**AIRPORT REMARKS:** Attended 1100-0400Z‡. For fuel after hrs call  
501-617-0324 or 501-617-4908. Rwy 23 PAPI OTS indef.  
ACTIVATE HIRL Rwy 05-23, MIRL Rwy 13-31, MALSR Rwy 05,  
PAPI Rwy 23 and REIL Rwy 13—CTAF.

**WEATHER DATA SOURCES:** ASOS 119.925 (501) 624-7633. HIWAS 110.0  
HOT.

**COMMUNICATIONS:** CTAF/UNICOM 123.0

RCO 122.1R 110.0T (JONESBORO RADIO)

Ⓜ MEMPHIS CENTER APP/DEP CON 128.475

**AIRSPACE:** CLASS E svc 1200-0400Z‡ other times CLASS G.

**RADIO AIDS TO NAVIGATION:** NOTAM FILE HOT.

**HOT SPRINGS (L) VOR/DME 110.0** HOT Chan 37 N34°28.72' W93°05.44' at fld. 529/4E. HIWAS.

VOR unusable:

056°-140° byd 20 NM blo 6,500'

141°-227° byd 20 NM blo 3,500'

141°-227° byd 26 NM blo 5,500'

228°-311° byd 20 NM blo 3,500'

312°-345° byd 15 NM blo 5,500'

312°-345° byd 32 NM blo 9,500'

346°-055° byd 20 NM blo 3,500'

DME unusable:

310°-035° byd 10 NM blo 11,000'

310°-035° byd 25 NM blo 12,000'

310°-035° byd 30 NM blo 17,000'

**HOSSY NDB (LOM) 385** HO N34°25.36' W93°11.38' 050° 5.7 NM to fld. Unmonitored.

ILS/DME 111.5 I-HOT Chan 52 Rwy 05. Class IT. LOM HOSSY NDB. ILS and LOM unmonitored.



**HOWARD CO** (See NASHVILLE on page 55)

FIGURE 166.—Chart Supplement (HOT).

(BYP.BYP6) 13178

ST-6039 (FAA)

DALLAS-FORT WORTH INTL (DFW)  
DALLAS-FORT WORTH, TEXAS

BONHAM SIX ARRIVAL Transition Routes

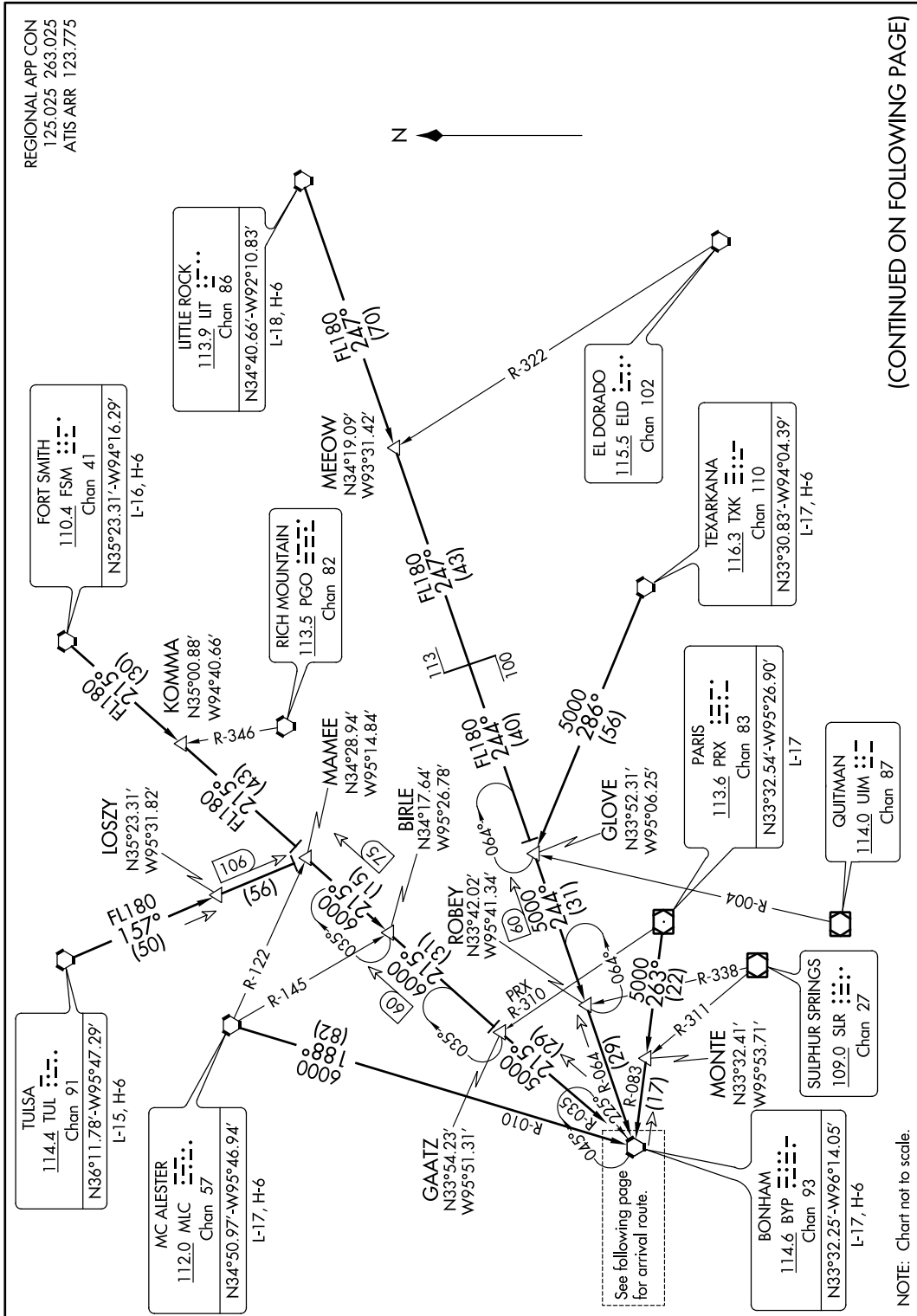

(CONTINUED ON FOLLOWING PAGE)

BONHAM SIX ARRIVAL Transition Routes  
(BYP.BYP6) 13178

DALLAS-FORT WORTH, TEXAS  
DALLAS-FORT WORTH INTL (DFW)

FIGURE 167.—BONHAM Six Arrival Transition Routes (BYP.BYP6) (DFW).

(BYP.BYP6) 13178 ST-6039 (FAA) DALLAS-FORT WORTH INTL (DFW)  
**BONHAM SIX ARRIVAL Arrival Routes** DALLAS-FORT WORTH, TEXAS

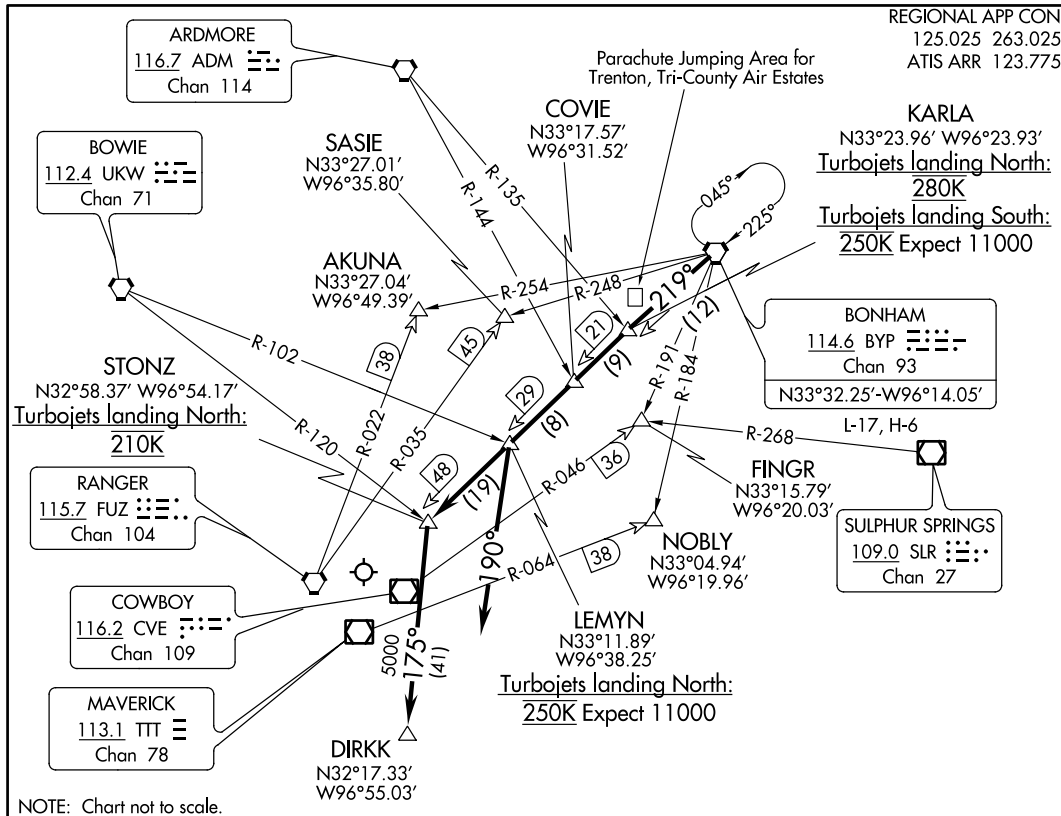

**ARRIVAL DESCRIPTION**

**FORT SMITH TRANSITION (FSM.BYP6):** From over FSM VORTAC on FSM R-215 to MAMEE INT, then on BYP R-035 to BYP VORTAC. Thence. . .

**LITTLE ROCK TRANSITION (LIT.BYP6):** From over LIT VORTAC on LIT R-247 to MEEOW INT then on LIT R-247 and BYP R-064 to GLOVE INT, then on BYP R-064 to BYP VORTAC. Thence. . .

**MC ALESTER TRANSITION (MLC.BYP6):** From over MLC VORTAC on MLC R-188 and BYP R-010 to BYP VORTAC. Thence. . .

**PARIS TRANSITION (PRX.BYP6):** From over PRX VOR/DME on PRX R-263 to MONTE INT then on BYP R-083 to BYP VORTAC. Thence. . .

**TEXARKANA TRANSITION (TXK.BYP6):** From over TXK VORTAC on TXK R-286 to GLOVE INT then on BYP R-064 to BYP VORTAC. Thence. . .

**TULSA TRANSITION (TUL.BYP6):** From over TUL VORTAC on TUL R-157 to MAMEE INT, then on BYP R-035 to BYP VORTAC. Thence. . .

. . . . **ALL AIRCRAFT:** From over BYP VORTAC on BYP R-219, thence. . .

**ALL AIRCRAFT LANDING SOUTH:** To LEMYN INT, expect vectors to final approach course.

**JETS LANDING NORTH:** FOR /E, /F, /G, and /R (RNP-2.0) EQUIPPED AIRCRAFT:  
 From over STONZ INT direct DIRKK, expect vector to final approach course prior to DIRKK, if not received by DIRKK fly present heading.

**ALL OTHERS:** To STONZ depart STONZ heading 175° for vector to final approach course.

**PROPS LANDING NORTH:** Depart LEMYN INT heading 190°, expect vectors to final approach course.

**BONHAM SIX ARRIVAL Arrival Routes** DALLAS-FORT WORTH, TEXAS  
 (BYP.BYP6) 13178 DALLAS-FORT WORTH INTL (DFW)

FIGURE 168.—BONHAM Six Arrival Routes (BYP.BYP6) (DFW).

240

TEXAS

**DALLAS**

**ADDISON** (ADS) 9 N UTC-6(-5DT) N32°58.11' W96°50.19'  
645 B S4 FUEL 100LL, JET A OX 2, 3 TPA—See Remarks LRA NOTAM FILE ADS

**RWY 15-33:** H7203X100 (ASPH-GRVD) S-60, D-120 HIRL

**RWY 15:** MALSR. PAPI(P4R)—GA 3.0° TCH 60'. Thld dspcd 979'. Pole.

**RWY 33:** REIL. PAPI(P4L)—GA 3.0° TCH 60'. Thld dspcd 772'. Bldg.

**RUNWAY DECLARED DISTANCE INFORMATION**

**RWY 15:** TORA-7202 TODA-7202 ASDA-6592 LDA-5613

**RWY 33:** TORA-7202 TODA-7202 ASDA-7202 LDA-6431

**AIRPORT REMARKS:** Attended continuously. Birds on and invof arpt. No touch and go landings without arpt managers approval. Numerous 200' buildings within 1 mile East, and South of arpt, transmission towers and water tanks West of arpt. Noise sensitive areas surround arpt. Pilots requested to use NBAA std noise procedures. TPA—1600 (956) for light acft, 2000 (1356) for large acft. Be alert: Rwy holding position markings located at the west edge of Twy A. ACTIVATE HIRL Rwy 15-33 and MALSR Rwy 15—CTAF. Flight Notification Service (ADCUS) available.

**WEATHER DATA SOURCES:** AWOS-3 (972) 386-4855 LAWRS.

**COMMUNICATIONS:** CTAF 126.0 ATIS 133.4 972-628-2439

UNICOM 122.95

Ⓜ REGIONAL APP/DEP CON 124.3

**TOWER** 126.0 (1200-0400Z‡) **GND CON** 121.6 **CLNC DEL** 119.55

**AIRSPACE:** CLASS D svc 1200-0400Z‡, other times CLASS G.

**RADIO AIDS TO NAVIGATION:** NOTAM FILE FTW.

**MAVERICK (H) VORW/DME** 113.1 TTT Chan 78 N32°52.15' W97°02.43' 054° 11.9 NM to fld. 540/6E.

All acft arriving DFW are requested to turn DME off until departure due to traffic overload of Maverick DME

**ILS/DME** 110.1 I-ADS Chan 38 Rwy 15. Class IT. Unmonitored when ATCT closed. DME also serves Rwy 33.

**ILS/DME** 110.1 I-TBQ Chan 38 Rwy 33. Class IB. Localizer unmonitored when ATCT closed. DME also serves Rwy 15.

DALLAS-FT WORTH

COPTER

H-6H, L-17C, A

IAP, AD

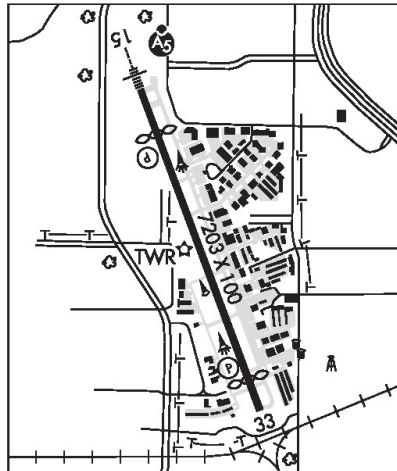

**AIR PARK-DALLAS** (F69) 16 NE UTC-6(-5DT) N33°01.41' W96°50.22'

695 S4 FUEL 100LL TPA—1890(1195) NOTAM FILE FTW

**RWY 16-34:** H3080X30 (ASPH) LIRL(NSTD)

**RWY 16:** Thld dspcd 300'. Pole.

**RWY 34:** Tree. Rgt tfc.

**AIRPORT REMARKS:** Unattended. For fuel call 972-248-4265 prior to arrival. Rwy 16-34 extensive cracking, loose asph and stones rwy. Rwy 16-34 NSTD LIRL, south 2780' of rwy lgtd. Rwy 16 and Rwy 34 NSTD centerline marking incorrect size and spacing, dspcd thld yellow. Rwy numbers 25' tall. ACTIVATE LIRL Rwy 16-34—CTAF.

**COMMUNICATIONS:** CTAF 122.9

**RADIO AIDS TO NAVIGATION:** NOTAM FILE FTW.

**MAVERICK (H) VORW/DME** 113.1 TTT Chan 78 N32°52.15' W97°02.43' 042° 13.8 NM to fld. 540/6E.

All acft arriving DFW are requested to turn DME off until departure due to traffic overload of Maverick DME

DALLAS-FT WORTH

COPTER

L-17C, A

**AIRPARK EAST** (1F7) 23 E UTC-6(-5DT) N32°48.78' W96°21.12'

510 B S4 NOTAM FILE FTW

**RWY 13-31:** H2630X30 (ASPH) LIRL

**RWY 13:** Tree. Rgt tfc.

**RWY 31:** Tree.

**AIRPORT REMARKS:** Unattended. ACTIVATE LIRL Rwy 13-31—122.9.

**COMMUNICATIONS:** CTAF/UNICOM 122.7

DALLAS-FT WORTH

COPTER

FIGURE 169.—Excerpt from Chart Supplement (ADS).



DALLAS, TEXAS

AL-768 (FAA)

LOC/DME I-TBQ <b>110.1</b> Chan <b>38</b>	APP CRS <b>335°</b>	Rwy Idg <b>6431</b> TDZE <b>644</b> Apt Elev <b>644</b>	<b>ILS or LOC RWY 33</b> DALLAS/ADDISON (ADS)		
---	------------------------	---	--	--	--

▼ Visibility reduction by helicopters NA. When control tower closed, obtain local altimeter setting on UNICOM; when not received, use Dallas-Love Field altimeter setting and increase all DAs 39 feet and all MDAs 40 feet.  
▲ MISSED APPROACH: Climb to 1500 then climbing right turn to 5000 via heading 065° and CVE VOR/DME R-046 to FINGR INT/CVE 36.4 DME and hold.

ATIS <b>133.4</b>	REGIONAL APP CON <b>124.3 282.275</b>	ADDISON TOWER * <b>126.0 (CTAF) 239.0</b>	GND CON <b>121.6</b>	CLNC DEL <b>119.55</b>	UNICOM <b>122.95</b>
----------------------	--	--	-------------------------	---------------------------	-------------------------

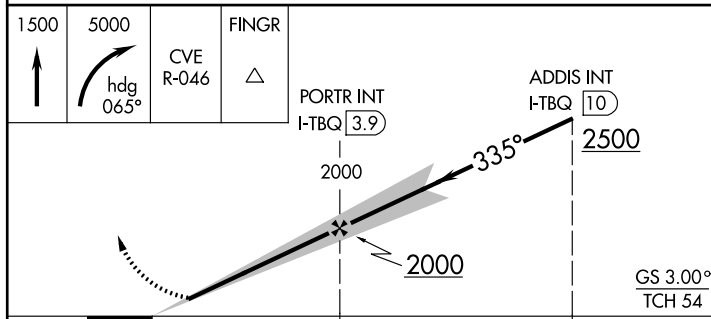
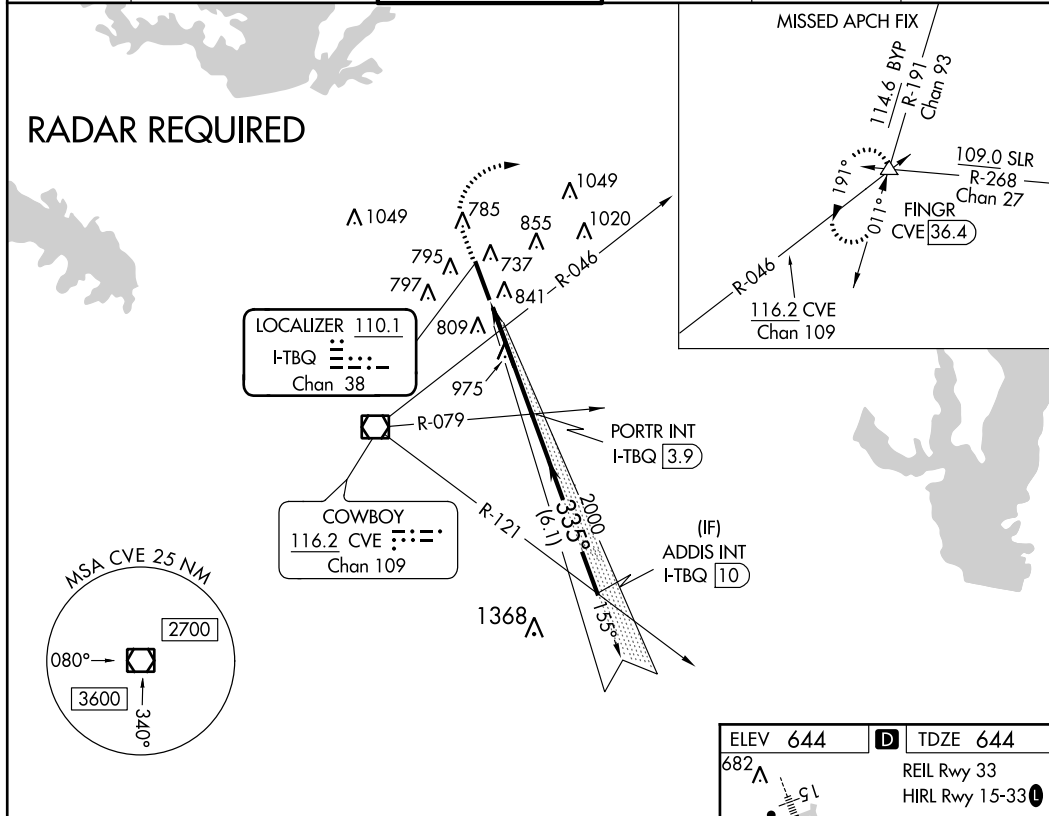

CATEGORY	A	B	C	D
S-ILS 33	894-1 250 (300-1)			
S-LOC 33	1240-1 596 (600-1)	1240-1½ 596 (600-1½)	1240-1¾ 596 (600-1¾)	1240-2 596 (600-2)
CIRCLING	1240-1 596 (600-1)	1240-1½ 596 (600-1½)	1280-2 636 (700-2)	

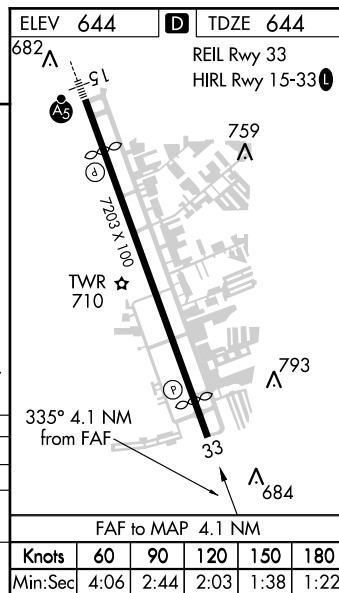

DALLAS, TEXAS  
Amdt 3 13122

32°58'N-96°50'W

DALLAS/ADDISON (ADS)  
**ILS or LOC RWY 33**

FIGURE 170.—ILS or LOC RWY 33 (ADS).

Appendix 2

DALLAS, TEXAS

AL-768 (FAA)

**RNAV (GPS) RWY 33**  
DALLAS/ADDISON (ADS)

APP CRS <b>335°</b>	Rwy Idg <b>6431</b>
	TDZE <b>644</b>
	Apt Elev <b>644</b>

**▼** DME/DME RNP-0.3 NA. Visibility reduction by helicopters NA. When control tower closed, obtain local altimeter setting on unicom; when not received use Dallas-Love Field altimeter setting and increase all MDAs 40 feet and LNAV visibility Cats C and D ¼ mile and circling Cat C visibility ¼ mile.

**▲** MISSED APPROACH: Climb to 5000 direct ULDEQ and via 060° track to FINGR and hold.

ATIS <b>133.4</b>	REGIONAL APP CON <b>124.3 282.275</b>	ADDISON TOWER ★ <b>126.0 (CTAF) 239.0</b>	GND CON <b>121.6</b>	CLNC DEL <b>119.55</b>	UNICOM <b>122.95</b>
----------------------	--	--	-------------------------	---------------------------	-------------------------

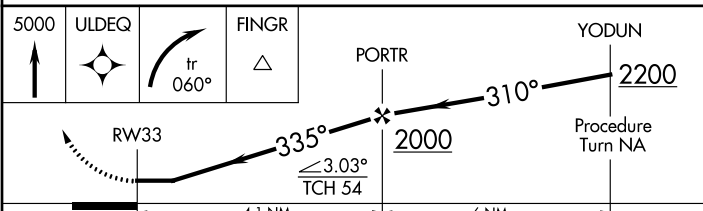
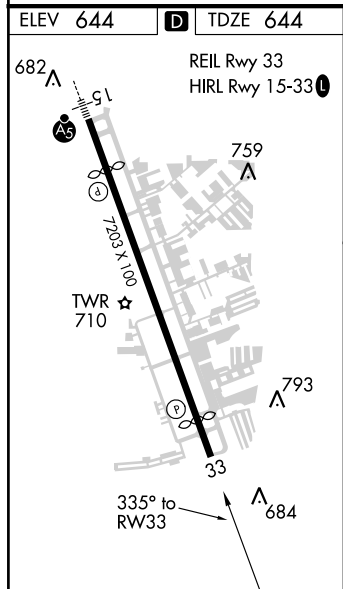
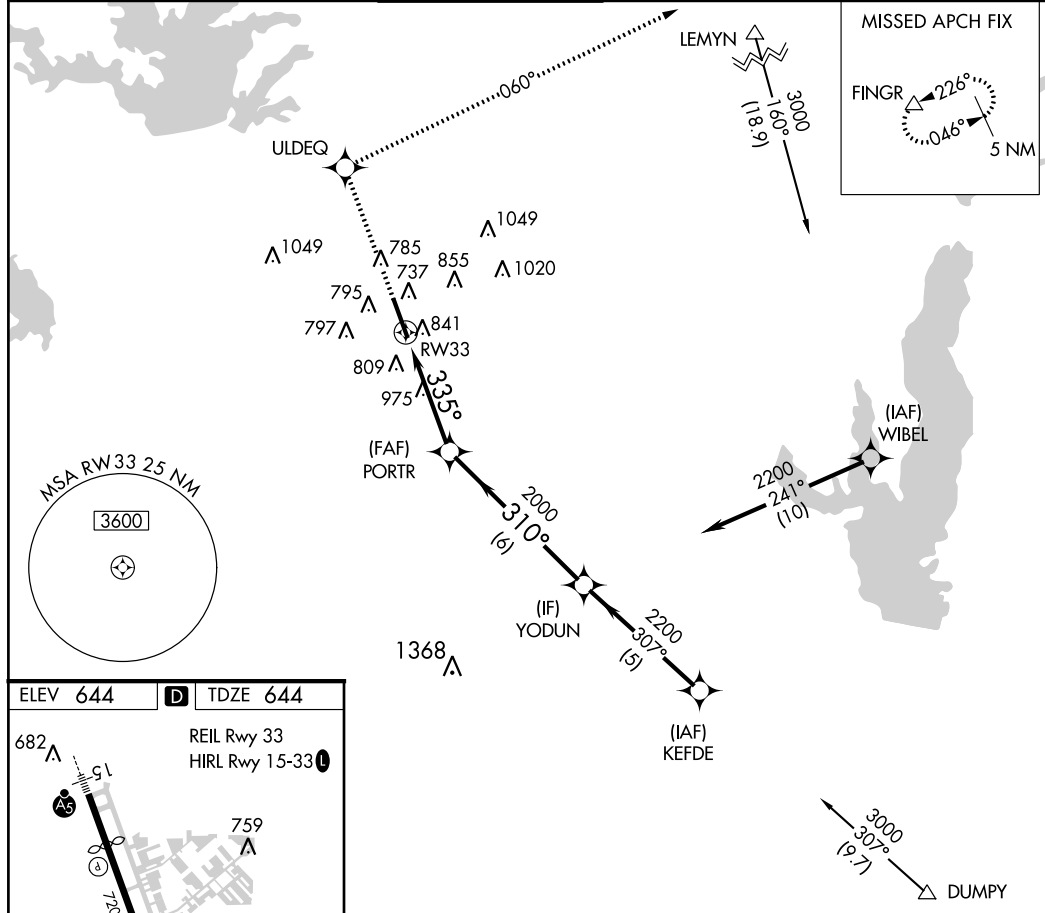

CATEGORY	A	B	C	D
LNAV MDA	1240-1	596 (600-1)	1240-1½ 596 (600-1½)	1240-1¾ 596 (600-1¾)
CIRCLING	1240-1	596 (600-1)	1240-1½ 596 (600-1½)	1280-2 636 (700-2)

DALLAS, TEXAS  
Amdt 1 13122

32°58'N-96°50'W

DALLAS/ADDISON (ADS)  
**RNAV (GPS) RWY 33**

FIGURE 171.—RNAV (GPS) RWY 33 (ADS).

**HELENA RGNL** (HLN)(KHLN) P (ARNG) 2 NE UTC-7(-6DT) N46°36.41' W111°58.97' GREAT FALLS  
 3877 B S4 FUEL 80, 100, 100LL, JET A OX 1, 3 LRA Class I, ARFF Index B NOTAM FILE HLN H-1D, L-13C  
 RWY 09-27: H9000X150 (ASPH-PFC) S-100, D-160, 2S-175, IAP, DIAP, AD  
 2D-250 HIRL

RWY 09: REIL. VASI(V4L)—GA 3.0° TCH 45'. Ground. 0.3% down.

RWY 27: MALSR. VASI(V4L)—GA 3.0° TCH 47'. Rgt tfc.

RWY 05-23: H4644X75 (ASPH-PFC) S-21, D-30 MIRL 1.2% up SW  
 RWY 05: Road.

RWY 23: PAPI(P2L)—GA 3.0° TCH 49'. Fence. Rgt tfc.

RWY 17-35: H2989X75 (ASPH-PFC) S-21, D-30 MIRL 1.7% up SE  
 RWY 35: Ground. Rgt tfc.

**MILITARY SERVICE: LGT** When twr clsd, ACTIVATE—HIRL Rwy 09-27, MIRL Rwy 05-23 and 16-34, REIL Rwy 09, MALSR Rwy 27—CTAF. FUEL A+, J8 (C406-442-2190. Opr 1200-0600Z, OT \$150 fee, 90 min PPR.) (NC-80, 100, 100LL)

**AIRPORT REMARKS:** Attended 1200-0800Z. ARFF coverage provided for scheduled Part 121 air carriers only exc with prior approval, call 406-442-2821. Ldg rights customs avbl call 406-449-5506. Rwy 17-35 and Rwy 05-23 (exc between Twy F and Rwy 09-27) not avbl for air carrier use by acft with greater than 30 passenger seats. Twy A, Twy B, and Twy C between Twy A and Rwy 35 not avbl for air carrier use by acft with greater than 30 passenger seats. When twr clsd ACTIVATE HIRL Rwy 09-27, MIRL Rwy 05-23 and Rwy 17-35, REIL Rwy 09, MALSR Rwy 27—CTAF. Ldg fee for all commercial acft and all acft over 10,000 lbs. Flight Notification Service (ADCUS) avbl. NOTE: See SPECIAL NOTICE.

**MILITARY REMARKS:** ARNG Opr Mon-Fri 1400-0030Z, exc holidays. Exercise caution while taxiing, AASF ramp not stressed for large acft. Ctc flt ops for ramp advisory 126.2, DSN 324-3055/56, C406-324-3055/56. No tran svc Sat, Sun, holidays or after 2300Z Mon-Fri.

**WEATHER DATA SOURCES:** ASOS (406) 443-4317

**COMMUNICATIONS:** CTAF 118.3 ATIS 120.4 UNICOM 122.95

RCO 122.55 255.4 (GREAT FALLS RADIO)

APP/DEP CON 119.5 229.4 (1300-0500Z)

SALT LAKE CENTER APP/DEP CON 133.4 285.4 (0500-1300Z)

TOWER 118.3 257.8 (1300-0500Z) GND CON 121.9

ARNG OPS 40.65 126.2 321.45

**AIRSPACE:** CLASS D svc 1300-0500Z other times CLASS E.

**RADIO AIDS TO NAVIGATION:** NOTAM FILE HLN.

(H) VORTACW 117.7 HLN Chan 124 N46°36.41' W111°57.21' 254° 1.2 NM to fld. 3823/16E.

VOR portion unusable:

035°-050° byd 35 NM blo 12,000'

105°-165° byd 25 NM blo 17,000'

165°-185° byd 25 NM blo 13,500'

185°-230° byd 25 NM blo 17,500'

203°-213° byd 22 NM blo 13,000'

230°-270° byd 25 NM blo 12,500'

TACAN AZIMUTH and DME unusable:

035°-070° byd 35 NM blo 13,000'

165°-185° byd 25 NM blo 13,500'

250°-300° byd 25 NM blo 14,000'

320°-035° byd 25 NM blo 13,000'

TACAN DME unusable:

035°-070° byd 35 NM blo 13,000'

105°-150° byd 25 NM

105°-210° byd 15 NM blo 11,100'

105°-210° byd 20 NM blo 12,000'

150°-165° byd 25 NM blo 17,000'

165°-185° byd 25 NM blo 13,500'

185°-210° byd 25 NM

203°-213° byd 22 NM blo 13,000'

210°-250° byd 15 NM blo 12,000'

210°-250° byd 25 NM blo 17,500'

250°-300° byd 25 NM blo 14,000'

320°-035° byd 25 NM blo 13,000'

TACAN AZIMUTH unusable:

105°-150° byd 15 NM

150°-165° byd 15 NM blo 17,000'

185°-210° byd 15 NM

210°-250° byd 15 NM blo 17,500'



CONTINUED ON NEXT PAGE

FIGURE 172.—Excerpt from Chart Supplement.

**BIG SPRING MC MAHON—WRINKLE** (BPG) 2 SW UTC-6(-5DT) N32°12.76' W101°31.30' DALLAS—FT WORTH  
 2573 B S4 FUEL 100LL, JET A NOTAM FILE BPG H-6G, L-6H  
 RWY 17-35: H8802X100 (CONC) S-60, D-150, 2D-200 MIRL IAP

RWY 17: SSALS. PAPI(P4L)—GA 3.0° TCH 45'. Rgt tfc.  
 RWY 35: PAPI(P4L)—GA 3.0° TCH 36'.  
 RWY 06-24: H4601X75 (ASPH) MIRL 0.6% up NE.  
 RWY 06: PVASI(P5IL)—GA 2.97° TCH 47'. Rgt tfc.  
 RWY 24: PVASI(P5IL)—GA 3.55° TCH 35'.

**AIRPORT REMARKS:** Attended Mon-Sat 1400-2300Z. For fuel after hours call 432-267-8952 or 432-935-3395. Prairie dogs on runways and taxiways. Extensive agricultural operations involving airport. Sandhill cranes crossing in the spring and fall. MIRL Runway 06-24 and Runway 17-35 preset low intensities, to increase intensities and ACTIVATE SSALS Runway 17 and PVASI Runway 06, Runway 24, and PAPI Runway 17 and Runway 35—CTAF.

**WEATHER DATA SOURCES:** AWOS-3 118.025 (432) 263-3842.

**COMMUNICATIONS:** CTAF/UNICOM 122.8

RCO 122.4 (SAN ANGELO RADIO)

FORT WORTH CENTER APP/DEP CON 133.7

**RADIO AIDS TO NAVIGATION:** NOTAM FILE BPG.

(L) VORTACW 114.3 BGS Chan 90 N32°23.14' W101°29.02' 180° 10.5 NM to fld. 2670/11E.

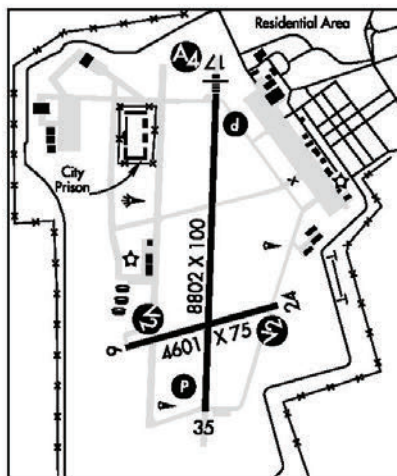

**BIGGS AAF (FORT BLISS)** (BIF)(KBIF) A 5 NE UTC-7(-6DT) N31°50.97' W106°22.80' EL PASO  
 3948 B TPA—See Remarks NOTAM FILE ABQ Not insp. H-4L, L-6F  
 RWY 03-21: H13554X150 (PEM) PCN 120 R/C/W/T HIRL DIAP, AD

RWY 03: PAPI(P4L)—GA 3.0° TCH 71'.  
 RWY 21: ALSF1. PAPI(P4L)—GA 3.0° TCH 71'. Rgt tfc. 0.3% down.

**MILITARY SERVICE:** LGT When unattended ACTIVATE 3-step HIRL Runway 03-21, High Intensity ALS Category I configuration with sequenced flashers (code) Runway 21 and PAPI Runway 21-127.9. JASU 4(A/M32A-86) 2(A/M32-95) FUEL A+ (Atlantic Avn, 1200-0400Z Mon-Sun, C915-779-2831, 1 hr prior notice, after hr C915-861-2390, after hr call out fee \$100.)  
 FLUID SP TRAN ALERT 1300-0500Z Mon-Sun, exc holidays.

**MILITARY REMARKS:** Attended Mon-Sun 1300-0500Z, except holidays. See FLIP AP/1 Supplementary Arprt Remark. RSTD PPR all acft. 24 hr prior notice, etc Airfield Ops DSN 621-8811/8330, C915-744-8811/8330. Twr and svcs avbl for all acft with PPR. PPR time valid +/- 1 hr. All acft ctc Afd Ops via PTD 30 min prior to arr. Twr and svcs unavbl before 1 hr prior to PPR sked arr. CAUTION El Paso Intl Runway 22 2 NM SE can be mistaken for Runway 21. Coyote hazard. TFC PAT Fixed Wing 5002(1054), Fixed Wing Category BCDE turbo prop 5502(1554), Rotary Wing 4502(554), Jet 6002(2054).  
 NS ABTMT VFR west arr/dep via mountain pass 15 NM NW of Biggs AAF. Avoid VFR over flight of city. Fly 1500' AGL, 1500' horizontal distance from mountain dwellings. MISC Approval required for access to ramp. Temporary storage of classified material avbl at Afd Ops. Intl garbage cap ltd. Expect delays unless placed in garbage bags prior to arrival. Hangar space extremely limited for transient acft. KBIF manual obsn and wx forecaster avbl Mon-Fri 1300-0500Z, clsd holidays. DSN 621-1215/1214, C915-744-1215/1214, OT 25th OWS, Davis Monthan AFB, DSN 228-6598/6599.

**COMMUNICATIONS:** ATIS 120.0 254.3 (C915-772-9412) PTD 122.7

(R) EL PASO APP CON 119.15 353.5 (South of V16) 124.25 298.85 (North of V16)

TOWER 127.9 342.25 (Mon-Sun 1300-0500Z, except holidays). Advisory svc twr freq other times.

(R) EL PASO DEP CON 121.3 263.0

EL PASO CLNC DEL 125.0 379.1

**AIRSPACE:** CLASS D svc 1300-0500Z Mon-Sat except holidays other times CLASS E.

**RADIO AIDS TO NAVIGATION:** NOTAM FILE ABQ.

NEWMAN (L) VORTACW 112.4 EWM Chan 71 N31°57.10' W106°16.34' 210° 8.2 NM to fld. 4040/12E.

DME portion unusable:  
 220°-255° byd 25 NM blo 12,000'

**COMM/NAV/WEATHER REMARKS:** Radar—See Terminal FLIP for Radar Minima.

**BIRD DOG AIRFIELD** (See KRUM on page 297)

**BISHOP** (See DECATUR on page 245)

FIGURE 172A.—Excerpt from Chart Supplement.

## MONTANA

85

## CONTINUED FROM PRECEDING PAGE

**CAPITOL NDB (HW)** 335 CVP N46°36.40' W111°56.23' 258° 1.9 NM to fld. NDB unmonitored when ATCT clsd.  
**HAUSER NDB (MHW)** 386 HAU N46°34.13' W111°45.48' 268° 9.6 NM to fld. NDB unmonitored when HLN  
 ATCT clsd.

**ILS 110.1** I-HLN Rwy 27. Unmonitored when ATCT closed. Localizer backcourse unusable by 22° rgt of course,  
 unusable within 2.7 DME.

**HINSDALE** (6U5) 0 SE UTC-7(-6DT) N48°23.28' W107°05.00' **BILLINGS**

2220 NOTAM FILE GTF

**RWY 07-25:** 2200X75 (TURF) LIRL(NSTD) 0.7% up W**RWY 07:** Road.**RWY 10-28:** 2160X200 (TURF) 0.3% up W**RWY 10:** Road.**RWY 16-34:** 1960X75 (TURF) 1.5% up S**RWY 16:** P-line.**RWY 34:** Fence.**AIRPORT REMARKS:** Unattended. Rwy soft when wet. Hay bales and farm equipment adjacent to rwy. Rwy not clearly defined.

Rwy 16-34, Rwy 07-25 and Rwy 10-28 marked with white cones full length of rwy. Rwy 16 p-lines marked with globes.

Rwy 07-25 NSTD LIRL 335' spacing between lgts, one thld lgt each end. For rwy lgts phone 406-364-2272/2387.

**COMMUNICATIONS:** CTAF 122.9**HOGELAND** (6U6) 1 NW UTC-7(-6DT) N48°51.61' W108°39.66' **BILLINGS**

3139 B NOTAM FILE GTF

**RWY 07-25:** 3140X60 (TRTD) 0.6% up W**RWY 16-34:** 1230X50 (TURF)**RWY 34:** Bldg.**AIRPORT REMARKS:** Unattended. Rwy 16-34 for emerg use only, road and drainage ditch parallel rwy on east side. Rwy 07-25  
 patches of loose aggregate and grvl.**COMMUNICATIONS:** CTAF 122.9**HOT SPRINGS** (S09) 2 E UTC-7(-6DT) N47°36.75' W114°36.81' **GREAT FALLS**

2763 B NOTAM FILE GTF

**RWY 06-24:** H3550X45 (ASPH-TRTD) MIRL**RWY 24:** Thld dspclcd 411'. Road.**AIRPORT REMARKS:** Unattended. Ultralights on and in vicinity of arpt. Occasional snow removal. Rwy 06-24 asph grvl  
 composition full length. Rwy 24 has 411' unlighted, 2169' lgtcd at ngt. Rwy 06-24 cones adjacent to MIRL full length  
 and dspclcd thld marked with white cones. Rwy 06 and Rwy 24 numbers 4' x 8' in measure, thld line and rwy lines NSTD.**COMMUNICATIONS:** CTAF 122.9**HYSHAM** (6U7) 2 E UTC-7(-6DT) N46°17.61' W107°11.60' **BILLINGS**

2624 B NOTAM FILE GTF

**RWY 07-25:** H3060X45 (ASPH-TRTD) LIRL**AIRPORT REMARKS:** Unattended. 1030' dirt extension east of Rwy 07 thld soft when wet. Rwy 07 basic markings NSTD  
 numbers and stripes, markings are faded. Rwy 25 basic markings NSTD small numbers and stripes, markings are faded.  
 Numerous rwy lgts inop. ACTIVATE LIRL Rwy 07-25—CTAF.**COMMUNICATIONS:** CTAF 122.9**JORDAN** (JDN) 2 NW UTC-7(-6DT) N47°19.73' W106°57.16' **BILLINGS**

2662 B NOTAM FILE JDN

**RWY 10-28:** H4300X75 (ASPH-PFC) S-12.5 MIRL**RWY 28:** PAPI(P2L)—GA 3.0° TCH 29'.**AIRPORT REMARKS:** Unattended. ACTIVATE MIRL Rwy 10-28 and PAPI Rwy 28—CTAF.**COMMUNICATIONS:** CTAF 122.9**RADIO AIDS TO NAVIGATION:** NOTAM FILE GGW.**GLASGOW (H) VORW/DME** 113.9 GGW Chan 86 N48°12.92' W106°37.53' 180° 54.8 NM to fld. 2283/14E.**NDB (MHW)** 263 JDN N47°20.00' W106°56.29' at fld. NOTAM FILE JDN. VFR only.**JUDITH MOUNTAIN** N47°13.03' W109°13.31' **GREAT FALLS**

RCO 122.2 (GREAT FALLS RADIO)

L-13D

FIGURE 173.—Excerpt from Chart Supplement.

(JEN.JEN9) 09351

GLEN ROSE NINE ARRIVAL

ST-6039 (FAA)

DALLAS-FT. WORTH, TEXAS

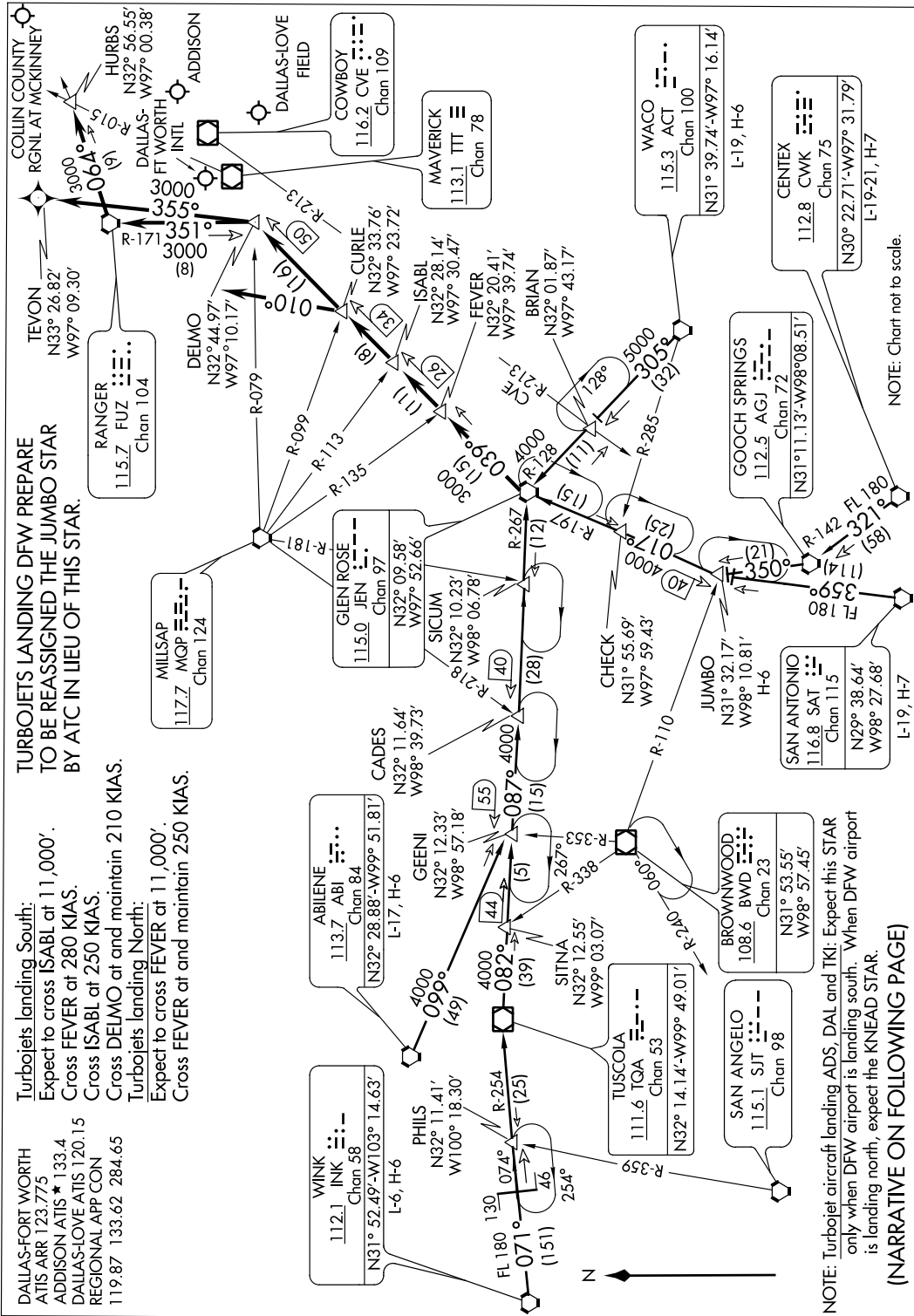

GLEN ROSE NINE ARRIVAL

DALLAS-FT. WORTH, TEXAS

(JEN.JEN9) 09351

FIGURE 174.—GLEN ROSE Nine Arrival (JEN.JEN9).

(JEN.JEN9) 09351

**GLEN ROSE NINE ARRIVAL**

ST-6039 (FAA)

DALLAS-FT. WORTH, TEXAS

## ARRIVAL DESCRIPTION

ABILENE TRANSITION (ABI.JEN9): From over ABI VORTAC via R-099 to GEENI INT, then via JEN R-267 to JEN VORTAC. Thence . . . .

CENTEX TRANSITION (CWK.JEN9): From over CWK VORTAC via CWK R-321 and AGJ R-142 to AGJ VORTAC, then via AGJ R-350 to JUMBO INT, then via JEN R-197 to JEN VORTAC. Thence . . . .

JUMBO TRANSITION (JUMBO.JEN9): From over JUMBO INT via JEN R-197 to JEN VORTAC. Thence . . . .

SAN ANTONIO TRANSITION (SAT.JEN9): From over SAT VORTAC via SAT R-359 to JUMBO INT, then via JEN R-197 to JEN VORTAC. Thence . . . .

WACO TRANSITION (ACT.JEN9): From over ACT VORTAC via ACT R-305 and JEN R-128 to JEN VORTAC. Thence . . . .

WINK TRANSITION (INK.JEN9): From over INK VORTAC via INK R-071 and TQA R-254 to TQA VOR/DME, then via TQA R-082 to GEENI INT, then via JEN R-267 to JEN VORTAC. Thence . . . .

. . . . ALL AIRCRAFT: From over JEN VORTAC via JEN R-039, thence . . . .

ALL AIRCRAFT LANDING NORTH: To CURLE INT, expect vectors to final approach course.

JETS LANDING SOUTH: To DELMO, depart DELMO heading 355°.

For /E, /F, /G and /R (RNP 2.0) EQUIPMENT SUFFIXED AIRCRAFT: From over DELMO WP direct TEVON WP, expect vector to final approach course prior to TEVON WP. If not received by TEVON fly present heading.

NON TURBOJETS LANDING SOUTH: To CURLE INT, depart CURLE heading 010° for vectors to final approach course.

AIRCRAFT LANDING DAL, ADS, TKI: To DELMO INT, depart DELMO via FUZ R-171 to FUZ VORTAC then FUZ R-064 to HURBS INT, expect vectors to final approach course.

**GLEN ROSE NINE ARRIVAL**

DALLAS-FT. WORTH, TEXAS

(JEN.JEN9) 09351

FIGURE 175.—GLEN ROSE Nine Arrival (JEN.JEN9).

**DALLAS—FORT WORTH**

**DALLAS/FORT WORTH INTL** (DFW) 12 NW UTC-6(-5DT) N32°53.81' W97°02.28' **DALLAS—FT WORTH**  
 607 B FUEL 100LL, JET A OX 1, 3 AOE Class I, ARFF Index E NOTAM FILE DFW **COPTER**  
**RWY 17C-35C:** H13401X150 (CONC-GRVD) S-120, D-200, 2S-175, 2D-600, 2D/2D2-850 HIRL **H-6H, L-17C, A**  
 CL **IAP, AD**  
**RWY 17C:** ALSF2. TDZL. PAPI(P4L)—GA 3.0° TCH 74'.  
**RWY 35C:** ALSF2. TDZL. PAPI(P4L)—GA 3.0° TCH 76'.  
**RWY 17R-35L:** H13401X200 (CONC-GRVD) S-120, D-200, 2S-175, 2D-600, 2D/2D2-850 HIRL CL  
**RWY 17R:** MALSR. TDZL. PAPI(P4L)—GA 3.0° TCH 68'.  
**RWY 35L:** MALSR. TDZL. PAPI(P4L)—GA 3.0° TCH 63'.  
**RWY 18L-36R:** H13400X200 (CONC-GRVD) S-120, D-200, 2S-175, 2D-600, 2D/2D2-850 HIRL CL  
**RWY 18L:** MALSR. TDZL. PAPI(P4L)—GA 3.0° TCH 70'.  
**RWY 36R:** MALSR. TDZL. PAPI(P4L)—GA 3.0° TCH 66'.  
**RWY 18R-36L:** H13400X150 (CONC-GRVD) S-120, D-200, 2S-175, 2D-600, 2D/2D2-850 HIRL CL  
**RWY 18R:** ALSF2. TDZL. PAPI(P4L)—GA 3.0° TCH 74'.  
**RWY 36L:** MALSR. TDZL. PAPI(P4L)—GA 3.0° TCH 72'.  
**RWY 13R-31L:** H9301X150 (CONC-GRVD) S-120, D-200, 2S-175, 2D-600, 2D/2D2-850 HIRL CL  
**RWY 13R:** MALSR. TDZL. PAPI(P4L)—GA 3.0° TCH 71'.  
**RWY 31L:** REIL. PAPI(P4L)—GA 3.13° TCH 72'.  
**RWY 13L-31R:** H9000X200 (CONC-GRVD) S-120, D-200, 2S-175, 2D-600, 2D/2D2-850 HIRL CL  
**RWY 13L:** REIL. PAPI(P4L)—GA 3.0° TCH 82'. Thld displcd 625'. 0.5% down.  
**RWY 31R:** MALSR. TDZL. PAPI(P4L)—GA 3.0° TCH 69'. 0.5% up.  
**RWY 17L-35R:** H8500X150 (CONC-GRVD) S-120, D-200, 2S-175, 2D-600, 2D/2D2-850 HIRL CL  
**RWY 17L:** ALSF2. TDZL. PAPI(P4L)—GA 3.0° TCH 77'. Antenna. 0.6% up.  
**RWY 35R:** ALSF2. TDZL. PAPI(P4R)—GA 3.0° TCH 73'. 0.6% down.

**LAND AND HOLD—SHORT OPERATIONS**

LDG RWY	HOLD—SHORT POINT	AVBL LDG DIST
RWY 17C	TWY B	10460
RWY 18R	TWY B	10100
RWY 35C	TWY EJ	9050
RWY 36L	TWY Z	10650

**RUNWAY DECLARED DISTANCE INFORMATION**

**RWY 13L:**TORA-9000 TODA-9000 ASDA-9000 LDA-8375  
**RWY 13R:**TORA-9301 TODA-9301 ASDA-9301 LDA-9301  
**RWY 17C:**TORA-13401 TODA-13401 ASDA-13401 LDA-13401  
**RWY 17L:**TORA-8500 TODA-8500 ASDA-8500 LDA-8500  
**RWY 17R:**TORA-13401 TODA-13401 ASDA-13401 LDA-13401  
**RWY 18L:**TORA-13400 TODA-13400 ASDA-13400 LDA-13400  
**RWY 18R:**TORA-13400 TODA-13400 ASDA-13400 LDA-13400  
**RWY 31L:**TORA-9301 TODA-9301 ASDA-9301 LDA-9301  
**RWY 31R:**TORA-8375 TODA-8375 ASDA-8375 LDA-8375  
**RWY 35C:**TORA-13401 TODA-13401 ASDA-13401 LDA-13401  
**RWY 35L:**TORA-13401 TODA-13401 ASDA-13401 LDA-13401  
**RWY 35R:**TORA-8500 TODA-8500 ASDA-8500 LDA-8500  
**RWY 36L:**TORA-13400 TODA-13400 ASDA-13400 LDA-13400  
**RWY 36R:**TORA-13400 TODA-13400 ASDA-13400 LDA-13400

**CONTINUED ON NEXT PAGE**

FIGURE 176.—ILS-1 RWY 36L, Dallas-Fort Worth Intl.



## CONTINUED FROM PRECEDING PAGE

**AIRPORT REMARKS:** Attended continuously. Rwy 17L–35R CLOSED 0400–1200Z except PPR. Rwy 13R–31L CLOSED 0400–1200Z except PPR. Rwy 13L–31R CLOSED 0400–1200Z except PPR. Rwy 31R last 625' CLOSED indef. Visual screen 20' AGL 1180' south AER 35C. Visual screen 22' AGL 1179' south AER 35L. ASDE-X SURVEILLANCE system in use. Pilots should opr transponders with mode C on all twys and rwys. PPR for acft with wingspan 215' or greater (GROUP VI), call arpt ops 972–973–3112 for follow me services while taxiing to and from ramp and rwys. Rwy 13L, Rwy 17L, Rwy 31R, and Rwy 35R rwy visual range touchdown, midpoint and rollout avbl. Rwy 31L and Rwy 31R runway visual range touchdown and rollout avbl. Arpt under construction, PAEW in movement areas. Birds on and in vicinity of arpt. Tkf distance for Rwy 17L from Twy Q2 is 8196'. Tkf distance for Rwy 35R from Twy Q9 is 8196'. Tkf distance for Rwy 17R from Twy EG is 13082' and from Twy EH is 12816'. Tkf distance for Rwy 35L from Twy EQ is 13084' and from Twy EP is 12811'. Tkf distance for Rwy 36R from Twy WP is 12815', from Twy WQ is 13082'. Tkf distance for Rwy 18L from Twy WG is 13082', from Twy WH is 12815'. Tkf distance for Rwy 17C from Twy EG is 13,082'. Tkf distance for Rwy 18R from Twy WG is 13,082'. Land and hold–short signs on Rwy 17C at Twy B 10,460' south of Rwy 17C thld, Rwy 18R at Twy B 10,100' south of Rwy 18R thld, Rwy 35C at Twy EJ 9050' north of Rwy 35C thld, Rwy 36L at Twy Z 10,650' north of Rwy 36L thld, lgted and marked with in–pavement pulsating white lgts. Twy G11 east of Twy G clsd to acft with wingspan 125' and greater. Acft using gates D6–D17 must obtain approval from DFW ramp twr 129.95 prior to entering ramp and prior to pushback 1130–0430Z. Use extreme care at other times. Apron Terminal E ramp work in progress, ctc DFW ramp on 131.0 1530–1200Z for Terminal E procedure change. Apron entrance/exit Points 32, 33, 34, 35, 36, 37, 38 and 39 clsd to acft with wingspan greater than 135'. Acft pushing back or powering back on Terminal B Apron have right of way. Frequent ground support equip under escort crossing Twys A and B at Twy HA. Apron entrance/exit points 5, 7, 42 and 44 clsd to acft with wingspan 118' and greater. Apron entrance/exit points 42 and 44 clsd to acft with wingspan greater than 118'. Terminal B apron taxilane btn apron entrance/exit point taxilanes 110 and 115 clsd to acft with wingspan 118' and greater. Apron entrance/exit points 22, 24, 105, 107 and 122 clsd to acft with wingspan 125' and greater. Apron entrance/exit point 124 clsd to acft with wingspan 200' and greater. Twy A5 clsd to acft with wingspan 171' and greater. Twys may require judgemental oversteering for large acft. Apron entrance/exit points 52 and 53 clsd to acft with wingspan 171' and greater. Acft exiting via apron entrance/exit points 42, 43 and 44 ctc Gnd Con prior to taxiing. PPR general aviation ops 0400–1200Z, call arpt ops 972–973–3112. PPR from arpt ops for general aviation acft to proceed to airline terminal gate except to general aviation facility. PPR from the primary tenant airlines to operate within the central terminal area. Proper minimum object free area distances may not be maintained for ramp/apron taxi lanes. Twy edge reflectors along all twys. Landing fee. Flight Notification Service (ADCUS) available. NOTE: See Land and Hold Short Operations, Intersection Departures During Periods of Darkness, Noise Abatement Procedures and Continuous Power Facilities.

**WEATHER DATA SOURCES:** ASOS (972) 453–0992 LLWAS.

**COMMUNICATIONS:** D-ATIS ARR 123.775 (972) 615–2701 D-ATIS DEP 135.925 (972) 615–2701 UNICOM 122.95

Ⓡ RGNL APP CON 125.025 133.525 (E) 119.875 133.625 (W)

DFW TOWER 126.55 127.5 (E) 124.15 134.9 (W) GND CON 121.65 121.8 (E) 121.85 (W)

CLNC DEL 128.25

Ⓡ RGNL DEP CON 118.55 (E) 126.475 (W) 124.825 (N) 125.125 (S)

**AIRSPACE:** CLASS B See VFR Terminal Area Chart

**RADIO AIDS TO NAVIGATION:** NOTAM FILE FTW.

MAVERICK (H) VOR/DME 113.1 TTT Chan 78 N32°52.15' W97°02.43' 358° 1.7 NM to fld. 540/6E.

ILS/DME 109.5 I-LWN Chan 32 Rwy 13R. Class IE.

ILS/DME 110.3 I-FLQ Chan 40 Rwy 17C. Class IIIE. DME also serves Rwy 35C.

ILS/DME 111.75 I-PPZ Chan 54(Y) Rwy 17L. Class IIIE. DME also serves Rwy 35R.

ILS/DME 111.35 I-JHZ Chan 50(Y) Rwy 17R. Class IE. DME also serves Rwy 35L.

ILS/DME 110.55 I-CIX Chan 42(Y) Rwy 18L. Class IE. DME also serves Rwy 36R.

ILS/DME 111.9 I-VYN Chan 56 Rwy 18R. Class IIIE. DME also serves Rwy 36L.

ILS/DME 110.9 I-RRA Chan 46 Rwy 31R. Class IE.

ILS/DME 110.3 I-PKQ Chan 40 Rwy 35C. Class IIIE. DME also serves Rwy 17C. OM/comlo also serves Rwy 35L.

ILS/DME 111.35 I-UWX Chan 50(Y) Rwy 35L. Class IE. OM/comlo also serves Rwy 35R. LOC unusable byd 14 NM blo 3,400'. DME also serves Rwy 17R.

ILS/DME 111.75 I-AJQ Chan 54(Y) Rwy 35R. Class IIIE. DME also serves Rwy 17L. LOC unusable byd 16 NM 5° right of course.

ILS/DME 111.9 I-BXN Chan 56 Rwy 36L. Class ID. DME also serves Rwy 18R. OM also serves Rwy 36R. LOC unusable byd 15 NM 5° right of course.

ILS/DME 110.55 I-FJN Chan 42(Y) Rwy 36R. Class IE. OM also serves Rwy 36L. DME also serves Rwy 18L.

**COMM/NAV/WEATHER REMARKS:** All acft arriving DFW are requested to turn DME off until dep due to tfc overload of Maverick DME.

---

**DALLAS/FORT WORTH INTL** (See DALLAS–FORT WORTH on page 243)

---

**DAN E RICHARDS MUNI** (See PADUCAH on page 325)

---

**DAN JONES INTL** (See HOUSTON on page 279)

---

FIGURE 176A.—ILS-1 RWY 36L, Dallas-Fort Worth Intl.

DALLAS-FORT WORTH, TEXAS

AL-6039 (FAA)

13122

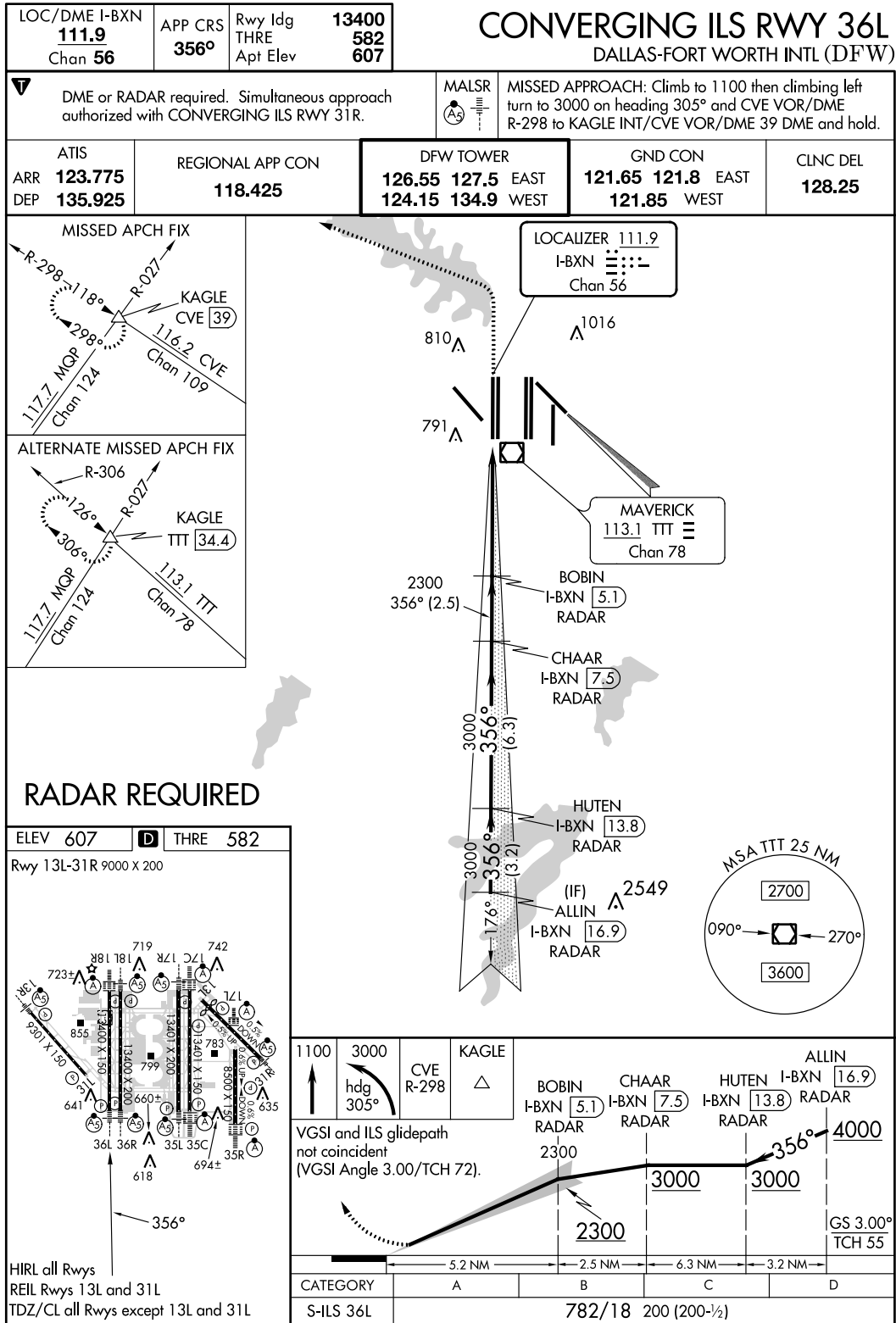

FIGURE 177.—Converging ILS RWY 36L (DFW).

DALLAS, TEXAS

AL-106 (FAA)

13234

LOC/DME I-DAL <b>111.5</b> Chan 52	APP CRS <b>130°</b>	Rwy Idg <b>7352</b> THRE <b>480</b> Apt Elev <b>487</b>	<b>ILS or LOC Y RWY 13L</b> DALLAS-LOVE FIELD (DAL)
--	------------------------	---	--

⚠ Circling Rwy 18/36 NA at night. DME required. Simultaneous approach authorized with Rwy 13R. Simultaneous approach authorized with DFW ILS or LOC Rwy 17L.	MALS R MISSED APPROACH: Climb to 1000 then climbing left turn to 3000 on heading 100° and CVE VOR/DME R-118 to DUMPY/CVE 24.4 DME and hold.
--	--

ATIS <b>120.15</b>	REGIONAL APP CON NORTH <b>124.3 282.275</b> SOUTH <b>125.2 343.65</b>	LOVE TOWER <b>123.7 239.3</b>	GND CON <b>121.75 348.6</b>	CLNC DEL <b>127.9</b>
-----------------------	---	----------------------------------	--------------------------------	--------------------------

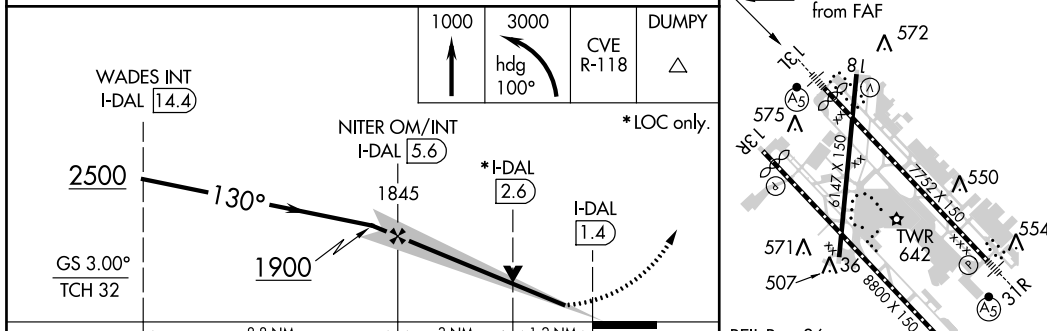
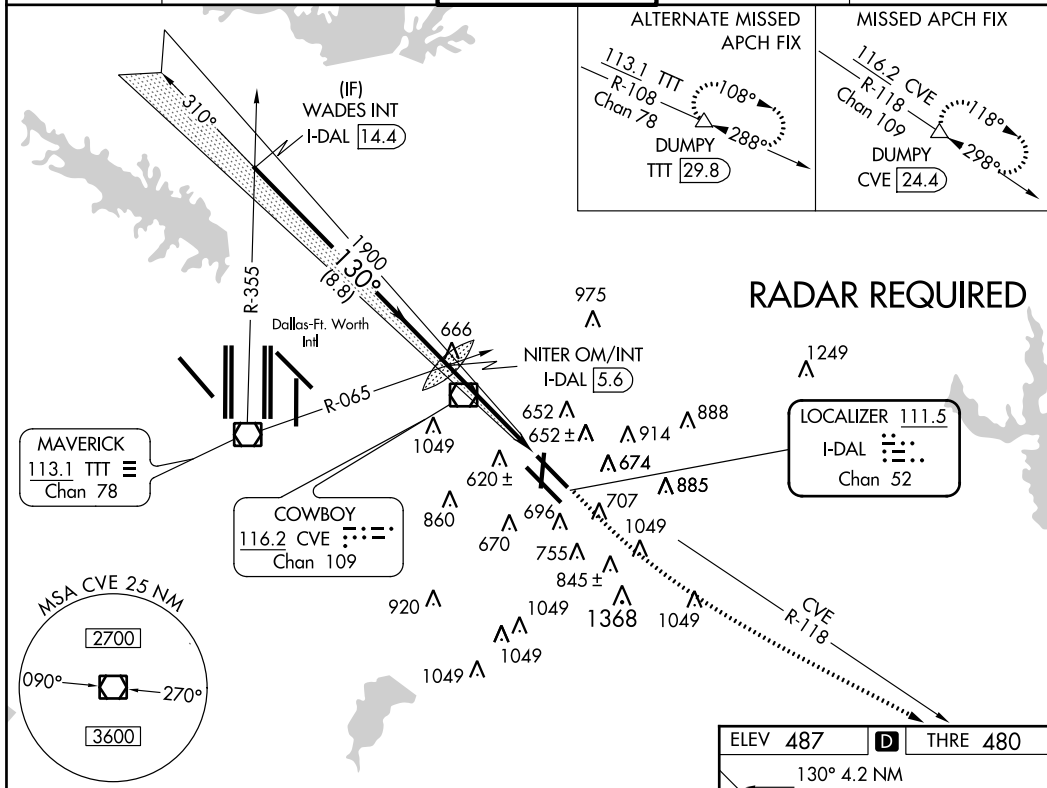

	ELEV 487	D	THRE 480				
	130° 4.2 NM from FAF						
CATEGORY	A	B	C	D			
S-ILS 13L	680/18			200 (200-½)			
S-LOC 13L	920/24	440 (500-½)	920/40	440 (500-¾)			
CIRCLING	1020-1	533 (600-1)	1020-1½ 533 (600-1½)	1160-2¼ 673 (700-2¼)			
FAF to MAP 4.2 NM							
		Knots	60	90	120	150	180
		Min:Sec	4:12	2:48	2:06	1:41	1:24

DALLAS, TEXAS

Amdt 32 27JUN13

32°51'N-96°51'W

DALLAS-LOVE FIELD (DAL)

**ILS or LOC Y RWY 13L**

FIGURE 178.—ILS or LOC Y RWY 13L (DAL).

DALLAS, TEXAS

AL-742 (FAA)

13178

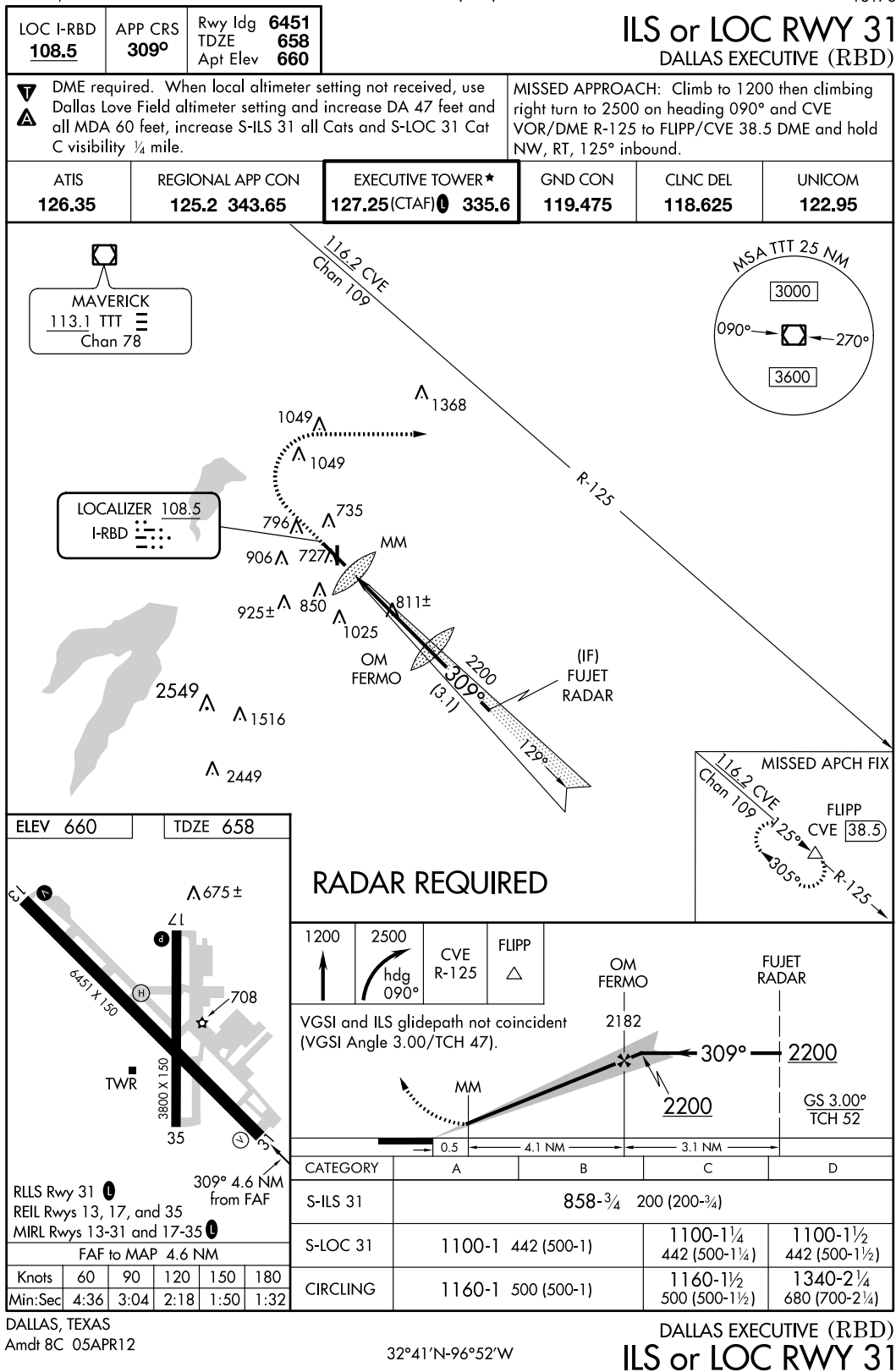
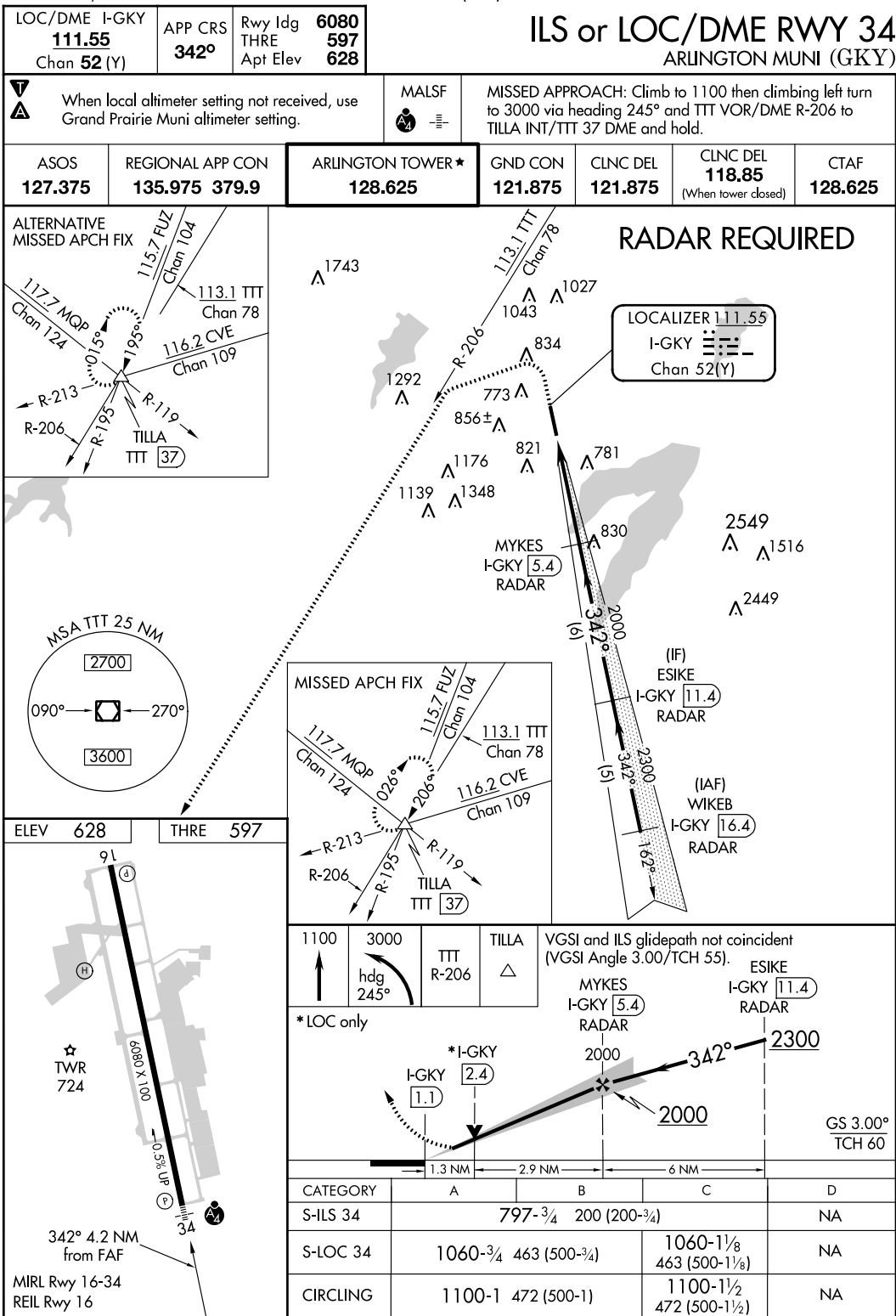

FIGURE 179.—ILS or LOC RWY 31 (RBD).

ARLINGTON, TEXAS

AL-5189 (FAA)

13066



ARLINGTON, TEXAS  
Amdt 2 09FEB12

ARLINGTON MUNI (GKY)  
32°40'N-97°06'W **ILS or LOC/DME RWY 34**

FIGURE 180.—ILS or LOC/DME RWY 34 (GKY).

208

TEXAS

**ARCHER CITY MUNI** (T39) 1 SE UTC-6(-5DT) N33°34.94' W98°37.12'  
 1065 S2 NOTAM FILE FTW  
**RWY 17-35:** H3200X60 (ASPH) S-12.5  
 RWY 17: Road.  
**AIRPORT REMARKS:** Unattended. Wildlife on and invof arpt. 70' AGL drilling rig 700' northwest of Rwy 17-35. Rwy 17-35 loose grvl, tall grass and pot holes on rwy.  
**COMMUNICATIONS:** CTAF 122.9  
**RADIO AIDS TO NAVIGATION:** NOTAM FILE SPS.  
**WICHITA FALLS (H) VORTACW** 112.7 SPS Chan 74 N33°59.24' W98°35.61' 173° 24.3 NM to fld. 1133/10E.

DALLAS-FT WORTH  
 L-17B

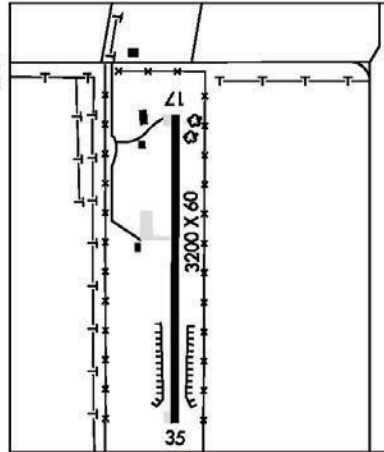

**ARDYTH** N27°38.54' W99°27.48' NOTAM FILE SJT.  
 NDB (MHW) 405 AGH 174° 5.9 NM to Laredo Intl.

BROWNSVILLE  
 L-20G

**ARLEDGE FLD** (See STAMFORD on page 351)

**ARLINGTON MUNI** (GKY) 4 S UTC-6(-5DT) N32°39.83' W97°05.66'  
 628 B S4 FUEL 100LL, JET A OX 4 TPA-1628(1000) NOTAM FILE GKY  
**RWY 16-34:** H6080X100 (CONC) S-60 MIRL 0.5% up NW  
**RWY 16:** REIL. PAPI(P4L)-GA 3.0° TCH 42'.  
**RWY 34:** MALSF. PAPI(P4L)-GA 3.0° TCH 55'.

DALLAS-FT WORTH  
 COPTER  
 H-6H, L-17C, A  
 IAP, AD

**AIRPORT REMARKS:** Attended continuously. Self serve fuel with major credit card. Helicopter test facility at arpt mostly from private helipad adjoining ldg area. Extensive helicopter traffic west of rwy. Rwy 34 PAPI unusable byd 8° right of centerline. MIRL Rwy 16-34 preset medium ints, higher ints by twr request. When twr clsd ACTIVATE MALSF Rwy 34-CTAF. PAPI Rwy 16 and Rwy 34 opr continuously.  
**WEATHER DATA SOURCES:** ASOS 127.375 (817) 557-0251.  
**COMMUNICATIONS:** CTAF 128.625  
 Ⓡ REGIONAL APP/DEP CON 135.975  
**TOWER** 128.625 (1300-0300Z±) **GND CON/CLNC DEL** 121.875  
**CLNC DEL** 118.85 (RGNL APP CON when twr clsd)  
**AIRSPACE:** CLASS D svc 1300-0300Z± other times CLASS G.  
**RADIO AIDS TO NAVIGATION:** NOTAM FILE FTW.  
**MAVERICK (H) VORW/DME** 113.1 TTT Chan 78 N32°52.15' W97°02.43' 186° 12.6 NM to fld. 540/6E.  
 All acft arriving DFW are requested to turn DME off until departure due to traffic overload of Maverick DME  
**ILS/DME** 111.55 I-GKY Chan 52(Y) Rwy 34. Class IE. LOC unusable byd 15° right of course. Unmonitored when ATCT clsd.

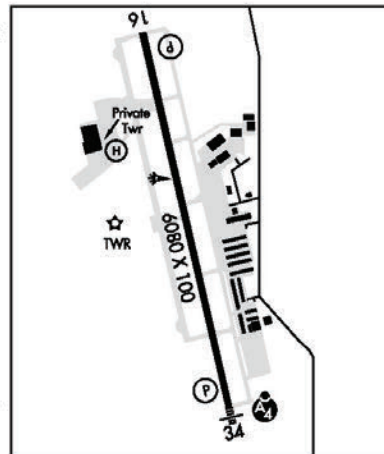
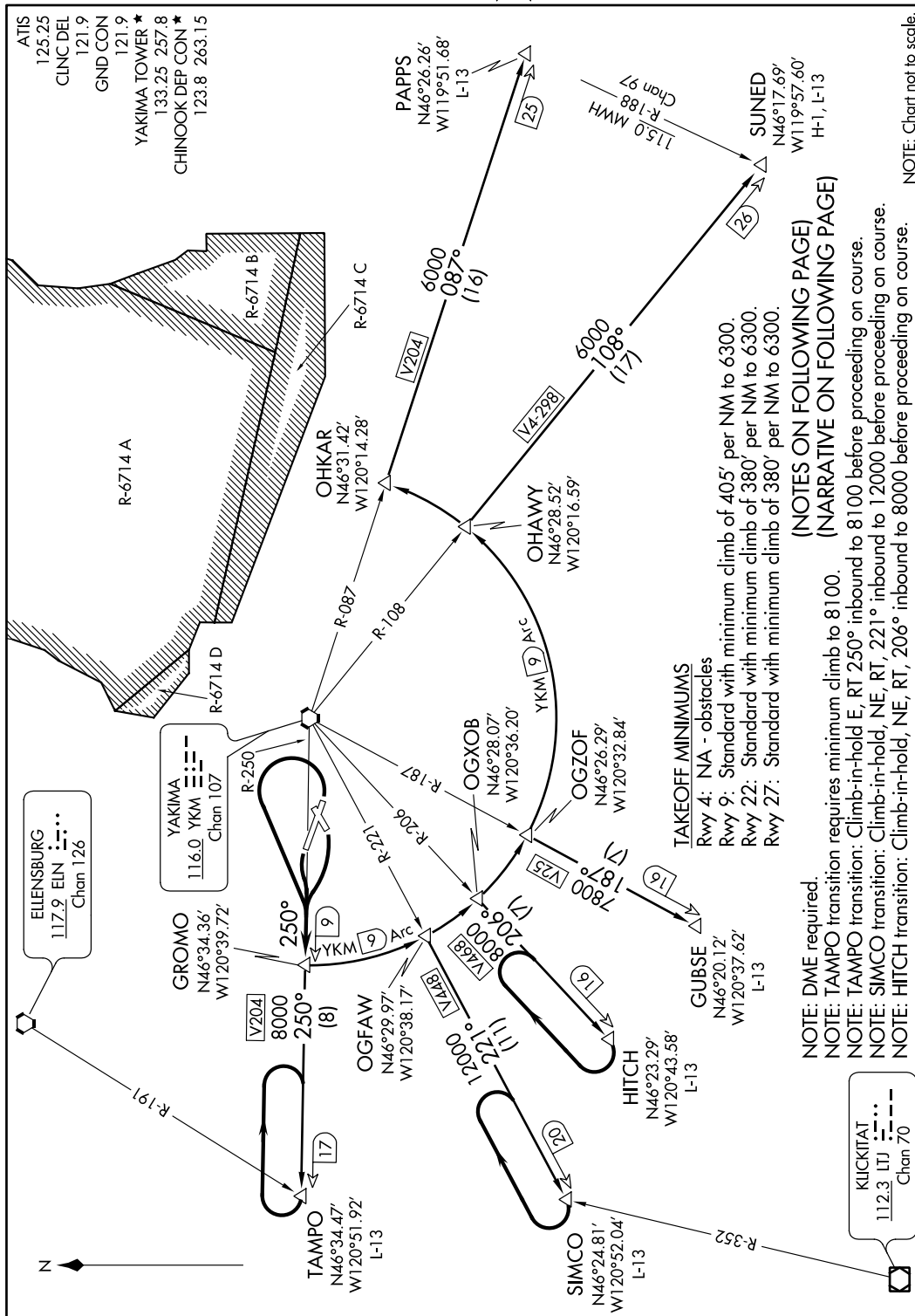

FIGURE 181.—Excerpt from Chart Supplement.

(GROMO3.GROMO) 12320  
**GROMO THREE DEPARTURE**

YAKIMA AIR TERMINAL/MCALLISTER FIELD (YKM)  
 SL-465 (FAA) YAKIMA, WASHINGTON



**GROMO THREE DEPARTURE**  
 (GROMO3.GROMO) 12320

YAKIMA, WASHINGTON  
 YAKIMA AIR TERMINAL/MCALLISTER FIELD (YKM)

FIGURE 182.—GROMO Three Departure (GROMO3.GROMO).

(GROMO3.GROMO) 12208

GROMO THREE DEPARTURE

YAKIMA AIR TERMINAL/MCALLISTER FIELD (YKM)  
SL-465 (FAA) YAKIMA, WASHINGTON



DEPARTURE ROUTE DESCRIPTION

TAKEOFF RUNWAY 9,27: Climbing left turn thence. . . .

TAKEOFF RUNWAY 22: Climbing right turn thence. . . .

. . . . intercept and proceed via YKM R-250 to GROMO/YKM 9 DME,  
then on assigned transition.

GUBSE TRANSITION (GROMO3.GUBSE): From over GROMO DME Fix via YKM 9 DME  
Arc to OGZOF DME fix and YKM VORTAC R-187 to GUBSE DME fix.

HITCH TRANSITION (GROMO3.HITCH): From over GROMO DME Fix via YKM 9 DME  
Arc to OGXOB DME fix and YKM VORTAC R-206 to HITCH DME fix.

PAPPS TRANSITION (GROMO3.PAPPS): From over GROMO DME Fix via YKM 9 DME  
Arc to OKHAR DME fix and YKM VORTAC R-087 to PAPPS DME fix.

SIMCO TRANSITION (GROMO3.SIMCO): From over GROMO DME Fix via YKM 9 DME  
Arc to OGFOW DME fix and YKM VORTAC R-221 to SIMCO INT.

SUNED TRANSITION (GROMO3.SUNED): From over GROMO DME Fix via 9 DME  
Arc to OHAWY DME fix and KM R-108 to SUNED INT.

TAMPO TRANSITION (GROMO3.TAMPO): From over GROMO DME Fix via  
YKM VORTAC R-250 to TAMPO INT.

TAKEOFF OBSTACLE NOTES

Rwy 9: OL on building 27' from DER, 507' right of centerline, 34' AGL/1074' MSL.

Pole 388' from DER, 561' right of centerline, 34' AGL/1073' MSL.

Trees beginning 586' from DER, 550' right of centerline, up to 100' AGL/1139' MSL.

Rwy 22: Fence beginning 27' from DER, 435' right of centerline, up to 10' AGL/1085' MSL.

Trees beginning 570' from DER, 228' left of centerline, up to 100' AGL/1199' MSL.

Trees beginning 3195' from DER, 202' right of centerline, up to 100' AGL/1199' MSL.

Trees beginning 1 NM from DER, 732' left of centerline, up to 100' AGL/1239' MSL.

Rwy 27: Ant on building 398' from DER, 282' left of centerline, 15' AGL/1117' MSL.

Trees beginning 3893' from DER, 1341' right of centerline, up to 100' AGL/1239' MSL.

GROMO THREE DEPARTURE

(GROMO3.GROMO) 12208

YAKIMA AIR TERMINAL/MCALLISTER FIELD (YKM)  
YAKIMA, WASHINGTON

FIGURE 183.—GROMO Three Departure (GROMO3.GROMO).



200

## WASHINGTON

**YAKIMA AIR TERMINAL/MCALLISTER FLD** (YKM) 3 S UTC-8(-7DT) N46°34.09' W120°32.64' SEATTLE  
 1099 B S4 FUEL 100LL, JET A OX 1, 3 Class I, ARFF Index A NOTAM FILE YKM H-1C, L-13A  
**RWY 09-27:** H7604X150 (ASPH-GRVD) S-95, D-160, 2S-175, 2D-220, 2D/2D2-550 PCN 33 F/C/X/T IAP, DIAP AD  
 HIRL 0.7% up W  
**RWY 09:** REIL. VASI(V4L)—GA 3.0° TCH 50'.  
**RWY 27:** MALSR. PAPI(P4L)—GA 3.0° TCH 57'.  
**RWY 04-22:** H3835X150 (ASPH-PFC) S-70, D-80, 2S-102, 2D-120 PCN 28 F/C/X/T MIRL 0.5% up SW  
**RWY 04:** REIL. PAPI(P4L)—GA 3.0° TCH 57'.  
**RWY 22:** REIL. PAPI(P4L)—GA 3.0° TCH 45'.  
**RUNWAY DECLARED DISTANCE INFORMATION**  
**RWY 04:** TORA-3835 TODA-3835 ASDA-3835 LDA-3835  
**RWY 09:** TORA-7604 TODA-7604 ASDA-7604 LDA-7604  
**RWY 22:** TORA-3835 TODA-3835 ASDA-3535 LDA-3835  
**RWY 27:** TORA-7604 TODA-7604 ASDA-7604 LDA-7604  
**AIRPORT REMARKS:** Attended 1400-0400Z†. Sfc conditions unmonitored 0800-1330Z†. Be alert, birds invof Yakima River 5  
 NM east of apch to Rwy 27. Reflectors on Twy C only. Rwy 04-22 some spalling and raveling. PPR for unscheduled air  
 carrier ops with more than 30 passenger seats, call arpt manger 509-575-6149/6150. Twy B from apch end of Rwy 22  
 to Twy A rstd to acft with wingspans 79' or less. MIRL Rwy 04-22, REIL Rwy 04 and Rwy 22, PAPI Rwy 04 and Rwy  
 22 OTS when twr clsd. Twy B1 and Twy B2 twy lgts OTS when twr clsd. Twy B lgts south of Rwy 09-27 OTS when twr  
 clsd. When twr clsd ACTIVATE HIRL Rwy 09-27 and MALSR Rwy 27—CTAF.  
**WEATHER DATA SOURCES:** ASOS (509) 248-1502  
**COMMUNICATIONS:** CTAF 133.25 ATIS 125.25 UNICOM 122.95  
 RCO 122.5 (SEATTLE RADIO)  
 Ⓡ CHINOOK APP/DEP CON 123.8 (1400-0600Z†)  
 Ⓡ SEATTLE CENTER APP/DEP CON 132.6 (0600-1400Z†)  
 TOWER 133.25 (1400-0600Z†) GND CON 121.9 CLNC DEL 121.9  
**AIRSPACE:** CLASS D svc 1400-0600Z† other times CLASS E.  
**RADIO AIDS TO NAVIGATION:** NOTAM FILE YKM.  
 (H) VORTACW 116.0 YKM Chan 107 N46°34.21' W120°26.68' 247° 4.1 NM to fld. 984/21E.  
 DME unusable:  
 095°-115° byd 26 NM blo 8,000'  
 095°-115° byd 35 NM  
 115°-207° byd 20 NM blo 8,500'  
 115°-207° byd 36 NM blo 10,000'  
 207°-230° byd 20 NM blo 10,000'  
 290°-315° byd 20 NM blo 11,000'  
 315°-080° byd 12 NM blo 15,000'  
 VOR portion unusable:  
 025°-035° byd 5 NM blo 6,000'  
 080°-105° byd 35 NM blo 6,000'  
 105°-107° byd 25 NM blo 6,000'  
 109°-135° byd 25 NM blo 6,000'  
 135°-180° byd 30 NM blo 7,500'  
 195°-225° byd 30 NM blo 8,500'  
 305°-335° byd 30 NM blo 9,000'  
 350°-080° byd 25 NM blo 9,000'  
**DONNY NDB (LOM)** 371 YK N46°31.54' W120°22.33' 274° 7.6 NM to fld. Unmonitored when ATCT closed.  
**ILS 110.1** I-YKM Rwy 27. LOM DONNY NDB. Unmonitored when ATCT closed.  
**COMM/NAV/WEATHER REMARKS:** During hrs twr is clsd all ops in vicinity of arpt rstd to acft with VHF radio capability, unless an  
 emerg exist necessitating UHF equipped acft to land.

FIGURE 184.—Excerpt from Chart Supplement.

13290

# AIRPORT DIAGRAM

AL-330 (FAA)

PORTLAND INTL (PDX)  
PORTLAND, OREGON

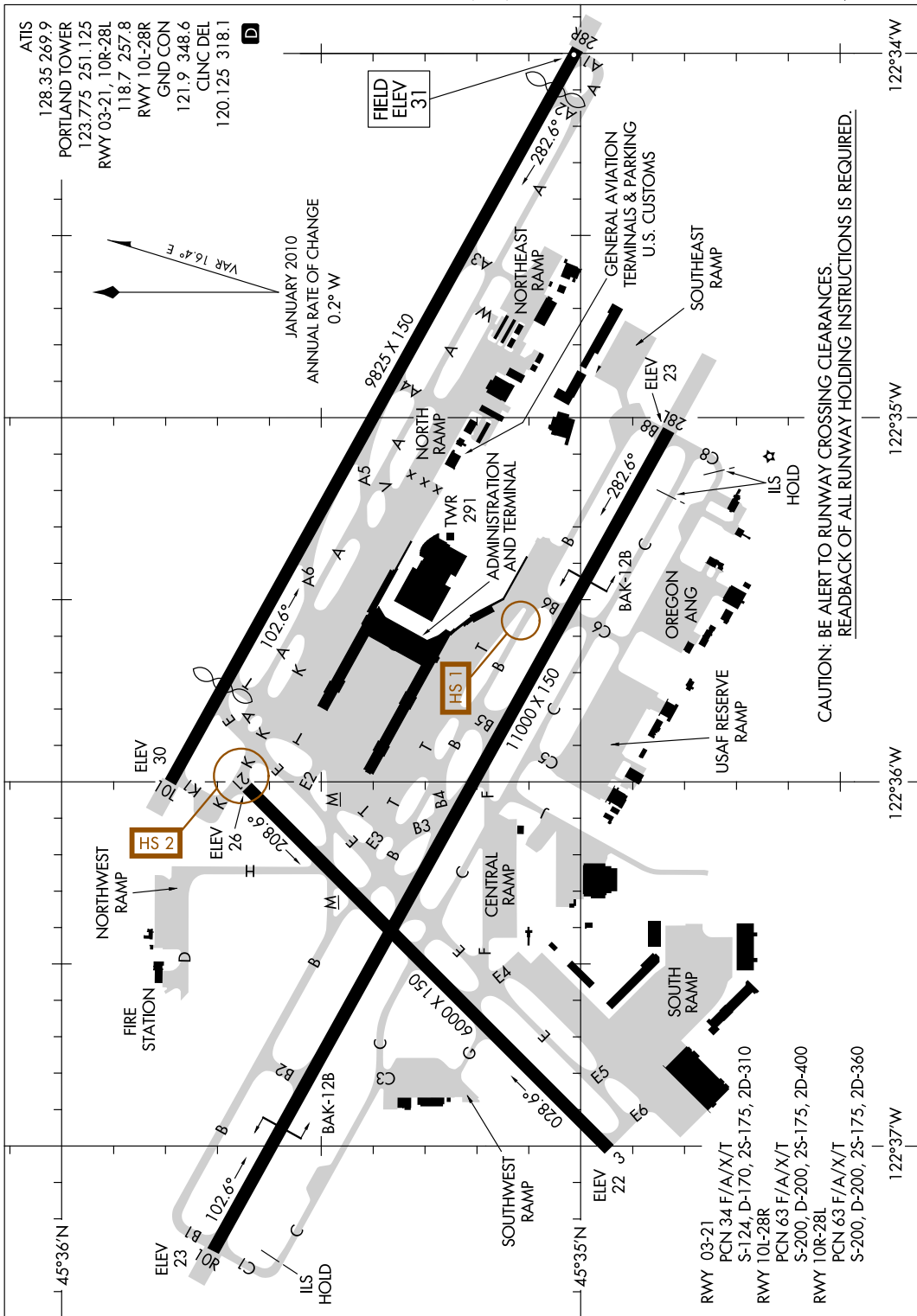

# AIRPORT DIAGRAM

PORTLAND, OREGON  
PORTLAND INTL (PDX)

13290

FIGURE 185.—Airport Diagram - Portland INTL (PDX).

PORTLAND, OREGON

AL-330 (FAA)

12264

LOC/DME I-PDX <b>110.5</b> Chan <b>42</b>	APP CRS <b>103°</b>	Rwy Idg <b>11000</b> <b>THRE 23</b> Apt Elev <b>31</b>	10R <b>8535</b> <b>30</b> <b>31</b>
---	------------------------	--	--

## ILS or LOC RWY 10R PORTLAND INTL (PDX)

▼ For inop ALSF-2 increase S-ILS 10R visibility all Cats to RVR 4000.  
▲ For inop ALSF-2 increase S-LOC 10R Cats C-E visibility to 2 1/2.  
▲ For inop ALSF-2 increase JADNU fix minimums S-LOC 10R Cat C-E visibility to RVR 6000. Sidestep NA until passing JADNU.  
 Inop table does not apply to Sidestep LOC. Simultaneous approach authorized with Rwy 10L

ALSF-2 Rwy 10R	MALSR Rwy 10L	MISSED APPROACH: Climb to 1100 then climbing right turn to 5000 on BTG VORTAC R-160 to MULES INT/BTG 17.7 DME and hold, continue climb-in-hold to 5000.
-------------------	------------------	---

ATIS <b>128.35 269.9</b>	PORTLAND APP CON <b>124.35 299.2</b>	PORTLAND TOWER Rwy 10L-28R <b>118.7 257.8</b>	Rwys 3-21, 10R-28L <b>123.775 251.125</b>	GND CON <b>121.9 348.6</b>	CLNC DEL <b>120.125 318.1</b>
-----------------------------	---	---	--	-------------------------------	----------------------------------

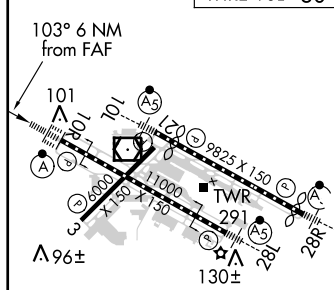
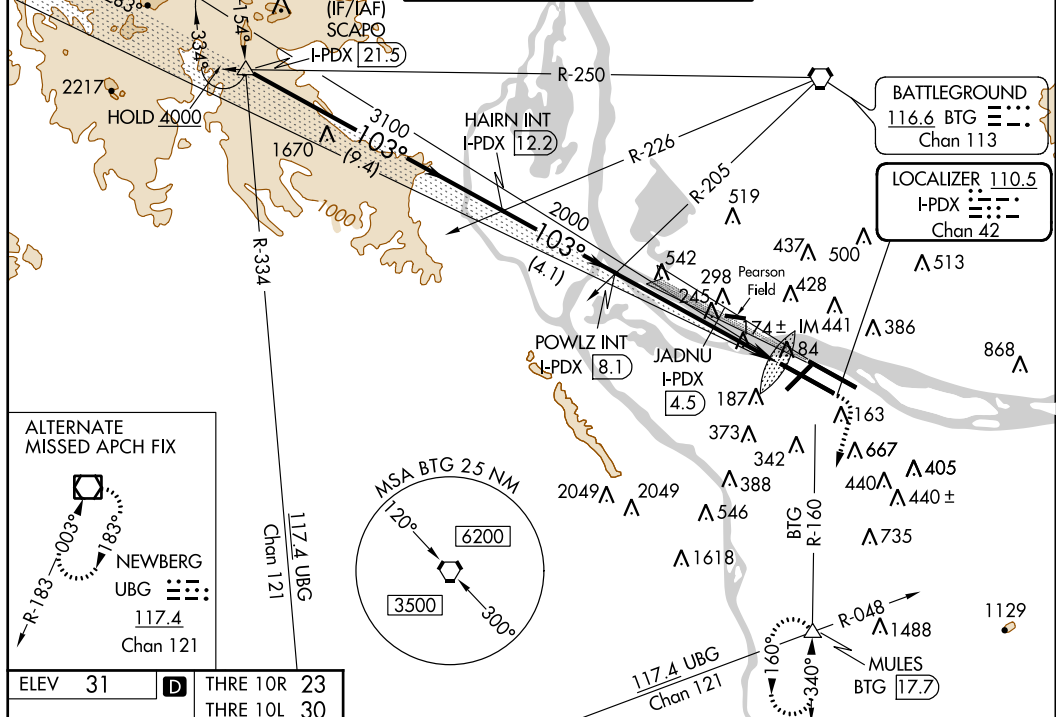

SCAPO I-PDX [21.5]	HAIRN INT I-PDX [12.2]	POWLZ INT I-PDX [8.1]	JADNU I-PDX [4.5]	1100	5000	MULES BTG R-160
4000	3100	2000	2000	*I-PDX [3.1]	I-PDX [2]	*LOC only
VGSI and ILS glidepath not coincident (VGSI Angle 3.00/TCH 71).						
9.4 NM    4.1 NM    3.6 NM    1.4 NM    1 NM    0.1 NM						

CATEGORY	A	B	C	D	E
S-ILS 10R	223/18 200 (200-1/2)				
S-LOC 10R	860/24 837 (900-1/2)	860/40 837 (900-3/4)	860-1 7/8		837 (900-1 7/8)
CIRCLING	860-1 1/4	829 (900-1 1/4)	860-2 1/2 829 (900-2 1/2)	949 (1000-3)	1140-3 1109 (1200-3)
JADNU FIX MINIMUMS					
S-LOC 10R	440/24 417 (500-1/2)		440/40 417 (500-3/4)		
SIDESTEP 10L	800-1 770 (800-1)	800-1 1/4 770 (800-1 1/4)	800-2 1/2	770 (800-2 1/2)	800-3 770 (800-3)

REIL Rwys 3 and 21  
 TDZ/CL Rwy 10R  
 MIRL Rwy 3-21  
 HIRL Rwys 10L-28R and 10R-28L

FAF to MAP 6 NM					
Knots	60	90	120	150	180
Min:Sec	6:00	4:00	3:00	2:24	2:00

PORTLAND, OREGON  
 Amdt 34B 20SEP12

45°35'N-122°36'W

## PORTLAND INTL (PDX) ILS or LOC RWY 10R

FIGURE 186.—ILS or LOC RWY 10R (PDX).

PORTLAND, OREGON

AL-330 (FAA)

13122

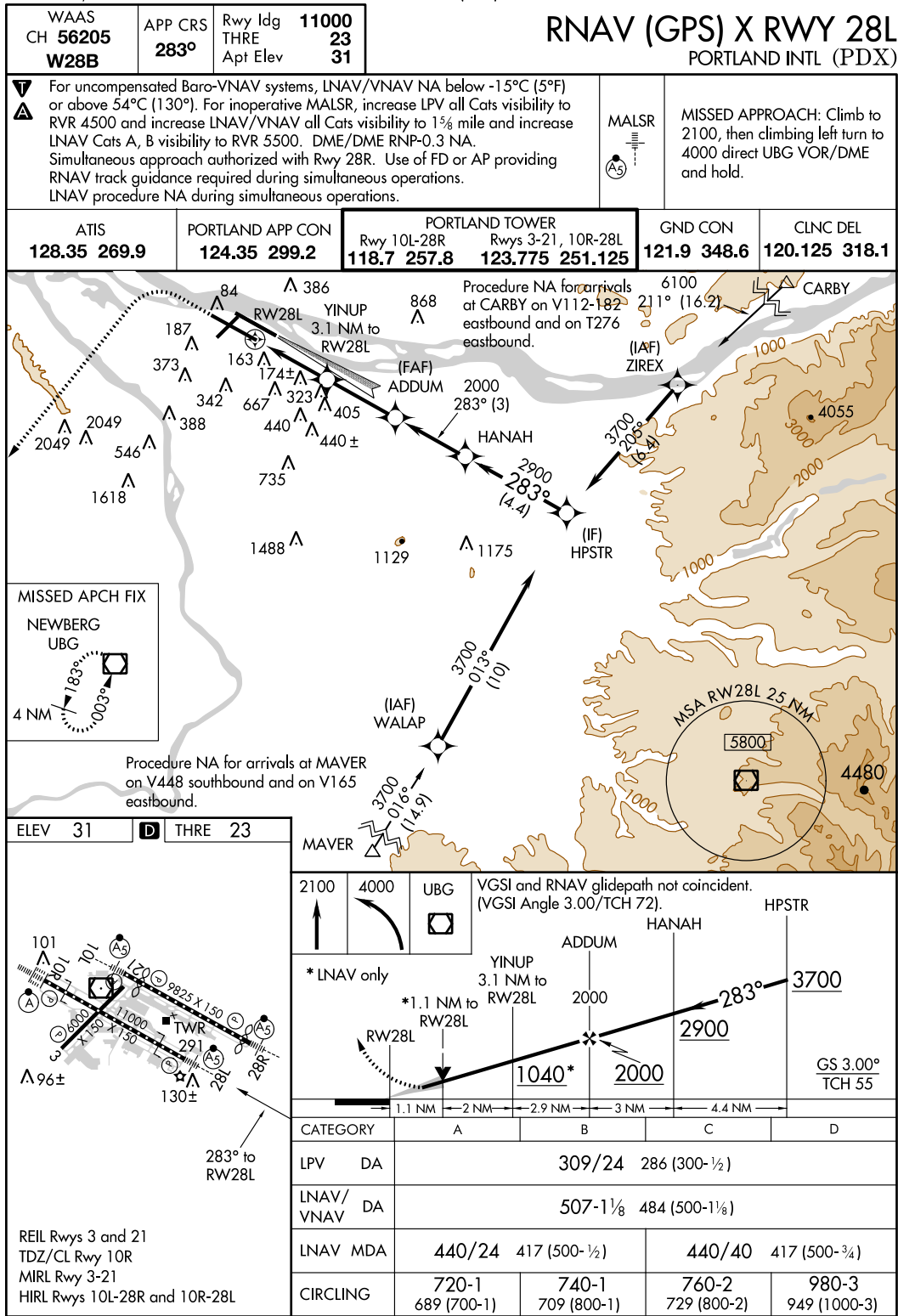

PORTLAND, OREGON

PORTLAND INTL (PDX)

Amdt 2 20SEP12

45°35'N-122°36'W

**RNAV (GPS) X RWY 28L**

FIGURE 187.—RNAV (GPS) X RWY 28L (PDX).

PORTLAND, OREGON

AL-330 (FAA)

13122

LOC/DME I-GPO <b>108.9</b> Chan <b>26</b>	APP CRS <b>209°</b>	Rwy Idg THRE Apt Elev <b>6000</b> <b>26</b> <b>31</b>
---	------------------------	--

**LOC/DME RWY 21**  
PORTLAND INTL (PDX)

**▽** Helicopter visibility reduction below 3/4 SM NA.  
**▲** MISSED APPROACH: Climbing right turn to 4200 on BTG VORTAC R-160 to BTG VORTAC and hold, continue climb-in-hold to 4200.

ATIS <b>128.35 269.9</b>	PORTLAND APP CON <b>124.35 299.2</b>	PORTLAND TOWER Rwys 10L-28R <b>118.7 257.8</b>	Rwys 3-21, 10R-28L <b>123.775 251.125</b>	GND CON <b>121.9 348.6</b>	CLNC DEL <b>120.125 318.1</b>
-----------------------------	---	--	--	-------------------------------	----------------------------------

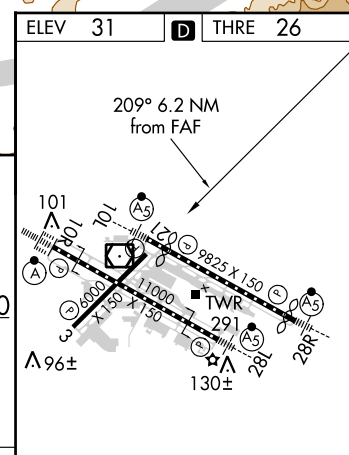
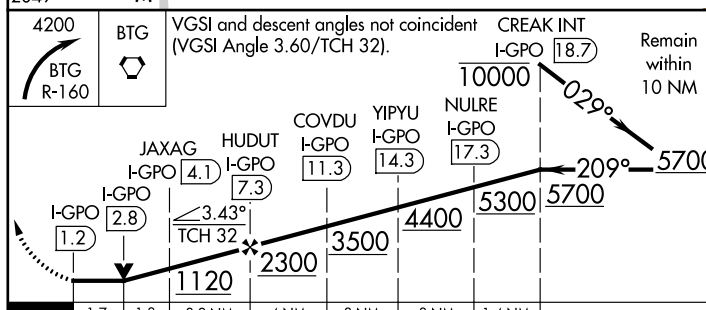
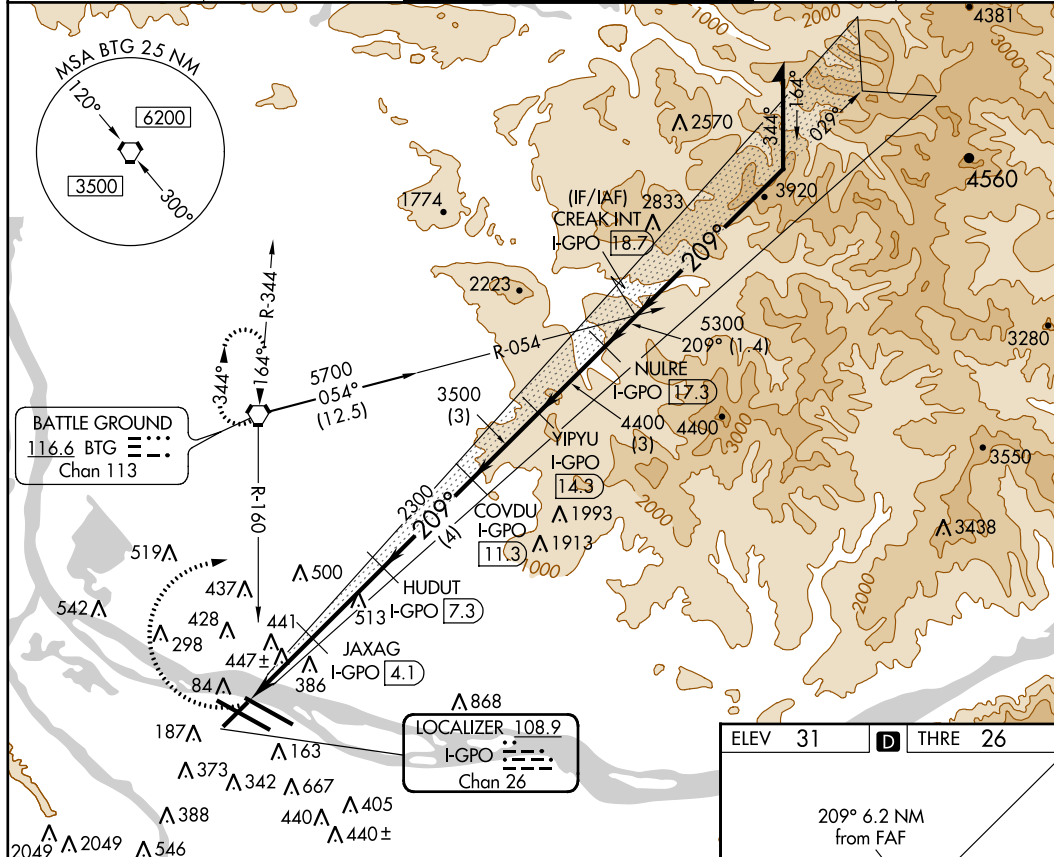

4200	BTG	VGSI and descent angles not coincident (VGSI Angle 3.60/TCH 32).		CREAK INT I-GPO (18.7)	Remain within 10 NM
BTG R-160					
		JAXAG I-GPO (4.1)	HUDUT I-GPO (7.3)	COVDU I-GPO (11.3)	YIPYU I-GPO (14.3)
		I-GPO (2.8)			NULRE I-GPO (17.3)
		1.7	1.3	3.2 NM	4 NM
CATEGORY		A	B	C	D
S-21		700-1	674 (700-1)	700-1 7/8	674 (700-1 7/8)
CIRCLING		720-1	740-1	760-2	1000-3
		689 (700-1)	709 (800-1)	729 (800-2)	969 (1000-3)

REIL Rws 3 and 21  
TDZ/CL Rwy 10R  
MIRL Rwy 3-21  
HIRL Rws 10L-28R and 10R-28L

PORTLAND, OREGON  
Amdt 8B 02MAY13

45°35'N-122°36'W

**PORTLAND INTL (PDX)**  
**LOC/DME RWY 21**

FIGURE 188.—LOC/DME RWY 21 (PDX).

Appendix 2

(HABUT4.GVO) 13122

HABUT FOUR DEPARTURE

SL-378 (FAA)

SANTA BARBARA MUNI (SBA)

SANTA BARBARA, CALIFORNIA

ATIS 132.65  
 CLNC DEL  
 132.9  
 GND CON  
 121.7  
 SANTA BARBARA TOWER\*  
 119.7 (CTAF) 254.35  
 SANTA BARBARA DEP CON  
 120.55 319.15

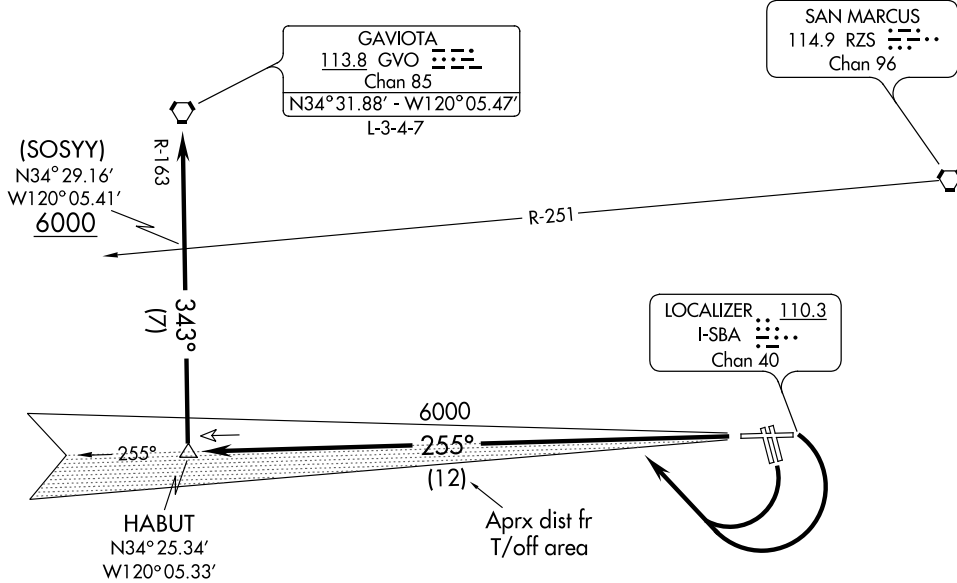

NOTE: IFR departure Rwy 33L/R not authorized.

NOTE: Minimum (ATC) climb of 385' per NM to 6000.

NOTE: Chart not to scale.

DEPARTURE ROUTE DESCRIPTION

TAKE-OFF RUNWAYS 7 and 15L/R: Turn right, intercept I-SBA west course to HABUT INT, thence via GVO R-163 to GVO VORTAC. Cross RZS R-251 at or above 6000'.

TAKE-OFF RUNWAY 25: Intercept I-SBA west course to HABUT INT, thence via GVO R-163 to GVO VORTAC. Cross RZS R-251 at or above 6000'.

HABUT FOUR DEPARTURE

(HABUT4.GVO) 13122

SANTA BARBARA, CALIFORNIA  
 SANTA BARBARA MUNI (SBA)

FIGURE 189.—HABUT Four Departure (HABUT4.GVO) (SBA).

186

## CALIFORNIA

**SANTA BARBARA MUNI** (SBA) 7 W UTC-8(-7DT) N34°25.57' W119°50.49' LOS ANGELES  
 13 B S4 FUEL 100LL, JET A OX 1, 2, 3, 4 TPA—See Remarks LRA Class I, ARFF Index C H-4H, L-3D, 4F, 7A  
 NOTAM FILE SBA IAP, AD

RWY 07-25: H6052X150 (ASPH-PFC) S-110, D-160, 2S-175,  
 2D-245 HIRL

RWY 07: MALS. Tree. Rgt tfc.

RWY 25: REIL. PAPI(P4L)—GA 3.0° TCH 50'. Fence.

RWY 15R-33L: H4184X100 (ASPH) S-48, D-63, 2S-80, 2D-100  
 MIRL

RWY 15R: REIL. Tree.

RWY 33L: Tree. Rgt tfc.

RWY 15L-33R: H4178X75 (ASPH) S-35, D-41, 2S-80, 2D-63

RWY 15L: Thld dspcd 217'. Bldg.

RWY 33R: Rgt tfc.

**AIRPORT REMARKS:** Attended 1330-0600Z. 100LL fuel 24 hr credit card  
 svc avbl. Fee for Jet A fuel after hrs call 805-964-6733 or 967-5608.  
 Numerous flocks of birds on and invof arpt. Deep creek located 300'  
 from rwy end Rwy 07, Rwy 33L and Rwy 33R. Rwy 15L-33R dalgt  
 hrs only. Arpt has noise abatement procedures ctc arpt ops  
 805-692-6005. Due to ltd ramp space at the airline terminal  
 non-scheduled transport category acft with more than 30 passenger  
 seats are required to ctc arpt ops 805-692-6005 24 hour PPR to  
 arrival. Commercial airline ramp clsd to all General Aviation acft. No customs personnel or facilities are avbl and  
 international acft will not be allowed to land unless an emerg exists. TPA—1003(990) small acft, 1503(1490) large acft.  
 Pure jet touch/go or low approaches prohibited. When twr clsd ACTIVATE MIRL Rwy 15R-33L, REIL Rwy 15R—CTAF.  
 MALS. Rwy 07, PAPI Rwy 25 and REIL Rwy 25 opr continuously. CTAF. Ldg fee for all PART 135 opr and transient acft  
 with maximum gross weight 10,000 lbs or more. Fees collected at FBO.

**WEATHER DATA SOURCES:** ASOS (805) 681-0583

**COMMUNICATIONS:** CTAF 119.7 ATIS 132.65 UNICOM 122.95

Ⓡ APP/DEP CON 120.55 (151°-329°) 125.4 (330°-150°) 124.15 127.725 (1400-0700Z)

Ⓡ L.A. CENTER APP/DEP CON 119.05 (0700-1400Z)

TOWER 119.7 (1400-0700Z) GND CON 121.7 CLNC DEL 132.9

**AIRSPACE:** CLASS C svc ctc APP CON svc 1400-0700Z other times CLASS E.

**RADIO AIDS TO NAVIGATION:** NOTAM FILE HHR.

SAN MARCUS (H) VORTAC 114.9 RZS Chan 96 N34°30.57' W119°46.26' 201° 6.1 NM to fld. 3623/14E.  
 HIWAS.

VOR unusable:

140°-178° byd 27 NM

GAVIOTA (L) VORTACW 113.8 GVO Chan 85 N34°31.88' W120°05.47' 101° 13.9 NM to fld. 2616/16E.

VORTAC unusable:

117°-137° byd 35 NM

310°-095° byd 10 NM blo 8,500'

360°-095° byd 20 NM blo 12,500'

ILS/DME 110.3 I-SBA Chan 40 Rwy 07. Class IA. Unmonitored when ATCT clsd.

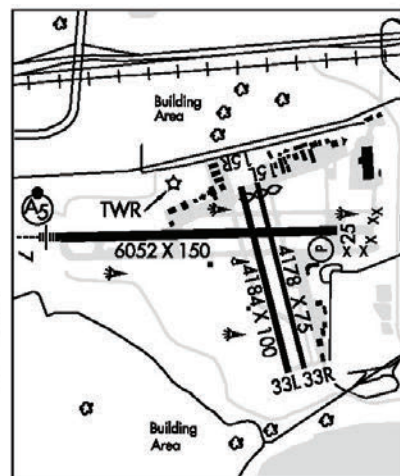

**SANTA CATALINA** N33°22.50' W118°25.19' NOTAM FILE HHR. LOS ANGELES  
 (L) VORTACW 111.4 SXC Chan 51 352° 1.8 NM to Catalina. 2090/15E. H-4I, L-3E, 4G

FIGURE 190.—Excerpt from Chart Supplement.

PASO ROBLES, CALIFORNIA

AL-858 (FAA)

11069

WAAS CH <b>65819</b> <b>W19A</b>	APP CRS <b>194°</b>	Rwy Idg TDZE Apt Elev	<b>6008</b> <b>804</b> <b>840</b>
--	------------------------	-----------------------------	---

# RNAV (GPS) RWY 19

PASO ROBLES MUNI (PRB)

**⚠** For uncompensated Baro-VNAV systems, LNAV/VNAV NA below -16°C (4°F) or above 38°C (100°F). DME/DME RNP-0.3 NA.  
**⚠** When local altimeter setting not received, procedure NA.

**MISSED APPROACH:** Climb to 1800 then climbing left turn to 6500 direct NEFDE and hold, continue climb-in-hold to 6500.

ASOS <b>120.125</b>	OAKLAND CENTER <b>128.7 307.0</b>	UNICOM <b>123.0 (CTAF) 0</b>
------------------------	--------------------------------------	---------------------------------

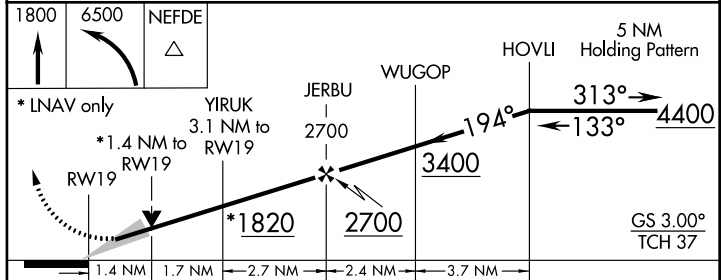
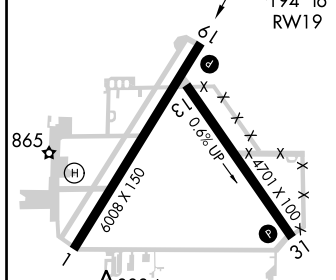
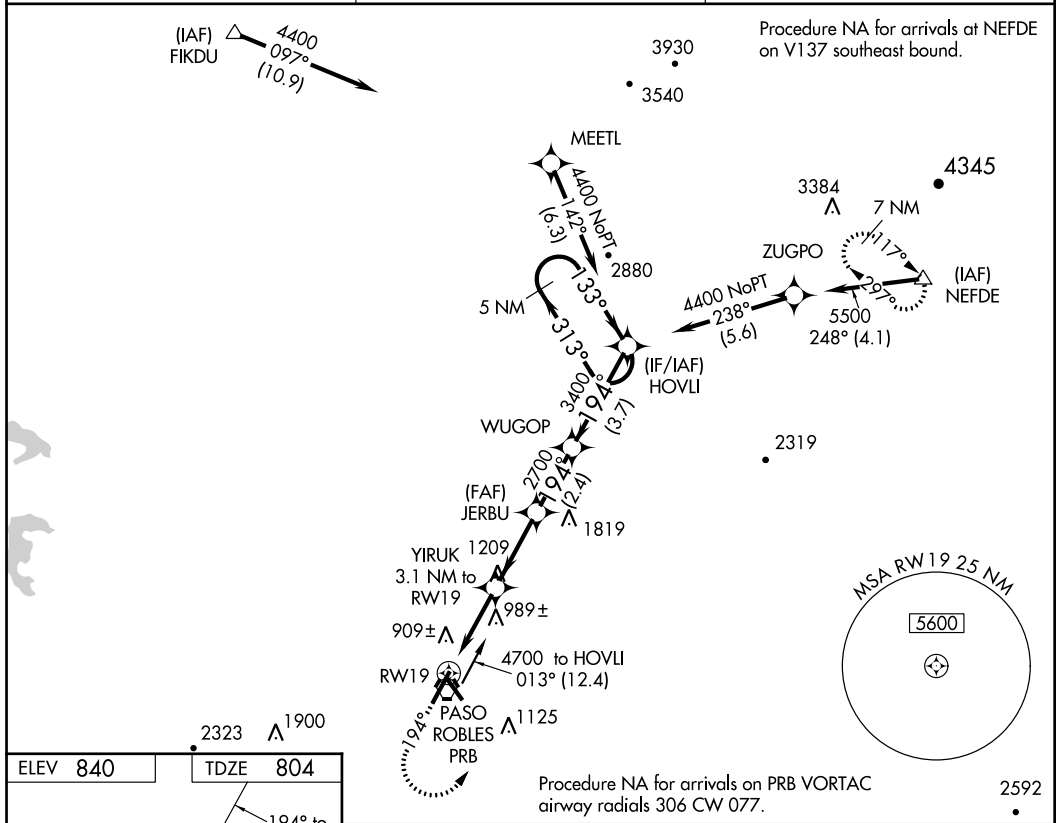

CATEGORY	A	B	C	D
LPV DA		1004-3/4	200 (200-3/4)	
LNAV/VNAV DA		1190-1 3/8	386 (400-3/8)	
LNAV MDA	1300-1	496 (500-1)	1300-1 3/8	496 (500-1 3/8)
CIRCLING	1300-1	460 (500-1)	1340-1 1/2 500 (500-1 1/2)	1560-2 1/4 720 (800-2 1/4)

PASO ROBLES, CALIFORNIA  
Amdt 1 13JAN11

35°40'N-120°38'W

# PASO ROBLES MUNI (PRB)

## RNAV (GPS) RWY 19

FIGURE 191.—RNAV (GPS) RWY 19 (PRB).



PASO ROBLES, CALIFORNIA

AL-858 (FAA)

11069

VORTAC PRB <b>114.3</b> Chan <b>90</b>	APP CRS <b>313°</b>	Rwy Idg TDZE Apt Elev <b>N/A</b> <b>N/A</b> <b>840</b>
--	------------------------	---

**VOR/DME-B**  
PASO ROBLES MUNI (PRB)

▲  
▲ MISSED APPROACH: Climbing right turn to 4700 in PRB VORTAC holding pattern.

ASOS <b>120.125</b>	OAKLAND CENTER <b>128.7 307.0</b>	UNICOM <b>123.0 (CTAF) 0</b>
------------------------	--------------------------------------	---------------------------------

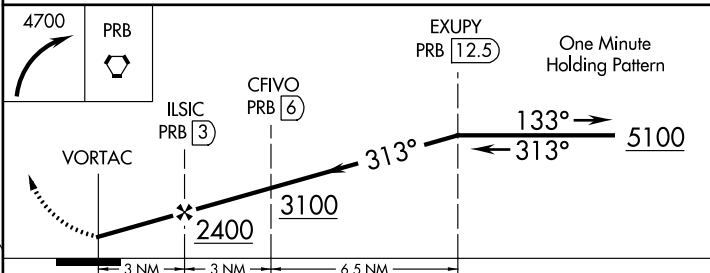
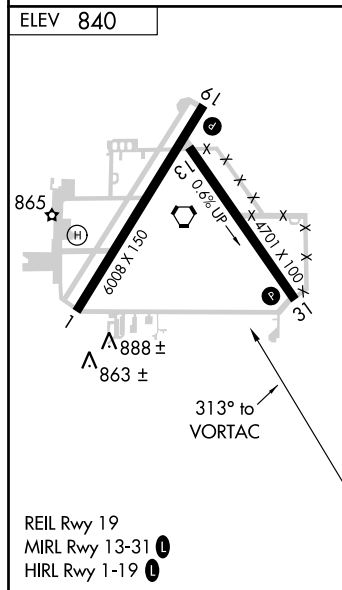
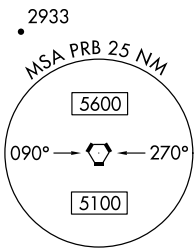
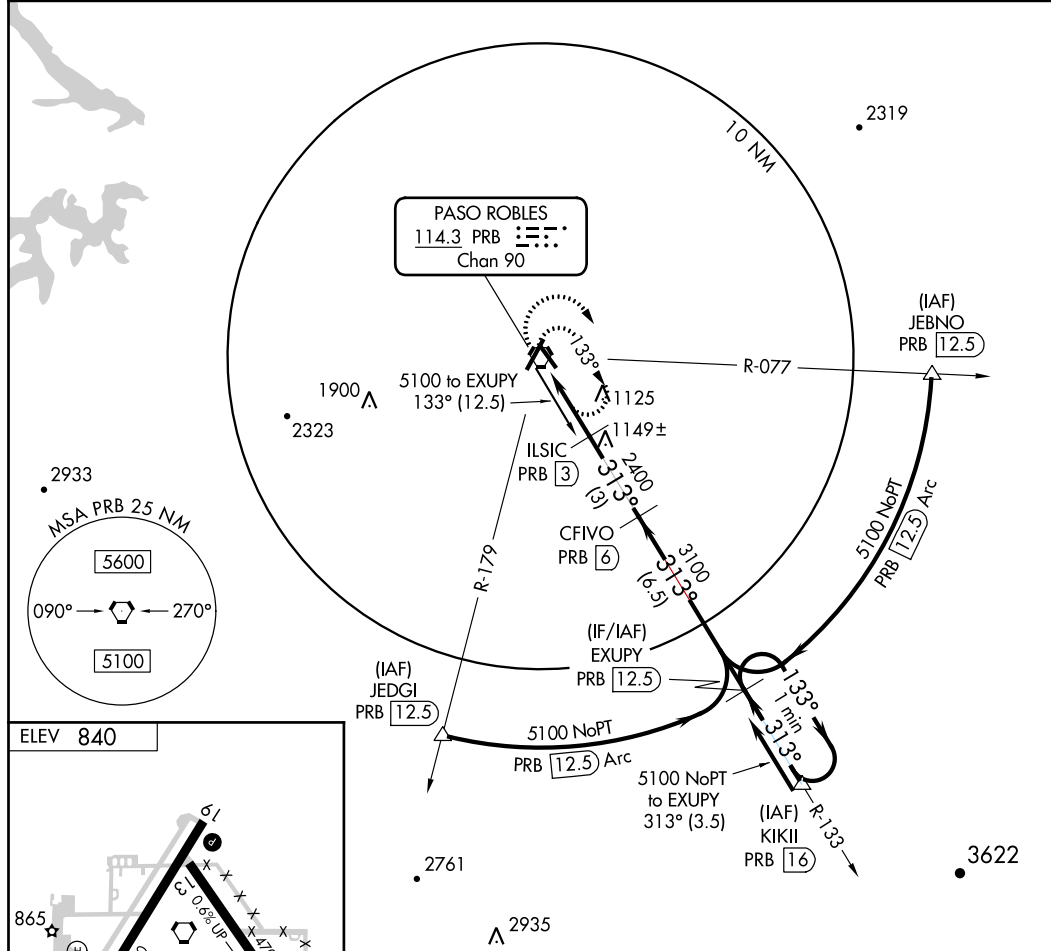

CATEGORY	A	B	C	D
CIRCLING	1560-1	720 (800-1)	1560-2 720 (800-2)	1560-2¼ 720 (800-2¼)

PASO ROBLES, CALIFORNIA  
Amdt 3 23SEP10

35°40'N-120°38'W

PASO ROBLES MUNI (PRB)  
**VOR/DME-B**

FIGURE 192.—VOR/DME-B (PRB).

**COLLEGE STATION**

**EASTERWOOD FLD** (CLL) 3 SW UTC-6(-5DT) N30°35.32' W96°21.83'

321 B S4 FUEL 100LL, JET A Class I, ARFF Index A NOTAM FILE CLL

RWY 16-34: H7000X146 (ASPH-CONC-GRVD) S-70, D-90, 2S-114, 2D-150 HIRL

RWY 16: VASI(V4R)—GA 3.0° TCH 51'. Tree.

RWY 34: MALS.R.

RWY 10-28: H5158X150 (ASPH-GRVD) S-27, D-50, 2D-87 MIRL

RWY 10: VASI(V4L)—GA 3.0° TCH 50'. Tree.

RWY 28: REIL. VASI(V4L)—GA 3.0° TCH 54'. Tree.

RWY 04-22: H5150X150 (CONC) S-27, D-50, 2D-87

RWY 04: Tree.

RWY 22: Tree.

**RUNWAY DECLARED DISTANCE INFORMATION**

RWY 04: TORA-5149 TODA-5149 ASDA-5149 LDA-5149

RWY 10: TORA-5159 TODA-5159 ASDA-5159 LDA-5159

RWY 16: TORA-7000 TODA-7000 ASDA-7000 LDA-7000

RWY 22: TORA-5149 TODA-5149 ASDA-5149 LDA-5149

RWY 28: TORA-5159 TODA-5159 ASDA-5159 LDA-5159

RWY 34: TORA-7000 TODA-7000 ASDA-7000 LDA-7000

**AIRPORT REMARKS:** Attended 1200-0400Z. For fuel after hours PPR call

979-845-4811 or ctc Texas A and M University police

979-845-2345; late ngt fee. CLOSED to unscheduled air carrier ops

with more than 30 passenger seats except 24 hours PPR call arpt manager 979-845-4811. Rwy 04-22 day VFR ops

only. Rwy 10-28 mandatory hold short sign on Rwy 16-34 unlgtd. Itinerant acft park in front of twr, overnight parking

fee. Ldg fee scheduled FAR 135 and all FAR 121 ops. Rwy 04-22 and Twy E S of Rwy 10-28 not avbl for air carrier acft

with over 30 passenger seats. Rwy 16-34 first 1850' Rwy 34 conc. PAEW adjacent all twys 1200-2200Z. When twr clsd

ACTIVATE HIRL Rwy 16-34 and MALS.R Rwy 34—CTAF. MIRL Rwy 10-28 and REIL Rwy 28 preset low ints only.

**WEATHER DATA SOURCES:** ASOS (979) 846-1708 HIWAS 113.3 CLL.

**COMMUNICATIONS:** CTAF 118.5 ATIS 126.85 UNICOM 122.95

COLLEGE STATION RCO 122.65 122.2 (MONTGOMERY COUNTY RADIO).

HOUSTON APP/DEP CON 134.3

TOWER 118.5 (1400-0300Z) GND CON/CLNC DEL 128.7 CLNC DEL 120.4 (when twr clsd)

**AIRSPACE:** CLASS D svc 1400-0300Z other times CLASS E.

HOUSTON  
H-7C, L-19D, 21A  
IAP, AD

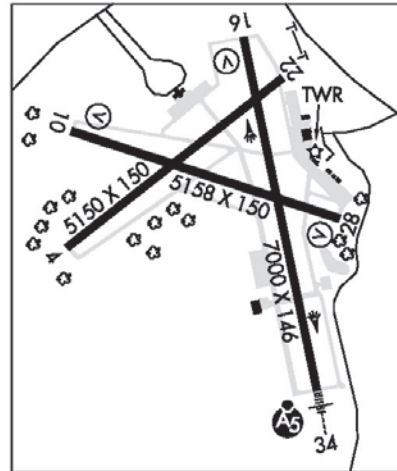

**VOR RECEIVER CHECK**

**TEXAS**

**VOR RECEIVER CHECKPOINTS**

Facility Name (Arpt Name)	Freq/Ident	Type Check Pt. Gnd. AB/ALT	Azimuth from Fac. Mag	Dist. from Fac. N.M.	Checkpoint Description
Abilene (Abilene Rgnl)	113.7/ABI	A/2800	047	10.1	Over silos in center of Ft Phantom Lake.
Alice (Alice International)	114.5/ALI	G	272	0.5	On twy near FBO.
Borger (Hutchinson Co)	108.6/BGD	G	173	6.7	On twy intersection at N end of ramp.
Brownsville (Brownsville/South Padre Island Intl)	116.3/BRO	G	247	3.2	3.2 NM on hold line Rwy 13R.
Brownwood (Brownwood Rgnl)	108.6/BWD	A/2600	169	6.2	Over rotating bcn.
Childress Muni	117.6/CDS	G	353	3.7	At the apron and the twy from Rwy 04-22.
College Station (Easterwood Fld)	113.3/CLL	G	97	3.2	On west edge of parking ramp.
Corpus Christi (Alfred C 'Bubba' Thomas)	115.5/CRP	A/1000	318	9.3	Over Rwy 32 thld.
Corpus Christi (Corpus Christi Intl)	115.5/CRP	A/1100	187	7.5	Over grain elevator.
Daisetta (Liberty Muni)	116.9/DAS	A/1200	195	7.5	Over hangar S of arpt.
Dalhart (Dalhart Muni)	112.0/DHT	A/5000	176	4.1	Over water tower on arpt.
Eagle Lake (Eagle Lake)	116.4/ELA	A/1200	180	4.1	Over water tank 0.4 NM SW of arpt.

FIGURE 193.—Excerpts from Chart Supplement.

232

TEXAS

CONTINUED FROM PRECEDING PAGE

RADIO AIDS TO NAVIGATION: NOTAM FILE CLL.

COLLEGE STATION (L) VORTACW 113.3 CLL Chan 80 N30°36.30' W96°25.24' 100° 3.1 NM to fld. 264/8E. HIWAS.

DME unusable:

- 101°-130° byd 25 NM blo 2,500'
- 131°-148° byd 30 NM blo 2,500'
- 149°-160° byd 30 NM blo 2,000'
- 325°-349° byd 30 NM blo 2,500'
- 350°-100° byd 25 NM blo 3,500'

VOR portion unusable:

- 131°-189° blo 7,000'

ROWDY NDB (LOM) 260 CL N30°29.62' W96°20.26' 341° 5.8 NM to fld. Unmonitored when ATCT clsd.

ILS/DME 111.7 I-CLL Chan 54 Rwy 34. Class IB. LOM ROWDY NDB. Unmonitored when ATCT clsd. DME unmonitored. Glideslope unusable for coupled apchs blo 1,050' MSL.

COLLIN CO RGNL AT MC KINNEY (See DALLAS on page 241)

COLLINSVILLE

SUDDEN STOP (T32) 1 NE UTC-6(-5DT) N33°34.29' W96°54.43'

DALLAS-FT WORTH

720 NOTAM FILE FTW

RWY 17-35: 1550X60 (TURF)

RWY 17: Trees.

RWY 35: Road.

AIRPORT REMARKS: Attended continuously. Student training prohibited.

COMMUNICATIONS: CTAF 122.9

COLORADO CITY (T88) 6 NW UTC-6(-5DT) N32°28.11' W100°55.27'

DALLAS-FT WORTH

2214 B NOTAM FILE FTW

H-6G, L-17A

RWY 17-35: H5479X60 (ASPH) S-50 LIRL

RWY 35: Tree.

AIRPORT REMARKS: Attended irregularly. Rwy 17-35 pavement from Rwy 35 thld lgts southward used as a twy and not maintained.

COMMUNICATIONS: CTAF 122.9

RADIO AIDS TO NAVIGATION: NOTAM FILE BPG.

BIG SPRING (L) VORTACW 114.3 BGS Chan 90 N32°23.14' W101°29.02' 069° 29.0 NM to fld. 2670/11E.

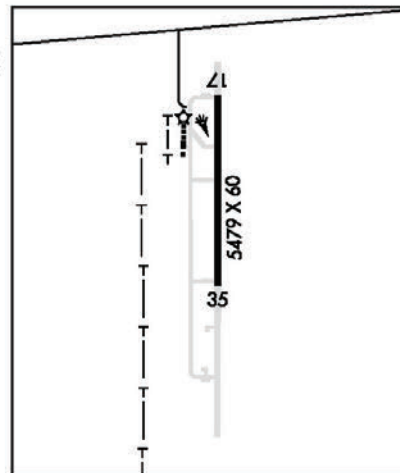

COLUMBUS

ROBERT R WELLS JR (66R) 3 S UTC-6(-5DT) N29°38.49' W96°30.96'

HOUSTON

242 B FUEL 100LL, JET A NOTAM FILE CXO

L-19D, 21A

RWY 15-33: H3800X60 (ASPH) S-12.5 MIRL

RWY 15: REIL. PAPI(P2L). Thld dspcd 305'. Fence.

RWY 33: REIL. PAPI(P2L). Thld dspcd 177'. Brush.

AIRPORT REMARKS: Unattended. Self svc fuel with major credit card. Ultra-light activity on and invof arpt. Rwy 33 REIL OTS indef. ACTIVATE MIRL Rwy 15-33-CTAF.

COMMUNICATIONS: CTAF 122.9

RADIO AIDS TO NAVIGATION: NOTAM FILE CXO.

INDUSTRY (L) VORTACW 110.2 IDU Chan 39 N29°57.36' W96°33.73' 165° 19.0 NM to fld. 419/8E.

FIGURE 194.—Excerpts from Chart Supplement.

**WESTHEIMER AIR PARK** (H07) 20 W UTC-6(-5DT) N29°41.68' W95°47.68' HOUSTON  
 117 B S2 FUEL 100LL NOTAM FILE CXO  
 RWY 11-29: H2500X28 (CONC) LIRL  
 RWY 11: Trees.  
 RWY 29: Tree.  
 AIRPORT REMARKS: Attended 1400-0000Z. 90' P-line 1500' from Rwy 11 thld. Grass in cracks on rwy sfc. ACTIVATE rotating bcn—CTAF. ACTIVATE LIRL Rwy 11-29—CTAF.  
 COMMUNICATIONS: CTAF/UNICOM 122.7

**WILLIAM P HOBBY** (HOU) 8 SE UTC-6(-5DT) N29°38.73' W95°16.73' HOUSTON  
 46 B S2 FUEL 100LL, JET A, A1 OX 1, 2, 3, 4 LRA Class I, ARFF Index C HOUSTON  
 NOTAM FILE HOU COPTER  
 H-7C, L-19E, 21A, GOMW  
 IAP, AD  
 RWY 04-22: H7602X150 (CONC-GRVD) S-75, D-200, 2S-168,  
 2T-461, 2D-400, 2D/D1-444, C5-717 HIRL CL  
 RWY 04: ALSF2. TDZL. PAPI(P4R)—GA 3.0° TCH 57'.  
 RWY 22: MALS. VASI(V4L)—GA 3.0° TCH 52'. Pole.  
 RWY 12R-30L: H7602X150 (ASPH-GRVD) S-75, D-195, 2S-168,  
 2T-461, 2D-220, 2D/D1-444, C5-717 HIRL CL  
 RWY 12R: MALS. TDZL. PAPI(P4R)—GA 3.0° TCH 52'. Thld dspcd  
 1034'. Pole.  
 RWY 30L: TDZL. REIL. PAPI(P4L)—GA 3.0° TCH 71'. Road.  
 RWY 17-35: H6000X150 (ASPH-CONC-GRVD) S-75, D-121, 2S-153,  
 2D-195 MIRL  
 RWY 17: VASI(V4L)—GA 3.0° TCH 38'. Antenna.  
 RWY 35: REIL. VASI(V4R)—GA 3.0° TCH 41'. Bldg.  
 RWY 12L-30R: H5148X100 (CONC-GRVD) S-30, D-45, 2D-80 MIRL  
 RWY 12L: PAPI(P4L)—GA 3.0° TCH 60'.

**RUNWAY DECLARED DISTANCE INFORMATION**

RWY 04: TORA-7602	TODA-7602	ASDA-7602	LDA-7602
RWY 12L:TORA-5148	TODA-5148	ASDA-5148	LDA-5148
RWY 12R:TORA-7602	TODA-7602	ASDA-7602	LDA-6568
RWY 17: TORA-6000	TODA-6000	ASDA-6000	LDA-6000
RWY 22: TORA-7602	TODA-7602	ASDA-7602	LDA-7602
RWY 30L:TORA-7602	TODA-7602	ASDA-7602	LDA-7602
RWY 30R:TORA-5148	TODA-5148	ASDA-5148	LDA-5148
RWY 35: TORA-6000	TODA-6000	ASDA-6000	LDA-6000

AIRPORT REMARKS: Attended continuously. Arpt CLOSED to acft with wingspan over 125' except 24 hours PPR, call arpt manager 713-640-3000. Numerous birds on and invof arpt. ASDE-X Surveillance System in use: pilots should operate transponders with Mode C on all twys and rwys. Customs ramp has multiple obstructions, recommend large acft use customs overflow ramp. Acft in tkf position on Rwy 22 be alert for possible radio interference or null on frequency 118.7. Use upper antenna if so equipped. Rwy 04 runway visual range touchdown, midfield, rollout avbl. Rwy 22 runway visual range touchdown, midfield, rollout avbl. Rwy 12R runway visual range touchdown avbl. Rwy 30L runway visual range touchdown avbl. Twy G centerline to parked acft on W side only 68'. Twy G centerline to edge of adjacent svc vehicle road on W side only 48'. Due to complex rwy configuration, when taxiing to thlds 12L and 12R and 17 check compass heading before departing. Acft southbound on Twy C to Rwy 30L thld use extreme care, Twy C makes a 45° dogleg to the left crossing Twy K. PAPI Rwy 30L unusable byd 8° left and right of course. Flight Notification Service (ADCUS) available.

NOTE: See Special Notices—U.S. Special Customs Requirement.  
 WEATHER DATA SOURCES: ASOS (713) 847-1462 TDWR.  
 COMMUNICATIONS: D-ATIS 124.6 (713) 847-1491 UNICOM 122.95  
 HOBBY RCO 122.35 (MONTGOMERY COUNTY RADIO)  
 (R) HOUSTON APP CON 134.45 (South) 124.35 (West) 120.05 (East)  
 HOBBY TOWER 118.7  
 HOUSTON GND CON 121.9 CLNC DEL 125.45 PRE-TAXI CLNC 125.45  
 (R) HOUSTON DEP CON 134.45 (South) 123.8 (West) 119.7 (North)  
 AIRSPACE: CLASS B See VFR Terminal Area Chart  
 VOR TEST FACILITY (VOT) 108.4  
 RADIO AIDS TO NAVIGATION: NOTAM FILE HOU.

HOBBY (H) VORW/DME 117.1 HUB Chan 118 N29°39.34' W95°16.60' at fld. 47/5E.  
 ILS/DME 109.9 I-HUB Chan 36 Rwy 04. Class IIIE. DME also serves Rwy 22.  
 ILS/DME 111.3 I-PRQ Chan 50 Rwy 12R. Class IE. DME also serves Rwy 30L.  
 LOC/DME 109.9 I-OIB Chan 36 Rwy 22L. DME also serves Rwy 04. DME unusable byd 17° right of course.  
 ILS/DME 111.3 I-UPU Chan 50 Rwy 30L. Class IE. DME also serves Rwy 12R.

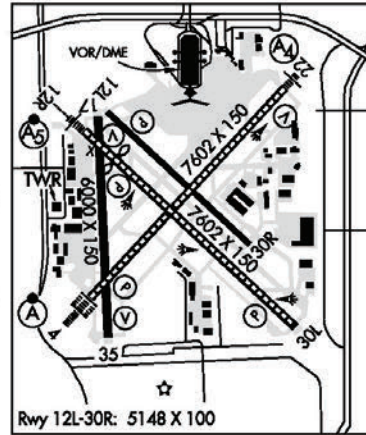

**HOUSTON** MCJ N29°42.83' W95°23.80' HOUSTON  
 AWOS-3 119.575 H-7C, L-19E, 21A, GOMW

FIGURE 195.—Excerpt from Chart Supplement.

HOUSTON, TEXAS

AL-198 (FAA)

13010

LOC/DME I-HUB <b>109.9</b> Chan <b>36</b>	APP CRS <b>041°</b>	Rwy Idg <b>7602</b> TDZE <b>44</b> Apt Elev <b>46</b>
---	------------------------	---

**ILS or LOC RWY 4**  
HOUSTON/ WILLIAM P. HOBBY (HOU)

<b>▽</b> <b>▲</b>	When ALSF-1 inop, increase visibility Cat E ILS ¼ mile, LOC ½ mile.	ALSF-2 	MISSED APPROACH: Climb to 2000 via HUB R-040 to RAYCI INT/HUB 15 DME and hold.	
ATIS <b>124.6</b>	HOUSTON APP CON <b>120.05 379.1</b> EAST <b>124.35 316.15</b> WEST	HOBBY TOWER <b>118.7 256.9</b>	GND CON <b>121.9</b>	CLNC DEL <b>125.45</b>

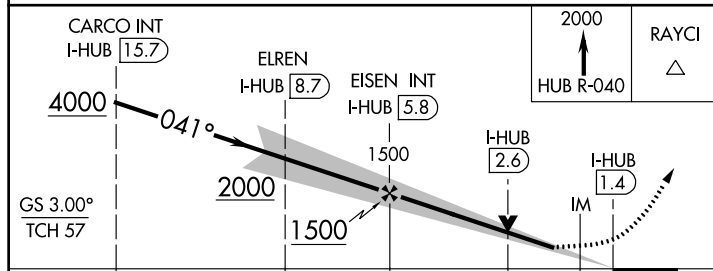
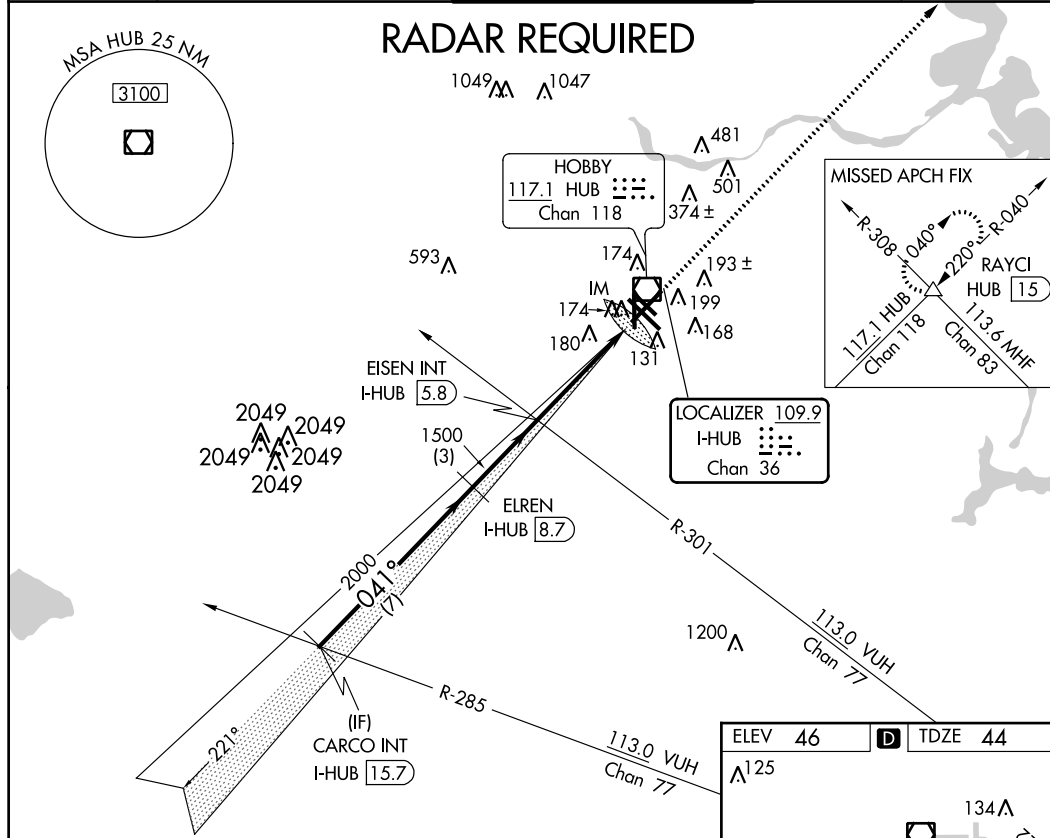

ELEV 46	TDZE 44
125	
134	
121	
120	
119	
118	
117	
116	
115	
114	
113	
112	
111	
110	
109	
108	
107	
106	
105	
104	
103	
102	
101	
100	
99	
98	
97	
96	
95	
94	
93	
92	
91	
90	
89	
88	
87	
86	
85	
84	
83	
82	
81	
80	
79	
78	
77	
76	
75	
74	
73	
72	
71	
70	

REIL Rwy 30L and 35  
MIRL Rwy 12L-30R and 17-35  
HIRL Rwy 4-22 and 12R-30L  
TDZ/CL Rwy 4, 12R and 30L  
FAF to MAP 4.3 NM

Knots	60	90	120	150	180
Min:Sec	4:18	2:52	2:09	1:43	1:26

CATEGORY	A	B	C	D	E	
S-ILS 4	244/18				200 (200-½)	244/24 200 (200-½)
S-LOC 4	480/24	436 (500-½)	480/40 436 (500-¾)	480/50	436 (500-1)	
CIRCLING	500-1	454 (500-1)	520-1½ 474 (500-1½)	600-2	860-3 814 (900-3)	

HOUSTON, TEXAS  
Amdt 40B 05APR12

29°39'N-95°17'W

HOUSTON/ WILLIAM P. HOBBY (HOU)  
**ILS or LOC RWY 4**

FIGURE 196.—ILS or LOC RWY 4 (HOU).

Appendix 2

HOUSTON, TEXAS

AL-5457 (FAA)

WAAS CH <b>45603</b> <b>W35A</b>	APP CRS <b>348°</b>	Rwy Idg <b>6700</b> TDZE <b>152</b> Apt Elev <b>152</b>
--	------------------------	---

# RNAV (GPS) RWY 35L

HOUSTON/DAVID WAYNE HOOKS MEMORIAL (DWH)

**⚠** Baro-VNAV NA when using George Bush Intercontinental/Houston altimeter setting.  
**⚠** For uncompensated Baro-VNAV systems, LNAV/VNAV NA below -15°C (5°F) or above 48°C (119°F). DME/DME RNP-0.3 NA. Visibility reduction by helicopters NA.  
 If local altimeter setting not received, use George Bush Intercontinental/Houston altimeter setting and increase all DAs 36 feet, and all MDAs 40 feet.

MISSED APPROACH: Climb to 2000 direct OILER and hold.

ATIS <b>124.95</b>	HOUSTON APP CON <b>119.7 281.4</b>	HOOKS TOWER★ <b>127.4 354.1 (EAST)</b> <b>118.4 (CTAF) 0 354.1 (WEST)</b>	GND CON <b>121.8 239.0</b>	CLNC DEL <b>119.45</b>	UNICOM <b>122.95</b>
-----------------------	---------------------------------------	---	-------------------------------	---------------------------	-------------------------

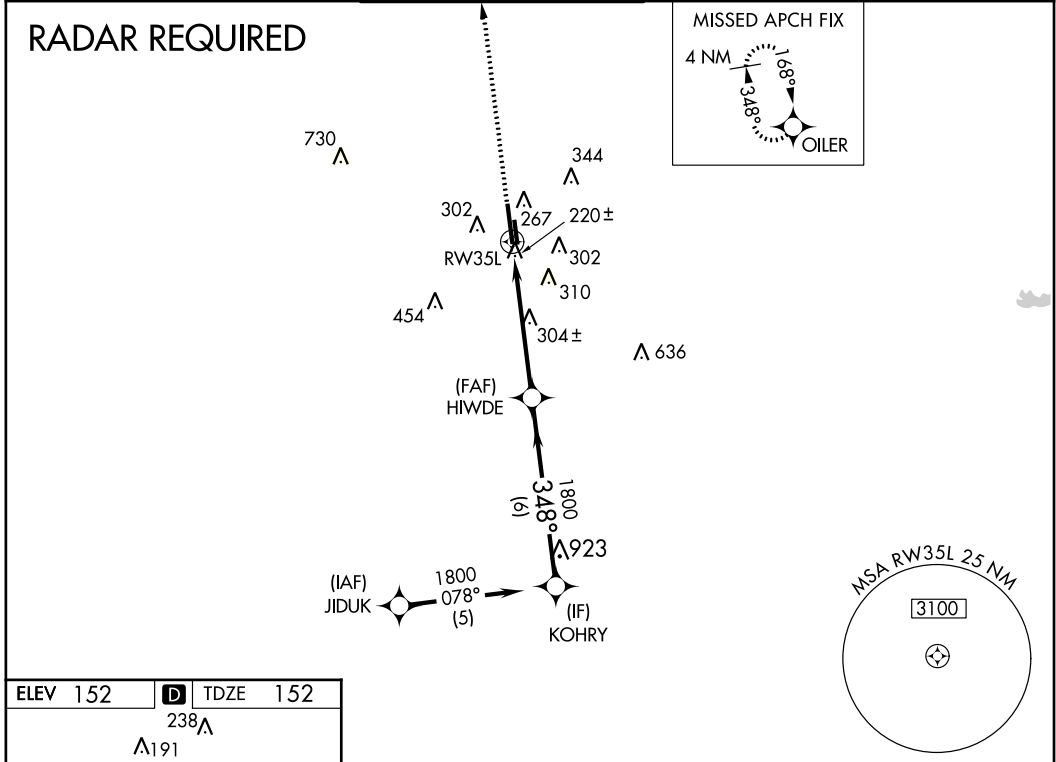

ELEV 152	<b>D</b>	TDZE 152
----------	----------	----------

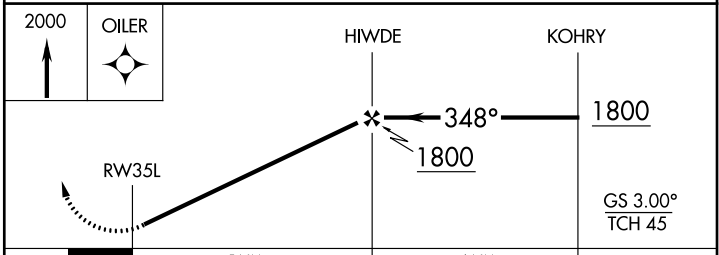
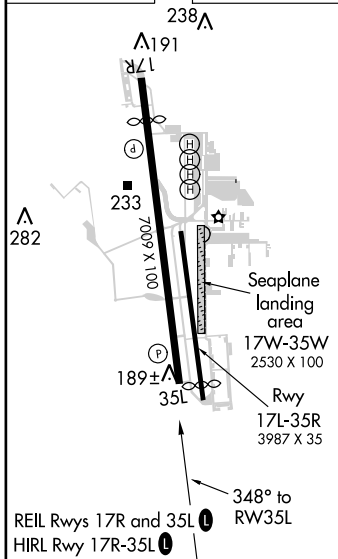

CATEGORY	A	B	C	D
LPV DA		451-1	299 (300-1)	
LNAV/ VNAV DA		552-1½	400 (400-1½)	
LNAV MDA	560-1	408 (500-1)	560-1¼ 408 (500-1¼)	560-1½ 408 (500-1½)
CIRCLING	640-1 488 (500-1)	660-1 508 (600-1)	660-1½ 508 (600-1½)	720-2 568 (600-2)

HOUSTON, TEXAS  
Amdt 1 11237

HOUSTON/DAVID WAYNE HOOKS MEMORIAL (DWH)  
30°04'N-95°33'W

# RNAV (GPS) RWY 35L

FIGURE 197.—RNAV (GPS) RWY 35L(DWH).

**LAFAYETTE RGNL** (LFT) 2 SE UTC-6(-5DT) N30°12.30' W91°59.27'

HOUSTON

42 B S4 FUEL 100LL, JET A OX 1, 4 Class I, ARFF Index B NOTAM FILE LFT

H-7D, L-21B, 22E, GOMC

RWY 04R-22L: H8001X150 (ASPH-GRVD) S-140, D-170, 2S-175,

IAP, AD

2D-290 HIRL

RWY 04R: REIL. PAPI(P4L)—GA 3.0° TCH 53'. Pole. Rgt tfc.

RWY 22L: MALS. PAPI(P4L)—GA 3.0° TCH 52'. Thld dspcd 342'.  
Trees.

RWY 11-29: H5401X148 (ASPH-GRVD) S-85, D-110, 2S-140,

2D-175 MIRL

RWY 11: REIL. PAPI(P4L)—GA 3.0° TCH 35'. Trees. Rgt tfc.

RWY 29: REIL. PAPI(P4L)—GA 3.0° TCH 35'. Tree.

RWY 04L-22R: H4099X75 (ASPH) S-25, D-32 MIRL

RWY 04L: REIL. PAPI(P2L)—GA 3.0° TCH 26'. Tree.

RWY 22R: REIL. PAPI(P2L)—GA 3.0° TCH 27'. Tree. Rgt tfc.

**RUNWAY DECLARED DISTANCE INFORMATION**

RWY 04L:TORA-4099 TODA-4099 ASDA-4099 LDA-4099

RWY 04R:TORA-8001 TODA-8001 ASDA-8001 LDA-8001

RWY 11:TORA-5401 TODA-5401 ASDA-5401 LDA-5401

RWY 22L:TORA-8001 TODA-8001 ASDA-8001 LDA-7659

RWY 22R:TORA-4099 TODA-4099 ASDA-4099 LDA-4099

RWY 29:TORA-5401 TODA-5401 ASDA-5401 LDA-5401

**ARRESTING GEAR/SYSTEM**

RWY 04R: EMAS

RWY 22L: EMAS

**AIRPORT REMARKS:** Attended continuously. Numerous birds on and invof arpt. PPR for unscheduled air carrier ops with more than 30 passenger seats call arpt manager 337-266-4400. Rwy 04L-22R not avbl for air carrier ops with more than 30 passenger seats. Ctc ground control prior to push back from terminal. 155' oil rig 1 NM southeast of arpt. Rwy 22L runway visual range touchdown avbl. Twy B between Twy C and Twy D clsd to acft with wingspan over 80'. Twy F south of Twy B clsd to single wheel acft over 25,000 lbs and dual wheel acft over 32,000 lbs. Twy F reduces to 40' wide. When twr clsd ACTIVATE MALS. Rwy 22L—CTAF, MIRL Rwy 04L-22R not avbl.

**WEATHER DATA SOURCES:** ASOS (337) 237-8153 HIWAS 109.8 LFT.

**COMMUNICATIONS:** CTAF 118.5 ATIS 134.05 UNICOM 122.95

RCO 122.35 (DE RIDDER RADIO)

Ⓡ APP/DEP CON 121.1 (020°-210°) 128.7 (211°-019°) (1130-0430Z‡)

Ⓡ HOUSTON CENTER APP/DEP CON 126.35 (0430-1130Z‡)

TOWER 118.5 (1130-0430Z‡) GND CON 121.8 CLNC DEL 125.55

**AIRSPACE:** CLASS C svc ctc APP CON svc 1130-0430Z‡ other times CLASS E.

**RADIO AIDS TO NAVIGATION:** NOTAM FILE LFT.

(L) VORTACW 109.8 LFT Chan 35 N30°11.63' W91°59.55' at fld. 36/3E. HIWAS.

LAFFS NDB (LOM) 375 LF N30°17.36' W91°54.48' 216° 6.5 NM to fld. Unmonitored when ATCT clsd.

ILS/DME 110.9 I-TYN Chan 46 Rwy 04R. Class IE.

ILS/DME 109.5 I-LFT Chan 32 Rwy 22L. Class IE. LOM LAFFS NDB. ILS and LOM unmonitored when ATCT clsd.

ASR (1130-0430Z‡)

**HELIPAD H1:** H50X50 (ASPH)

HELIPAD H1: RLLS.

**HELIPORT REMARKS:** Rwy H1 circular pad. Helipad H1 perimeter lgts. Heliport ops to/from helipad between Twys B and F and the terminal ramp, avoid overflight of the terminal and other buildings in the 270°-020° quadrant from the helipad. Lead-in lgts two ingress paths. Helicopter parking pads avbl.



**LAFFS** N30°17.36' W91°54.48' NOTAM FILE LFT.

HOUSTON

NDB (LOM) 375 LF 216° 6.5 NM to Lafayette Rgnl. Unmonitored when ATCT clsd.

L-21B, 22E

FIGURE 198.—Excerpt from Chart Supplement.

HOUMA, LOUISIANA

AL-5037 (FAA)

# COPTER VOR/DME RWY 12

HOUMA-TERREBONNE (HUM)

VORTAC TBD <b>112.0</b> Chan 57	APP CRS <b>121°</b>	Rwy Idg <b>4999</b> TDZE <b>9</b> Apt Elev <b>10</b>
---------------------------------------	------------------------	--

**⚠** When local altimeter setting not received, use Louis Armstrong New Orleans Intl altimeter setting and increase MDA 80 feet.

MISSED APPROACH: Climb to 1800 via TBD VORTAC R-122 to BOURG INT/16.3 DME and hold.

ATIS <b>120.25</b>	NEW ORLEANS APP CON <b>118.9 256.9</b>	HOUMA TOWER* <b>125.3 (CTAF) 0346.3</b>	GND CON <b>121.8</b>	UNICOM <b>122.95</b>
-----------------------	---	--	-------------------------	-------------------------

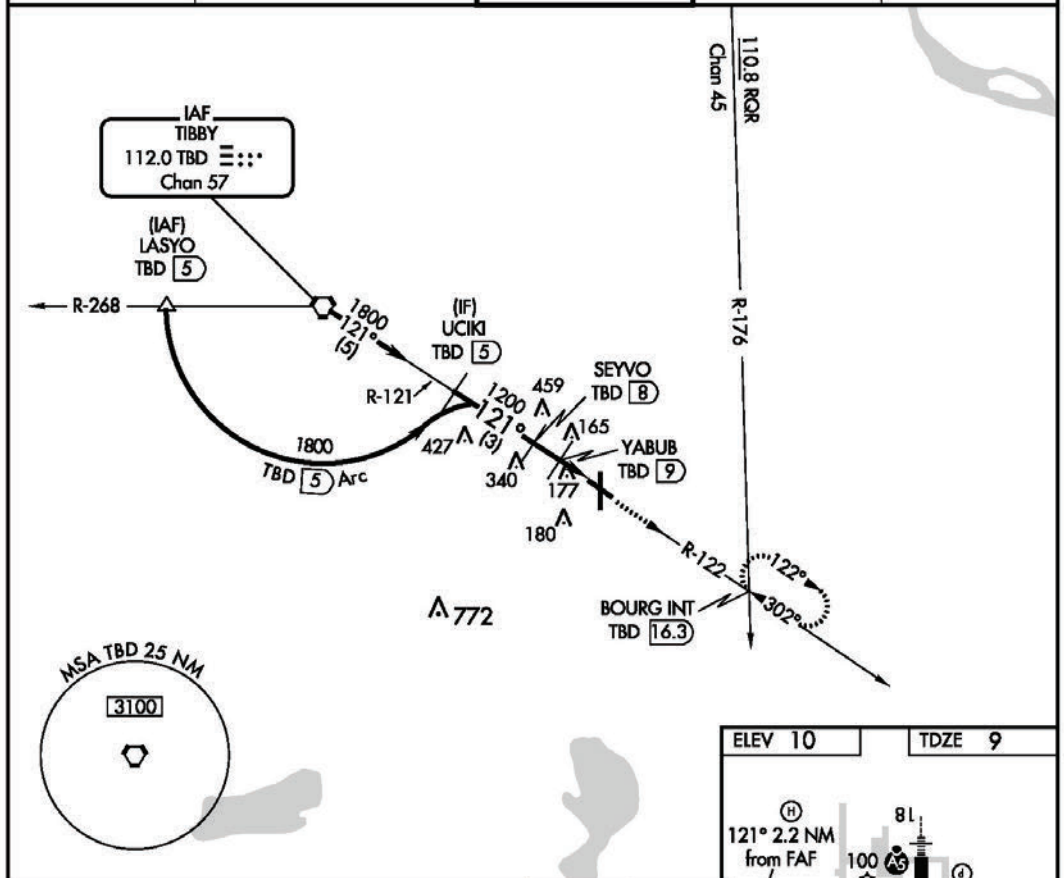

Procedure Turn NA

UCYKI TBD 5

1800

121°

SEYVO TBD 8

YABUB TBD 9

5.03° TCH 45

1200

640

TBD 10.2

3 NM

1 NM

1.2 NM

1800

BOURG INT

TBD R-122

VGSI and descent angles not coincident (VGSI Angle 3.00/TCH 44).

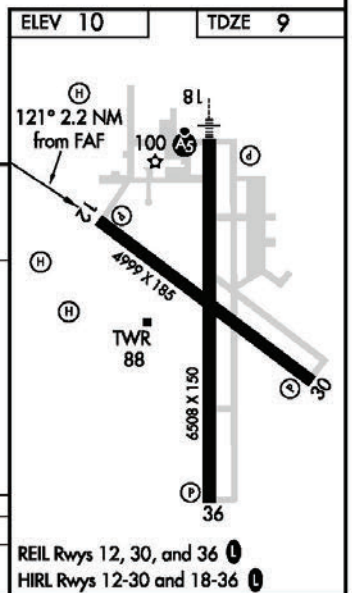

CATEGORY	COPTER	B	C	D
H-12	440-3/4 431 (500-3/4)		NA	

HOUMA, LOUISIANA  
Amdt 4 12264

29°34'N-90°40'W

# COPTER VOR/DME RWY 12

HOUMA-TERREBONNE (HUM)

FIGURE 199.—COPTER VOR/DME RWY 12 (HUM).



HOUMA, LOUISIANA

AL-5037 (FAA)

12292

VORTAC TBD <b>112.0</b> Chan <b>57</b>	APP CRS <b>121°</b>	Rwy Idg <b>4999</b> TDZE <b>9</b> Apt Elev <b>10</b>
--	------------------------	--

**VOR RWY 12**  
HOUMA-TERREBONNE (HUM)

⚠ When local altimeter setting not received, use Louis Armstrong New Orleans Intl altimeter setting and increase all MDA 80 feet, increase S-12 Cat B/C/D and Circling Cat B/C/D visibility ¼ mile. Visibility reduction by helicopters NA.

MISSED APPROACH: Climb to 1800 via TBD R-122 to BOURG INT/TBD 16.3 DME and hold.

ATIS <b>120.25</b>	NEW ORLEANS APP CON <b>118.9 256.9</b>	HOUMA TOWER* <b>125.3(CTAF) 346.3</b>	GND CON <b>121.8</b>	UNICOM <b>122.95</b>
-----------------------	---	--	-------------------------	-------------------------

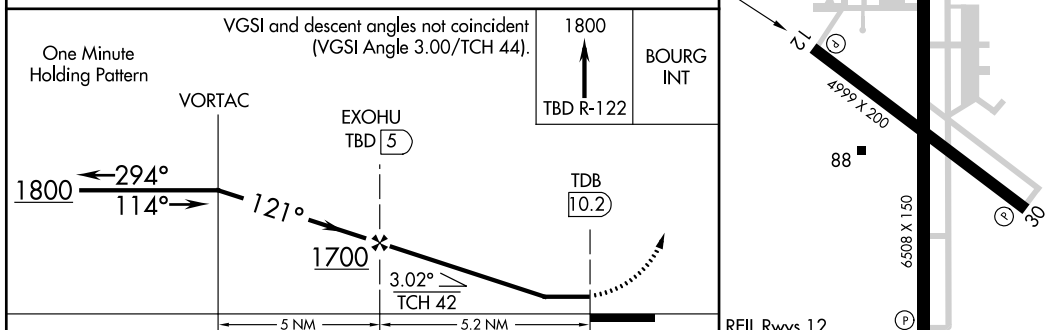
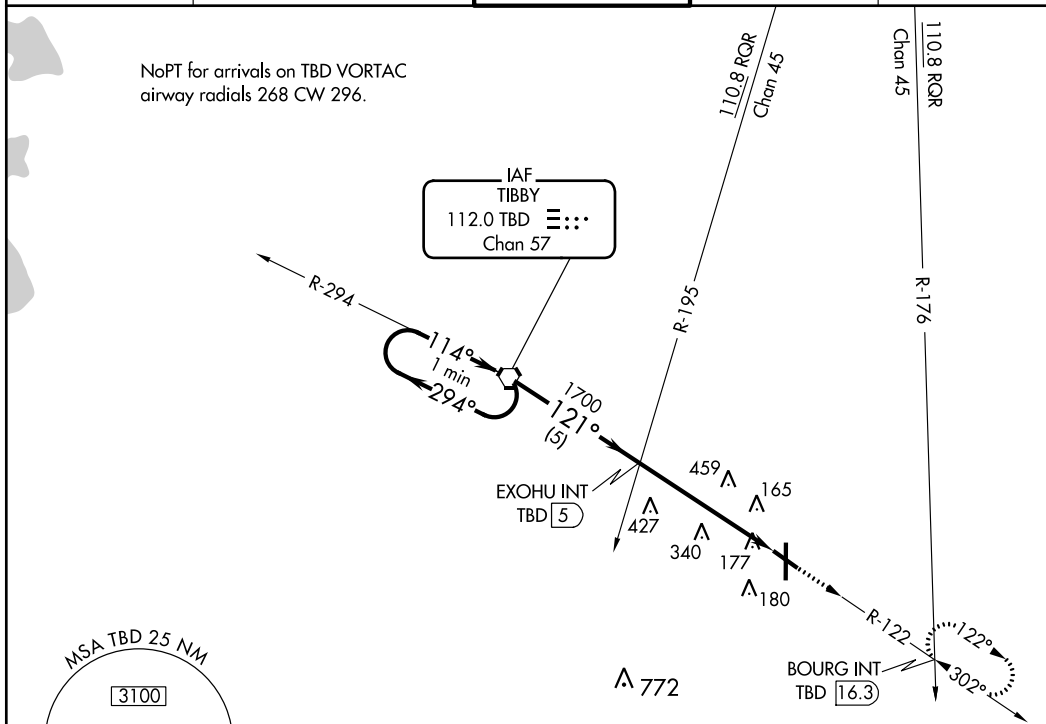

CATEGORY	A	B	C	D
	720-1 711 (800-1)	720-2 711 (800-2)	720-2 711 (800-2)	720-2 711 (800-2)
S-12	720-1 711 (800-1)	720-2 711 (800-2)	720-2 711 (800-2)	720-2 711 (800-2)
CIRCLING	720-1 710 (800-1)	720-2 710 (800-2)	720-2 710 (800-2)	720-2 710 (800-2)

ELEV 10	TDZE 9
---------	--------

REIL Rwy 12, 30, and 36  
HIRL Rwy 12-30 and 18-36  
FAF to MAP 5.2 NM

Knots	60	90	120	150	180
Min:Sec	5:12	3:28	2:36	2:05	1:44

HOUMA, LOUISIANA  
Amdt 5D 18OCT12

29°34'N-90°40'W

HOUMA-TERREBONNE (HUM)  
**VOR RWY 12**

FIGURE 200.—VOR RWY 12 (HUM).

**HOUMA—TERREBONNE (HUM)** 3 SE UTC-6(-5DT) N29°33.99' W90°39.63' NEW ORLEANS  
 9 B S4 FUEL 100LL, JET A OX 1, 2, 3, 4 TPA—1009(1000) NOTAM FILE HUM H-7D, L-21B, 22F  
 RWY 18-36: H6508X150 (CONC-GRVD) S-50, D-70, 2S-89, 2D-137 IAP, AD

HIRL  
 RWY 18: MALSR. PAPI(P2L)—GA 3.0° TCH 52'. Trees.  
 RWY 36: REIL. PAPI(P2L)—GA 3.0° TCH 50'. Trees.  
 RWY 12-30: H4999X185 (CONC) S-50, D-70, 2S-89, 2D-137 HIRL  
 RWY 12: REIL. PAPI(P2L)—GA 3.0° TCH 44'. Trees.  
 RWY 30: REIL. PAPI(P2L)—GA 3.0° TCH 39'.

**AIRPORT REMARKS:** Attended 1200-0100Z $\ddagger$ . Fuel avbl 24 hrs with credit card. Birds on and invof arpt. Numerous birds 500' AGL and blo 2.8 NM south southwest AER 36, avoidance advised. Extensive helicopter ops south thru west of arpt. Rwy 12-30 surface skid resistance fair when wet. ACTIVATE HIRL Rwy 12-30 and Rwy 18-36 and MALSR Rwy 18 and REIL Rwy 12, Rwy 30 and Rwy 36—CTAF.

**WEATHER DATA SOURCES:** AWOS-3PT 120.25 (985) 876-4055. LAWRS.  
**COMMUNICATIONS:** CTAF 125.3 ATIS 120.25 UNICOM 122.95

RCO 122.45 (DE RIDDER RADIO)  
 Ⓡ NEW ORLEANS APP/DEP CON 118.9  
 TOWER 125.3 (1200-0100Z $\ddagger$ ) GND CON 121.8  
**AIRSPACE:** CLASS D svc 1200-0100Z $\ddagger$  other times CLASS G.  
**RADIO AIDS TO NAVIGATION:** NOTAM FILE DRI.

**TIBBY (L) VORTAC** 112.0 TBD Chan 57 N29°39.86' W90°49.75' 122° 10.6 NM to fld. 10/2E.  
 VORTAC unusable:  
 byd 30 NM blo 2,000'  
 TACAN DME unusable:  
 byd 30 NM blo 2,000'  
**HOUMA NDB (LOM)** 219 HU N29°39.80' W90°39.58' 179° 5.8 NM to fld. LOM unmonitored. Unmonitored when ATCT clsd.  
**ILS** 108.5 I-HUM Rwy 18. LOM HOUMA NDB. LOM unmonitored. Unmonitored when ATCT clsd.

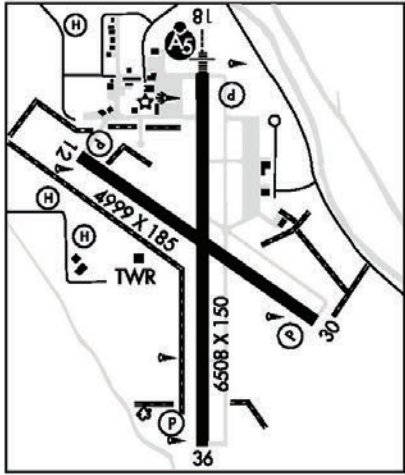

**IDA'S HELIPORT (L87)** 0 N UTC-6(-5DT) N33°00.26' W93°53.59' MEMPHIS  
 286 NOTAM FILE DRI  
**HELIPAD H1:** H40X40 (CONC)  
**HELIPORT REMARKS:** Attended continuously. Helipad H1 perimeter lgts. Helipad H1 100' water twr 300' E and 149' radio twr 500' S of pad. For perimeter lgts call 318-284-3231. Helipad H1 apch 180°-departure 000°.  
**COMMUNICATIONS:** CTAF 122.9

**INDEPENDENCE** IPN N28°05.10' W87°59.15'  
 AWOS-3 118.125 Winds unreliable.

**JEANERETTE**

**LE MAIRE MEM (2R1)** 1 S UTC-6(-5DT) N29°53.94' W91°39.96' HOUSTON  
 14 B FUEL 100LL NOTAM FILE DRI L-21B, 22F  
 RWY 04-22: H3000X75 (ASPH) S-6 MIRL  
 RWY 04: REIL. PAPI(P2L)—GA 3.0° TCH 50'. Trees.  
 RWY 22: REIL. PAPI(P2L)—GA 3.0° TCH 50'. Thld dspcd 603'. Tree.  
**AIRPORT REMARKS:** Unattended. For arpt attended call 337-365-7202. Fuel avbl 24 hrs self svc with credit card. MIRL Rwy 04-22 and REIL Rwy 04 and 22 preset low ints dusk to dawn, to incr ints ACTIVATE—CTAF.  
**COMMUNICATIONS:** CTAF 122.9  
**RADIO AIDS TO NAVIGATION:** NOTAM FILE LFT.  
**LAFAYETTE (L) VORTACW** 109.8 LFT Chan 35 N30°11.63' W91°59.55' 133° 24.5 NM to fld. 36/3E. HIWAS.

FIGURE 201.—Excerpt from Chart Supplement.

10266

# AIRPORT DIAGRAM

AL-5040 (FAA)

NEW IBERIA/ACADIANA RGNL (A.R.A.)  
NEW IBERIA, LOUISIANA

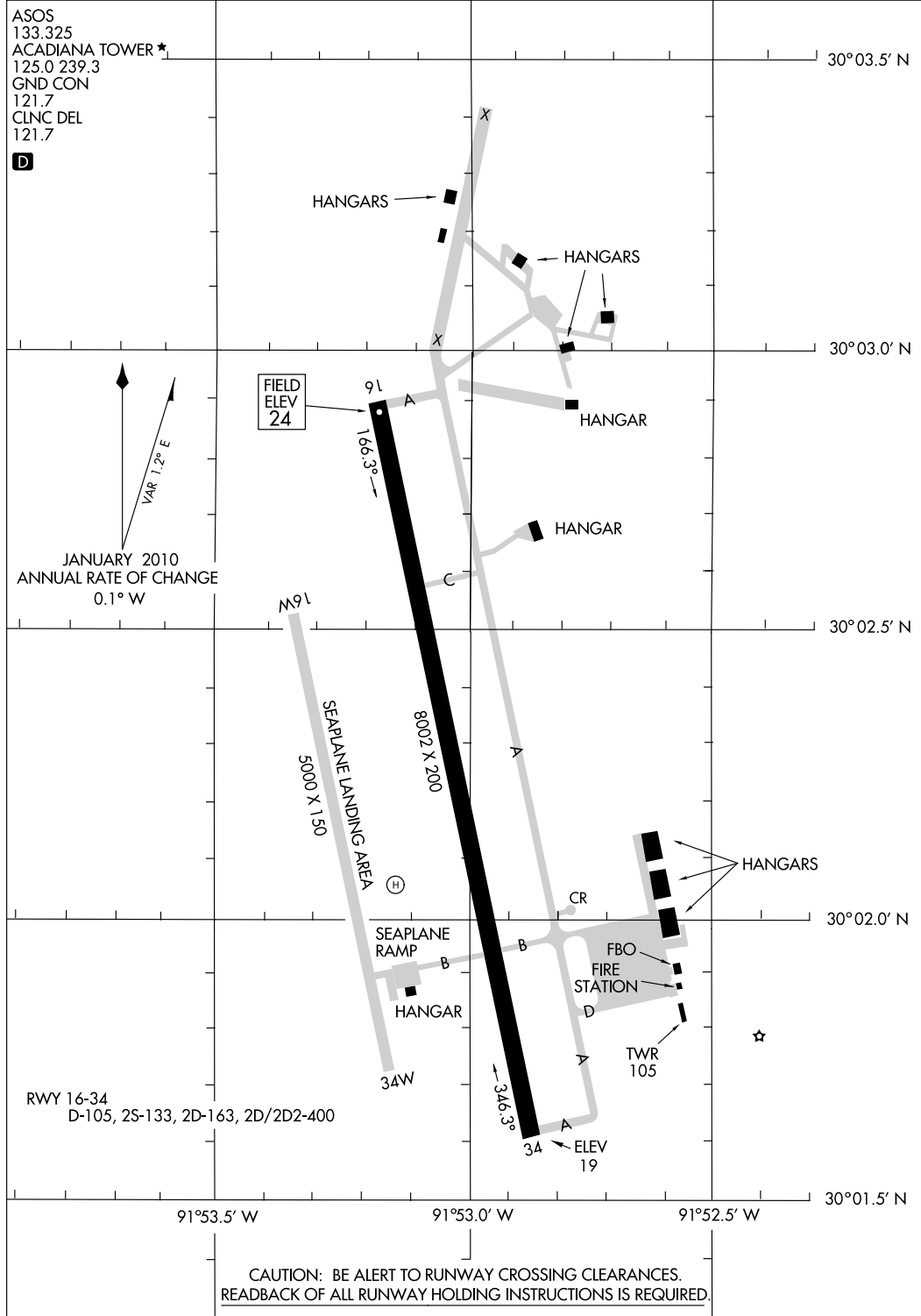

# AIRPORT DIAGRAM

10266

NEW IBERIA, LOUISIANA  
NEW IBERIA/ACADIANA RGNL (A.R.A.)

FIGURE 202.—Airport Diagram: New Iberia/Acadiana RGNL (ARA).

**NATCHITOCHEES RGNL** (IER) 2 S UTC-6(-5DT) N31°44.14' W93°05.95'

HOUSTON  
H-6I, L-22E  
IAP

121 B S4 FUEL 100LL, JET A1+ NOTAM FILE IER

RWY 17-35: H5003X150 (ASPH) S-30 MIRL

RWY 17: REIL. PAPI(P4L)—GA 3.0° TCH 45'. Tree.

RWY 35: ODALS. PAPI(P4L)—GA 3.0° TCH 43'. Trees.

RWY 07-25: H4000X100 (ASPH) S-21 MIRL

RWY 07: Trees.

RWY 25: P-line.

**AIRPORT REMARKS:** Attended dawn-dusk. For arpt attendant after hrs call 318-471-2106. Fuel avbl 24 hr with credit card. MIRL Rwy 17-35 and REIL Rwy 17 preset low ints dusk to dawn, to increase ints and ACTIVATE MIRL Rwy 07-25—CTAF. Rwy 35 ODALS operate low ints continuously, to increase ints ACTIVATE—CTAF.

**WEATHER DATA SOURCES:** AWOS-3 119.025 (318) 352-1575.

**COMMUNICATIONS:** CTAF/UNICOM 122.8

® POLK APP/DEP CON 125.4

GCO 135.075 (FORT POLK APCH AND DE RIDDER FSS)

**RADIO AIDS TO NAVIGATION:** NOTAM FILE AEX.

ALEXANDRIA (H) VORTACW 116.1 AEX Chan 108 N31°15.40'

W92°30.06' 310° 42.0 NM to fld. 80/3E. HIWAS.

VOR unusable:

035°-065° blo 2,000'

066°-094° byd 35 NM blo 3,000'

185°-200° byd 35 NM blo 3,000'

201°-214° byd 35 NM blo 2,000'

215°-260° blo 2,000'

261°-285° byd 35 NM blo 2,000'

357°-034° byd 35 NM blo 3,000'

NDB (MHW) 407 OOC N31°39.45' W93°04.66' 343° 4.8 NM to fld. NOTAM FILE IER.

LOC 110.5 I-IER Rwy 35. LOC unmonitored 0000-1200Z‡.



**NEW IBERIA**

**ACADIANA RGNL** (ARA) 4 NW UTC-6(-5DT) N30°02.27' W91°53.03'

HOUSTON  
H-7D, L-21B, 22E, GOMC  
IAP, AD

24 B S2 FUEL 100LL, JET A OX 4 TPA-1024(1000) Class IV, ARFF Index A

NOTAM FILE ARA

RWY 16-34: H8002X200 (CONC) D-105, 2S-133, 2D-163, 2D/2D2-400 HIRL

RWY 16: ODALS. PAPI(P4L)—GA 3.0° TCH 51'.

RWY 34: MALSR. PAPI(P4L)—GA 3.0° TCH 52'. Rgt tfc.

**RUNWAY DECLARED DISTANCE INFORMATION**

RWY 16: TORA-8002 TODA-8002 ASDA-8002 LDA-8002

RWY 34: TORA-8002 TODA-8002 ASDA-8002 LDA-8002

**AIRPORT REMARKS:** Attended 1300-0300Z‡. For fuel after hrs call 337-367-1401, FAX 337-367-1404. Seaplane landing area (water channel) West of and adjacent/parallel to runway. Rwy 16W-34W seaway edge lgts green; thld lgts amber. Bird activity on and in/ov arpt. ARFF PPR for more than 30 passenger seats call arpt manager 337-365-7202. Rotor wing movement and landing area between the rwy and seaway. Intensive helicopter training. When twr closed HIRL Rwy 16-34 preset low ints, to increase ints and ACTIVATE MALSR Rwy 34—CTAF.

**WEATHER DATA SOURCES:** ASOS 133.325 (337) 365-0128.

**COMMUNICATIONS:** CTAF 125.0 UNICOM 122.95

® LAFAYETTE APP/DEP CON 121.1 (1130-0430Z‡)

HOUSTON CENTER APP/DEP CON 126.35 (0430-1130Z‡)

TOWER 125.0 (1200-0300Z‡) GND CON 121.7 CLNC DEL 121.7

LAFAYETTE CLNC DEL 118.05

AIRSPACE: CLASS D svc 1200-0300Z‡ other times CLASS G.

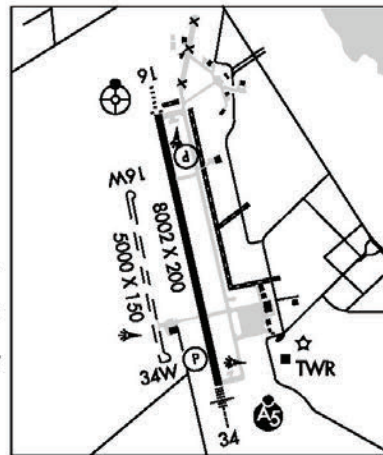

CONTINUED ON NEXT PAGE

FIGURE 203.—Excerpt from Chart Supplement.

LOUISIANA

91

CONTINUED FROM PRECEDING PAGE

RADIO AIDS TO NAVIGATION: NOTAM FILE LFT.

LAFAYETTE (L) VORTACW 109.8 LFT Chan 35 N30°11.63' W91°59.55' 146° 10.9 NM to fld. 36/3E. HIWAS.  
 ACADI NDB (MHW/LOM) 269 AR N29°57.38' W91°51.80' 345° 5.0 NM to fld. NOTAM FILE ARA.  
 ILS 108.9 I-ARA Rwy 34. Class IA. LOM ACADI NDB.

WATERWAY 16W-34W: 5000X150 (WATER) MIRL

WATERWAY 16W: Rgt tfc.

RUNWAY DECLARED DISTANCE INFORMATION

RWY 16W: TORA-5000 TODA-5000 ASDA-5000 LDA-5000  
 RWY 34W: TORA-5000 TODA-5000 ASDA-5000 LDA-5000

SEAPLANE REMARKS: Waterway 16-34 seaway edge lgts green, thld lgts amber. ACTIVATE seaway edge lgts Waterway 16-34-122.7. 3 clicks on 7 clicks off.

NEW ORLEANS

LAKEFRONT (NEW) 4 NE UTC-6(-5DT) N30°02.55' W90°01.70'

7 B S4 FUEL 100LL, JET A OX 1, 3 LRA NOTAM FILE NEW

RWY 18R-36L: H6879X150 (ASPH-GRVD) S-60, D-175, 2S-175,

2D-200, 2D/2D2-350 MIRL

RWY 18R: MALSF. PAPI(P4L)—GA 3.0° TCH 51'. Thld dspld 239'.

Pier. Rgt tfc.

RWY 36L: REIL. PAPI(P4L)—GA 3.0° TCH 50'. Thld dspld 820'. Wall.

RWY 18L-36R: H3697X75 (ASPH) S-35, D-55, 2D-80 MIRL

RWY 18L: REIL.

RWY 36R: REIL. PAPI(P4L)—GA 3.0° TCH 45'. Bldg. Rgt tfc.

RWY 09-27: H3114X75 (ASPH) S-50, D-80, 2S-102, 2D-100 MIRL

RWY 09: REIL. PAPI(P4L)—GA 3.0° TCH 40'. Berm.

RWY 27: PAPI(P4R)—GA 3.0° TCH 40'. Road. Rgt tfc.

RUNWAY DECLARED DISTANCE INFORMATION

RWY 09: TORA-3113 TODA-3113 ASDA-3113 LDA-3113  
 RWY 18L: TORA-3697 TODA-3697 ASDA-3697 LDA-3697  
 RWY 18R: TORA-6880 TODA-6880 ASDA-6035 LDA-5510  
 RWY 27: TORA-3113 TODA-3113 ASDA-3113 LDA-3113  
 RWY 36L: TORA-6880 TODA-6880 ASDA-5955 LDA-5135  
 RWY 36R: TORA-3697 TODA-3697 ASDA-3697 LDA-3697

AIRPORT REMARKS: Attended continuously. For field conditions after 2200Z‡

ctc arpt manager on 504-914-5721. Birds on and invof arpt. Boats as high as 80' pass within 400' of Rwy 09 thld. Rwy 18R-36L few low spots near intersection of Rwy 09-27 holding water. When twr clsd MIRL Rwy 18R-36L preset med ints and twy lgts for Twys A, B, D, E, F and H preset on medium. ARFF capability equivalent to Index B. Acft transporting any items listed in Part 175 title 49 PPR to land. Landing fee. Landing fee waived with minimum fuel purchase. Flight Notification Service (ADCUS) temporarily not available. NOTE: See Special Notices—U.S. Special Customs Requirement.

WEATHER DATA SOURCES: ASOS (504) 245-4366 LAWRS.

COMMUNICATIONS: CTAF 119.9 ATIS 124.9

NEW ORLEANS RCO 122.6 (DE RIDDER RADIO)

Ⓡ NEW ORLEANS APP/DEP CON 133.15 (North) 123.85 (South)

TOWER 119.9 (1400-0000Z‡) GND CON 121.7 CLNC DEL 127.4 (NEW ORLEANS APP/DEP CON when twr clsd)

AIRSPACE: CLASS D svc 1400-0000Z‡ other times CLASS E.

RADIO AIDS TO NAVIGATION: NOTAM FILE NEW.

HARVEY (H) VORTACW 114.1 HRV Chan 88 N29°51.01' W90°00.18' 351° 11.6 NM to fld. 2/2E.

VORTAC unusable:

- 004°-125° byd 30 NM blo 2,000'
- 126°-136° byd 25 NM blo 3,000'
- 137°-174° byd 30 NM blo 2,000'
- 175°-190° byd 30 NM blo 3,000'
- 191°-239° byd 30 NM blo 2,000'
- 240°-255° byd 25 NM blo 6,000'
- 256°-279° byd 30 NM blo 2,000'
- 280°-290° byd 30 NM
- 291°-352° byd 30 NM blo 2,000'
- 353°-003° byd 30 NM blo 3,000'

ILS/DME 111.3 I-NEW Chan 50 Rwy 18R.

NEW ORLEANS

H-7E, 8F, L-21B, 22F, GOMC

IAP, AD

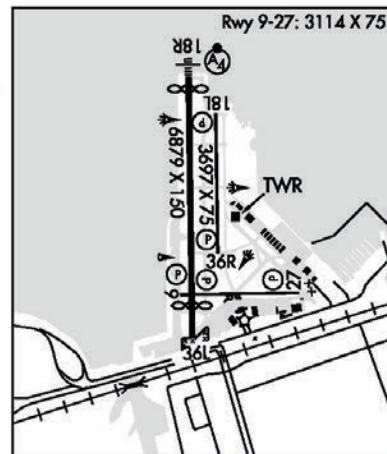

FIGURE 203A.—Excerpt from Chart Supplement.

Appendix 2

13066

AIRPORT DIAGRAM

AL-288 (FAA)

NEW ORLEANS/LAKEFRONT (NEW)  
NEW ORLEANS, LOUISIANA

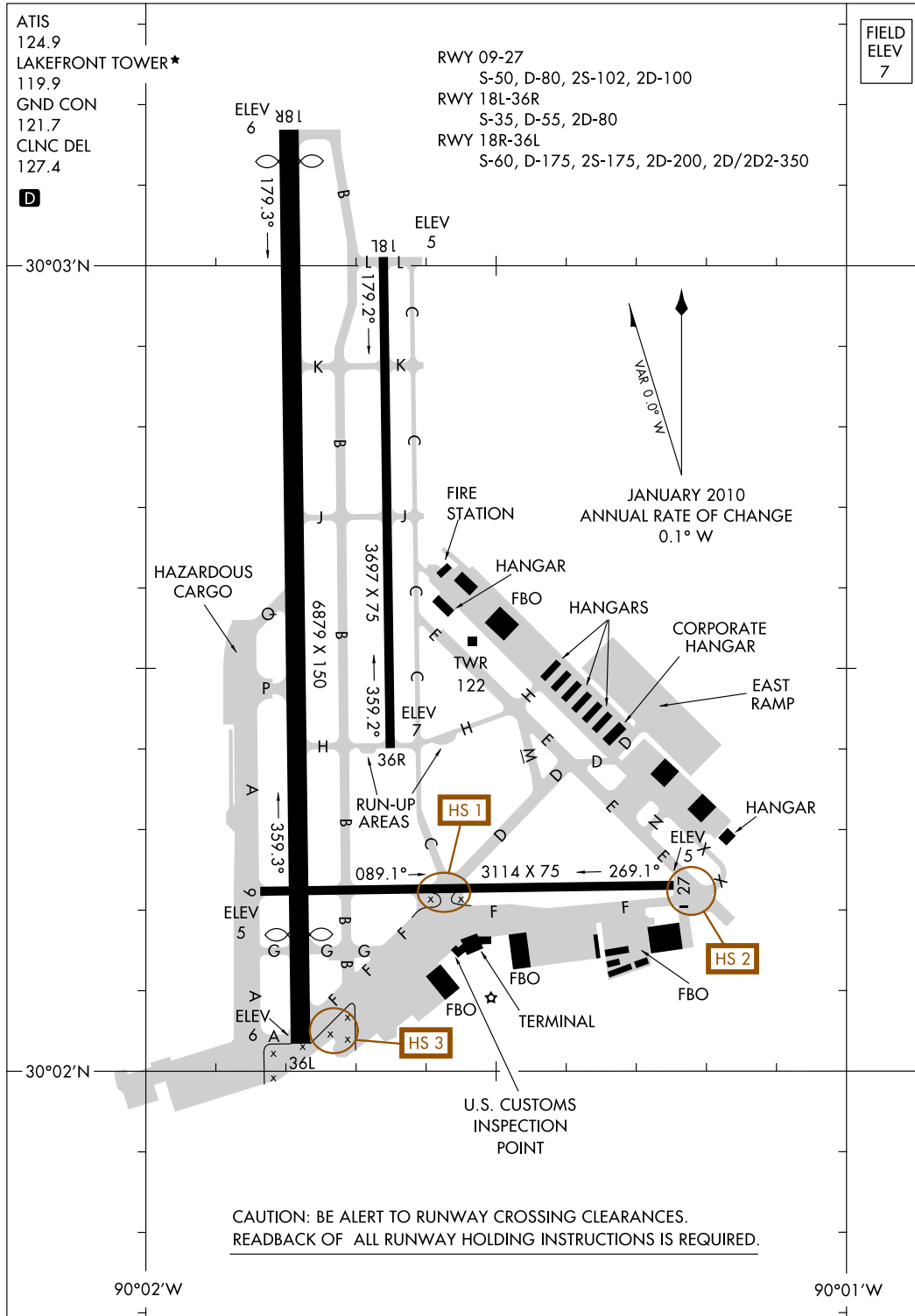

AIRPORT DIAGRAM

13066

NEW ORLEANS, LOUISIANA  
NEW ORLEANS/LAKEFRONT (NEW)

FIGURE 204.—Airport Diagram: New ORLEANS/LAKEFRONT (NEW).

12264

AIRPORT DIAGRAM

AL-754 (FAA)

HONOLULU INTL (HNL) (PHNL)  
HONOLULU, HAWAII

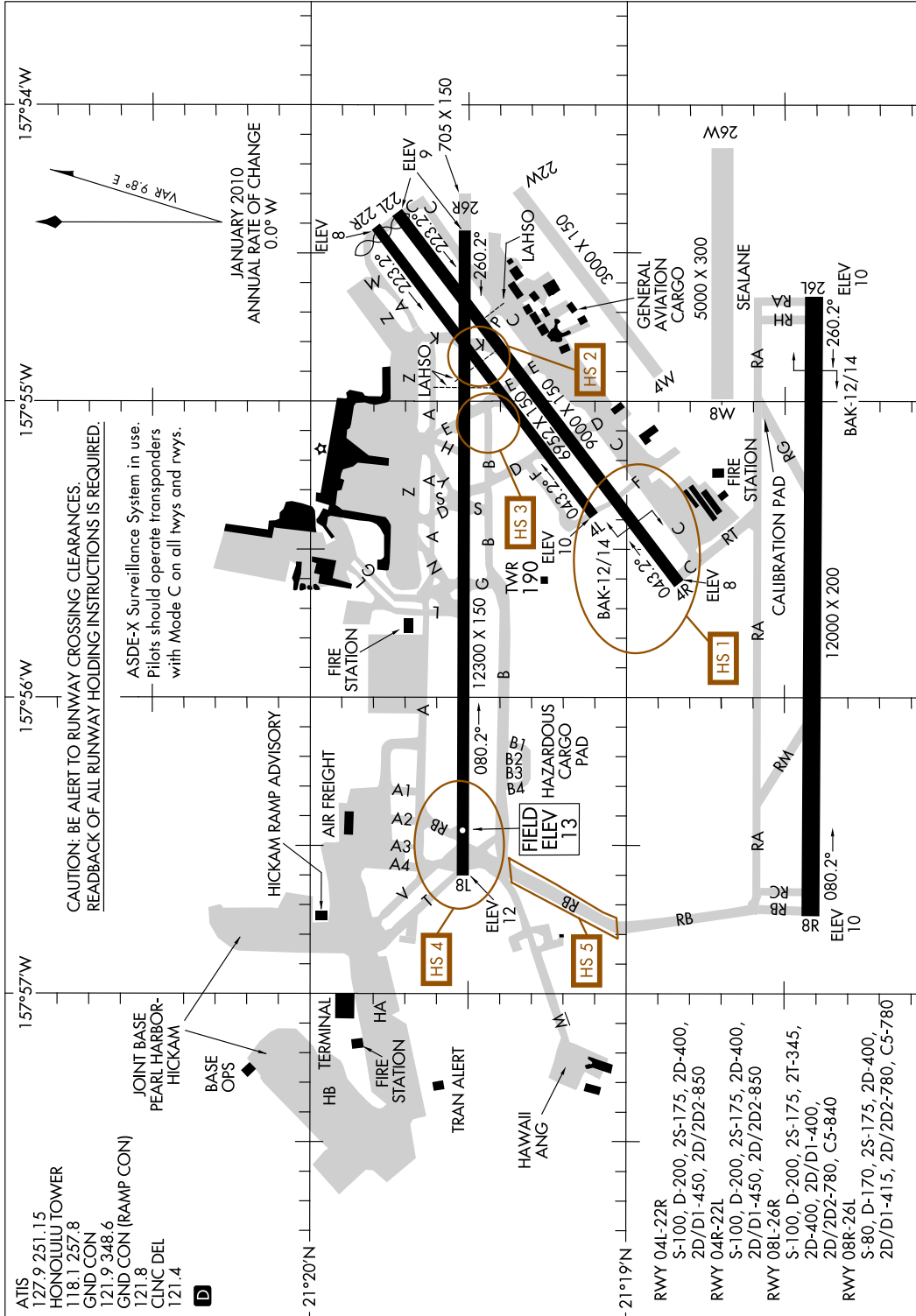

AIRPORT DIAGRAM

12264

HONOLULU, HAWAII  
HONOLULU INTL (HNL) (PHNL)

FIGURE 205.—Airport Diagram: Honolulu Intl (HNL) (PHNL).

**AIRPORT/FACILITY DIRECTORY**

**HONOLULU INTL (JOINT BASE PEARL HARBOR-HICKAM)** (HNL)(PHNL) 3 NW UTC-10 **HAWAIIAN-MARIANA**

N21°19.12' W157°55.35'  
 13 B S4 **FUEL** 80, 100, JET A, A1+, B OX 1, 2, 3, 4 TPA—See Remarks **P-1C, 2G**  
 LRA Class I, ARFF Index E NOTAM FILE HNL **IAP**

**RWY 08L-26R:** H12300X150 (ASPH-GRVD) S-100, D-200, 2S-175, 2T-345, 2D-400, 2D/D1-400, D2D/2D2-780 HIRL

**RWY 08L:** MALSR. PAPI(P4L)—GA 3.0° TCH 80'.

**RWY 26R:** REIL. PAPI(P4L)—GA 3.0 TCH 71'.

**RWY 08R-26L:** H12000X200 (ASPH-GRVD) S-80, D-170, 2S-175, 2D-400, D/2D2-780 HIRL

**RWY 08R:** REIL. PAPI(P4L)—GA 3.25° TCH 99'.

**RWY 26L:** MALSF. PAPI(P4L)—GA 3.0° TCH 75'. 3 cranes.

**RWY 04R-22L:** H9000X150 (ASPH-GRVD) S-100, D-200, 2S-175, 2D-400, D/2D2-850 HIRL

**RWY 04R:** MALSR. PAPI(P4L)—GA 3.0° TCH 71'. Tree.

**RWY 22L:** REIL. PAPI(P4L)—GA 3.44° TCH 80'. Stack.

**RWY 04L-22R:** H6952X150 (ASPH) S-100, D-200, 2S-175, 2D-400, D/2D2-850 MIRL

**RWY 04L:** REIL. PAPI(P4L)—GA 3.0° TCH 50'. **RWY 22R:** REIL. Antenna. Thld dsplcd 150'.

**LAND AND HOLD-SHORT OPERATIONS**

LDG RWY	HOLD-SHORT POINT	AVBL LDG DIST
<b>RWY 04L</b>	08L-26R	3700
<b>RWY 04R</b>	08L-26R	6250
<b>RWY 08L</b>	04L-22R	9300

**RUNWAY DECLARED DISTANCE INFORMATION**

**RWY 04R:** TORA-9000 TODA-9000 ASDA-8950 LDA-8950

**RWY 22L:** TORA-9000 TODA-9000 ASDA-8937 LDA-8937

**ARRESTING GEAR/SYSTEMS**

**RWY 04R** BAK-14 BAK-12B (1500')

HOOK MB 60 (200') → **RWY 26R**  
 BAK-14 BAK 12B(B) (1500) **RWY 26L**

**AIRPORT REMARKS:** Attended continuously. 80 and 100 octane fuel avbl thru FBO. Bird strike hazard all runways. Mil acft opr during Bird Watch Condition MODERATE (initial tkof or full stop ldg only, no multiple IFR/VFR approaches) and SEVERE (tkof and ldg prohibited w/o 15 OG/CC approval or 154 OG/CC approval for HIANG acft) ctc HIK ramp, PTD, 15 WG command post, 735 AMC command post, 154 WG command post for current conditions. See FLIP AP/3 Supplementary arpt information, route and area rstd, and Oakland FIR flt haz. Use caution for obstruction 76' from Twy M centerline on Oceanside, approximately 200' from parking apron. Crane 290' AGL approximately 2,600' north of Rwy 08L, 2500' west of Inter Island Terminal 1630-0330Z daily. PAEW 600'-1300'E Rwy 22L and Rwy 22R thld. 1700-0130Z Mon-Fri. Rwy CLOSED 1730-0630 every month as follows: Rwy 04R-22L first Tue; Rwy 08R-26L second Tue; and Rwy 08L-26R third Tue. Rwy 08R-26L 200' pavement width with lgts outside, pavement striped 150' wide. Thld of Rwy 08L difficult to determine due to Twy T. All jet acft ctc ramp control prior to engine start at gate or hard stand. Foreign object debris hazard exits on all movement areas east of Twy S. Fighter acft exercise extreme caution when taxiing. To minimize foreign object damage potential, all acft should use minimum thrust, especially outboard engines, when taxiing past the F-22 alert facility on Twy T. Twys G and L between Twy A and Inter-Island ramp clsd to wide-bodied and 4-engine turbo-jet acft under power without PPR from arpt ops manager 808-836-6428 Mon-Fri 1745-0230Z. Twy K not a high speed exit twy. Wide body and 4 engine turbojets ldg on Rwy 04R roll to end of rwy, no left turn at Twy K without approval. Tfc pattern overhead altitude 2000(1987), restricted to HIANG acft. Rwy 04R-22L and Rwy 08R-26L sfc grvd within 10' of A-G system. Potential for fighter acft tail hook skip exists. Due to sensitivities of citizens, fighter acft and water-augmented acft dep only authorized from Mon-Sat 1700-0700Z, and Sun and holidays 1800-0700Z. All request for waivers will be sent to the 15/OG/CC at least 5 working days in advance. Waivers will be granted on extreme necessary. If short notice mission essential waivers are necessary, ctc 15OG/CC by phone thru 15 WG Comd Post (15 WG/CP). 15 WG Comd Post will pass approval to Hickam flight svc and Hickam ramp advisory. Tfc pattern altitude for small acft entering from NW 800(787). Tfc pattern altitude for small acft entering from S 1000(987). Tfc pattern altitude for large acft entering from S 1500(1487). No F-16 transient support avbl in accordance with Area Control Center LSET flash safety 06-02. Transient F-16 units should provide their own maintenance support. PPR all acft units planning to stage ops from Hickam AFB must ctc 15 OSS/OSX DSN 315-449-1596/1597 at least 60 days prior to arrival. All military acft rqr Customs/Agriculture/Immigration inspection must ctc 15 WG command post or if Air Mobility Command ctc Hickam AMCC, no later than 3 hrs prior to arrival with departure location estimated block time, number of aircrew, Civilian/Military Passengers/Foreign Nationals/and Distinguished Visitor codes. JBPH-H is PPR to all non-AMC acft and AMC trng msn (QEN, KEN, PEN, AEN, and ANC C130's). All tran acft not on an AMC/TWCF msn and home stn acft terminating at JBPH-H, will provide a 3 hr out call (COMM 808-448-6900) as well as a 20-30 min out call on 292.5 to the 15 WG/CP (KOA CONTROL). All transient acft, not on an Air Mobility Command mission, will provide a 2-3 hr out call, as well as 20-30 minute out call on 292.5 to the 15 WG/CP (KOA Control). 15 WG can provide eqpt but crews must provide own pers when needed. Upon arrival, crews will proceed directly to Command Post (Bldg 2050) and complete an outbound setup sheet to facilitate departure requirements. No COMSEC material avbl thru Hickam Airfield Ops. Transient aircrews should plan to arrive with appropriate amount of COSMEC to complete entire mission. Arfld

**CONTINUED ON NEXT PAGE**

FIGURE 206.—Excerpt from Chart Supplement.



This page is intentionally left blank

(STELA.STELA1) 16259

ST-460 (FAA)

WINDSOR LOCKS, CONNECTICUT

STELA ONE ARRIVAL

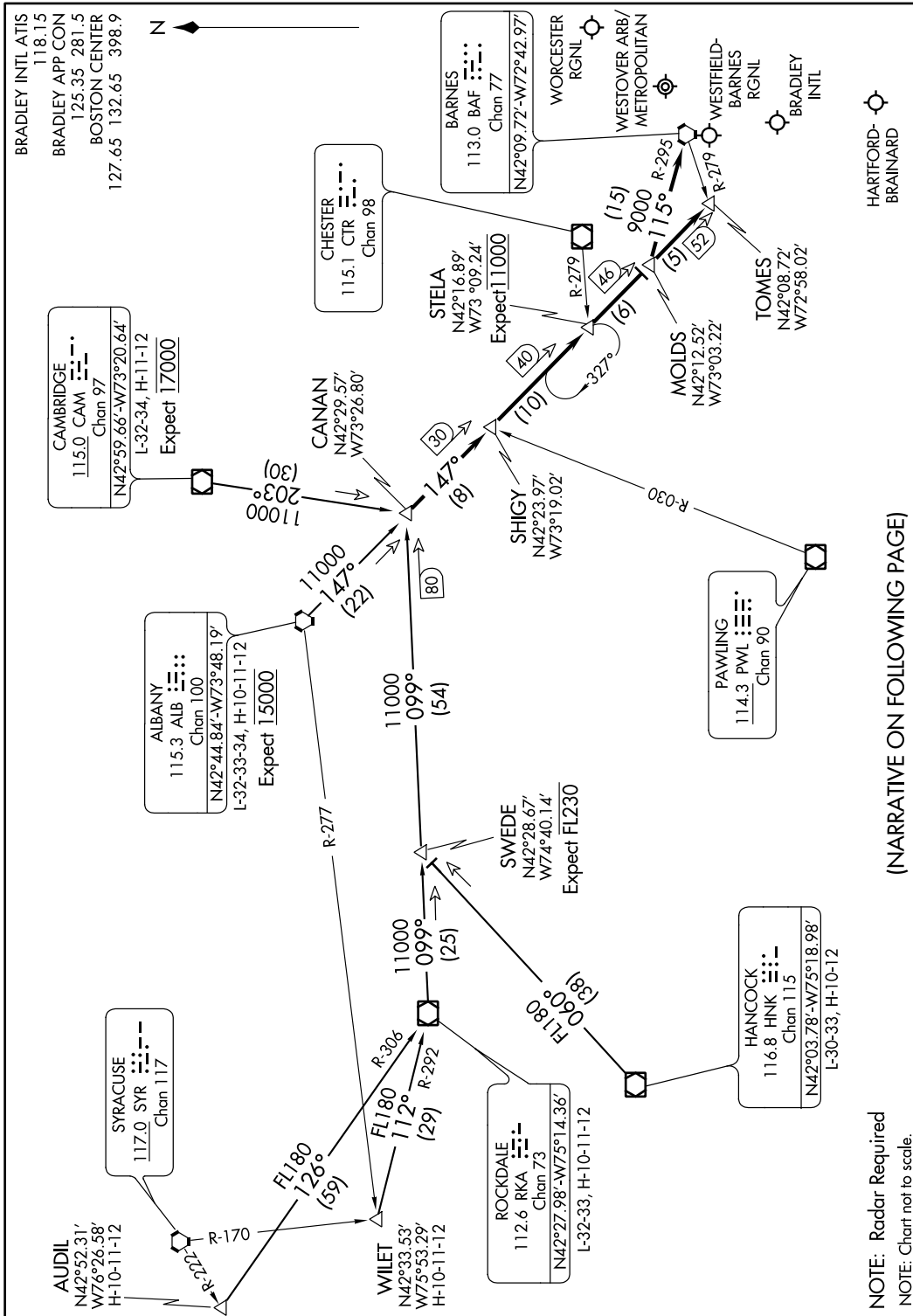

(NARRATIVE ON FOLLOWING PAGE)

NOTE: Radar Required  
NOTE: Chart not to scale.

STELA ONE ARRIVAL  
(STELA.STELA1) 31MAY12

WINDSOR LOCKS, CONNECTICUT

FIGURE 208.—STELA One Arrival (STELA.STELA1).

(STELA.STELA1) 16259

ST-460 (FAA)

**STELA ONE ARRIVAL**

WINDSOR LOCKS, CONNECTICUT

**ARRIVAL ROUTE DESCRIPTION**

ALBANY TRANSITION (ALB.STELA1): From over ALB VORTAC via ALB R-147 to CANAN INT. Thence. . . .

AUDIL TRANSITION (AUDIL.STELA1): From over AUDIL INT via RKA R-306 to RKA VOR/DME, then via RKA R-099 to CANAN INT. Thence. . . .

CAMBRIDGE TRANSITION (CAM.STELA1): From over CAM VOR/DME via CAM R-203 to CANAN INT. Thence. . . .

HANCOCK TRANSITION (HNK.STELA1): From over HNK VOR/DME via HNK R-060 to SWEDE INT, then via RKA R-099 to CANAN INT. Thence. . . .

WILET TRANSITION (WILET.STELA1): From over WILET INT via RKA R-292 to RKA VOR/DME, then via RKA R-099 TO CANAN INT. Thence. . . .

KBDL and KHFD ARRIVALS: From over CANAN INT via ALB R-147 to TOMES INT. Expect radar vectors to final approach course prior to TOMES INT.

KBAF, KCEF and KORH ARRIVALS: From over CANAN INT via ALB R-147 to MOLDS INT. Then via BAF R-295 to BAF VORTAC. Expect radar vectors to final approach course prior to BAF VORTAC.

**STELA ONE ARRIVAL**  
(STELA.STELA1) 31MAY12

WINDSOR LOCKS, CONNECTICUT

FIGURE 209.—STELA One Arrival (STELA.STELA1).

WINDSOR LOCKS, CONNECTICUT

AL-460 (FAA)

16203

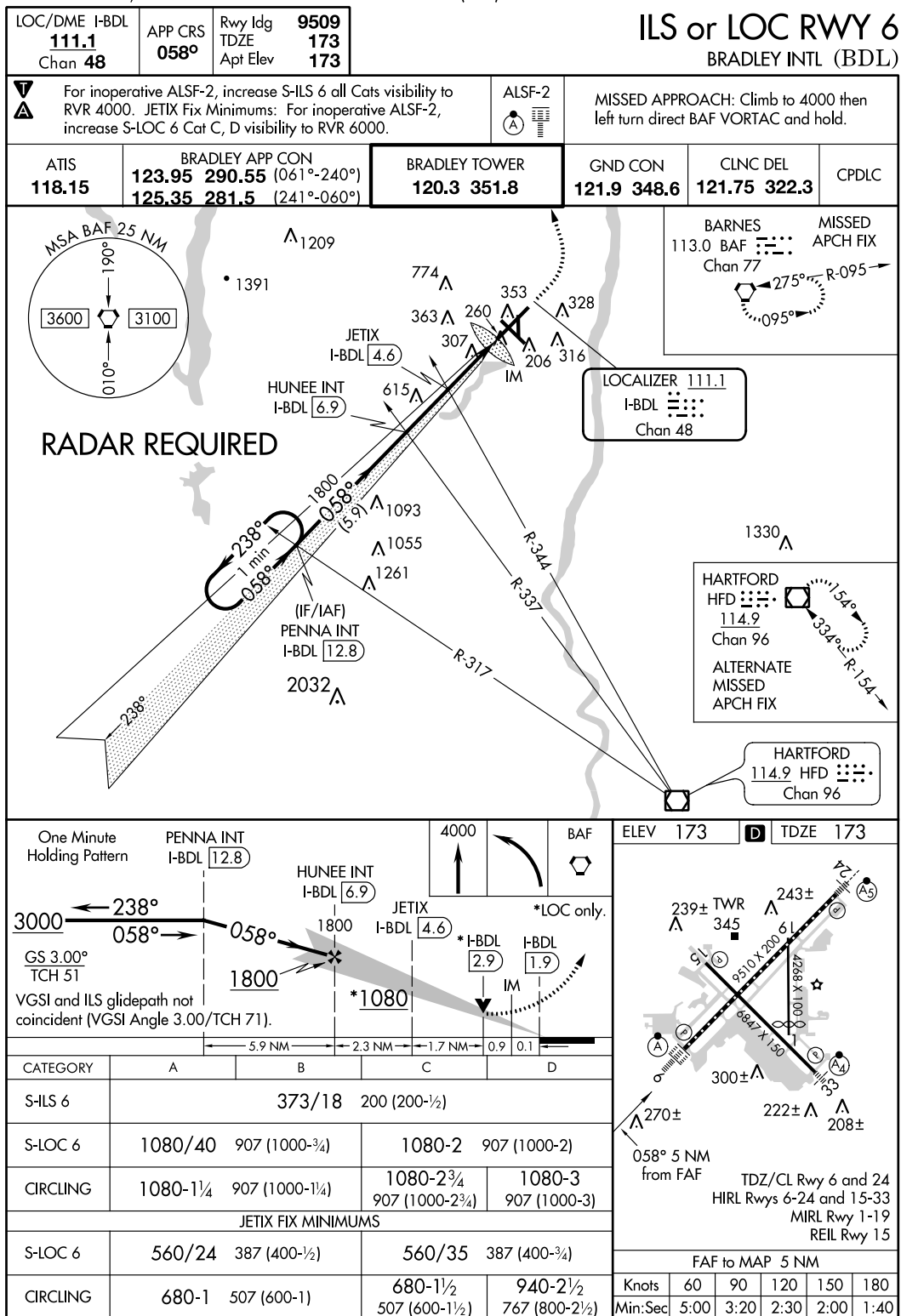
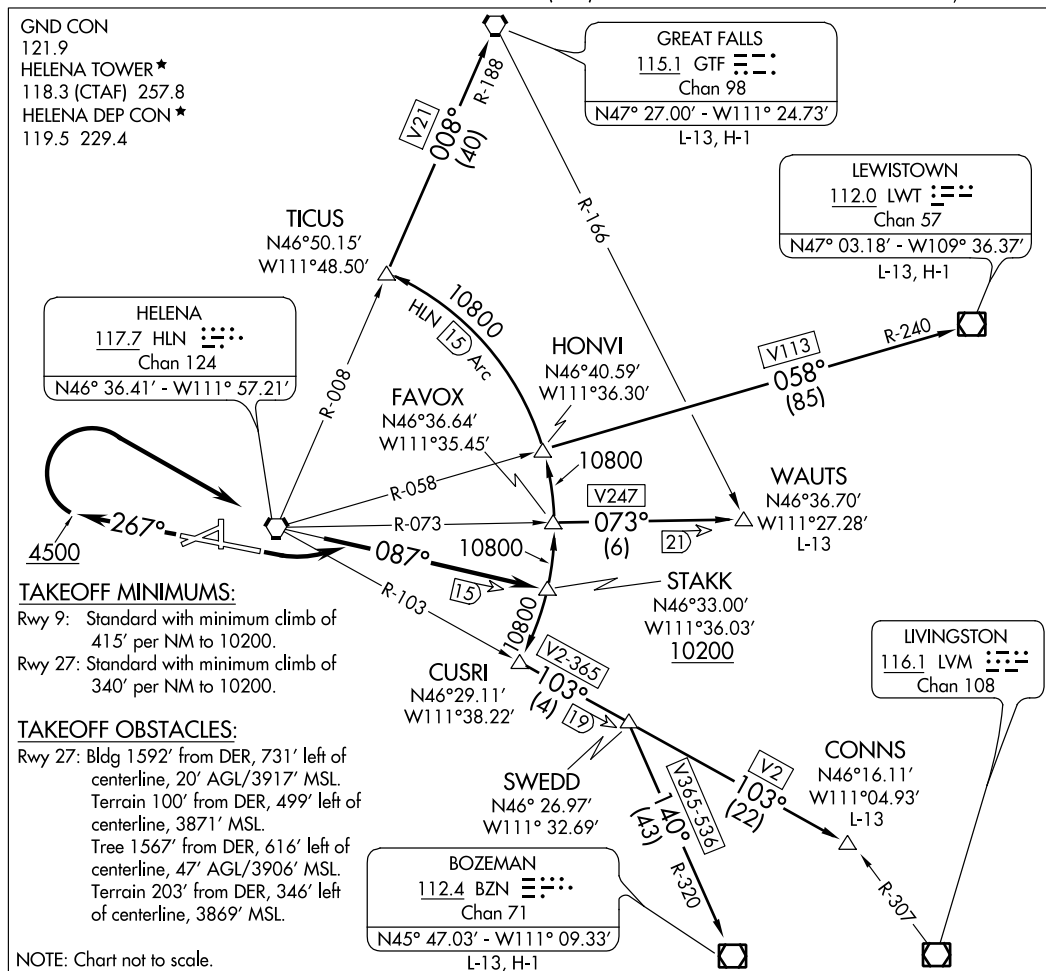

FIGURE 210.—ILS or LOC RWY 6 (CAT I) (BDL).

(STAKK3.STAKK) 12040

STAKK THREE DEPARTURE

HELENA RGNL (HLN)  
HELENA, MONTANA



DEPARTURE ROUTE DESCRIPTION

**TAKEOFF RUNWAY 9:** Climbing left turn to intercept HLN R-087 to cross STAKK at or above 10200. Thence via transition.

**TAKEOFF RUNWAY 27:** Climb heading 267° to 4500 then climbing right turn direct HLN VORTAC. Continue climb on HLN R-087 to cross STAKK at or above 10200. Thence via transition.

**BOZEMAN TRANSITION (STAKK3.BZN):** From over STAKK via 15 DME Arc to CUSRI INT, then via HLN R-103 to SWEDD INT, then via BZN R-320 to BZN VOR/DME.

**CONNS TRANSITION (STAKK3.CONNS):** From over STAKK via 15 DME Arc to CUSRI INT, then via HLN R-103 to SWEDD INT, then via HLN R-103 to CONNS INT.

**GREAT FALLS TRANSITION (STAKK3.GTF):** From over STAKK via 15 DME Arc to FAVOX, then via 15 DME Arc to HONVI, then via 15 DME Arc to TICUS, then via HLN R-008 and GTF R-188 to GTF VORTAC.

**LEWISTOWN TRANSITION (STAKK3.LWT):** From over STAKK via 15 DME Arc to FAVOX, then via 15 DME Arc to HONVI, then via HLN R-058 and LWT R-240 to LWT VOR/DME.

**WAUTS TRANSITION (STAKK3.WAUTS):** From over STAKK via 15 DME Arc to FAVOX, then via HLN R-073 to WAUTS INT.

STAKK THREE DEPARTURE

(STAKK3.STAKK) 12040

HELENA, MONTANA  
HELENA RGNL (HLN)

FIGURE 211.—STAKK Three Departure (STAKK3.STAKK) (HLN).

BILLINGS, MONTANA

AL-48 (FAA)

13290

WAAS CH <b>56222</b> <b>W28A</b>	APP CRS <b>278°</b>	Rwy Idg THRE <b>3488</b> Apt Elev <b>3652</b>
--	------------------------	--

# RNAV (GPS) RWY 28R

BILLINGS LOGAN INTL (BIL)

▼ For uncompensated Baro-VNAV systems, LNAV/VNAV NA below -27°C (-16°F) or above 21°C (69°F).  
DME/DME RNP-0.3 NA. Visibility reduction by helicopters NA.

MISSED APPROACH: Climb to 5900 direct WIBON and hold.

ATIS <b>126.3</b>	BILLINGS APP CON <b>120.5 284.6</b>	BILLINGS TOWER <b>127.2 257.8</b>	GND CON <b>121.9</b>	CLNC DEL <b>121.9</b>
----------------------	--	--------------------------------------	-------------------------	--------------------------

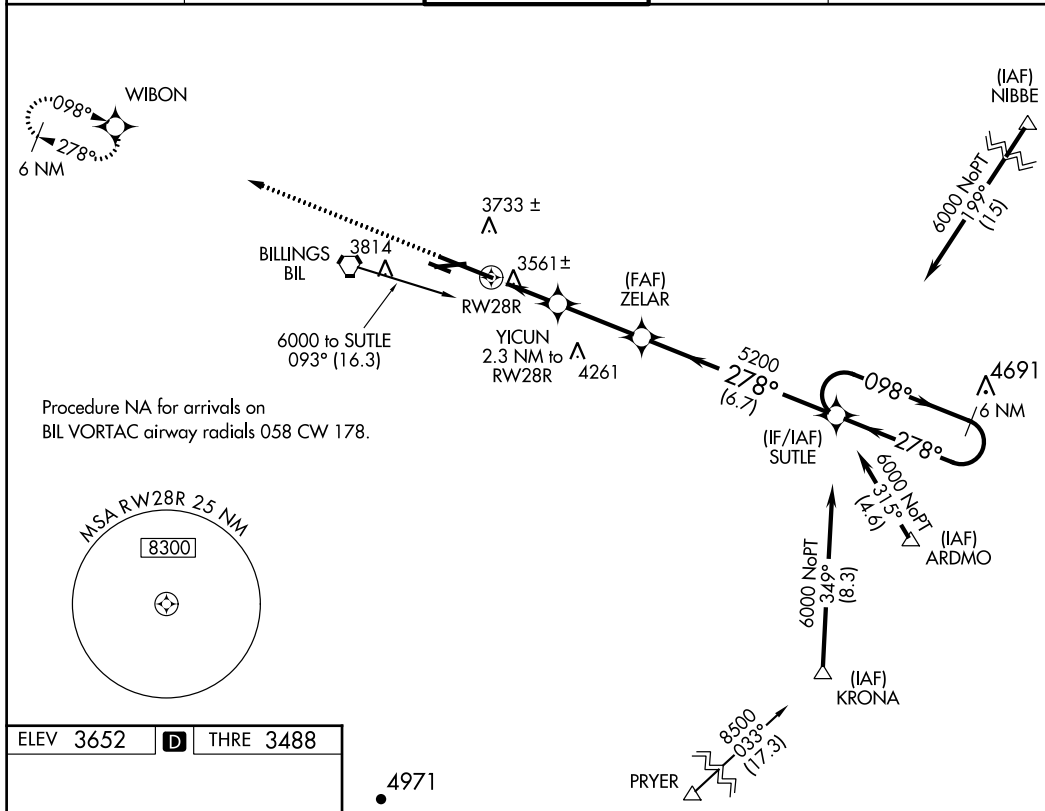

ELEV 3652	<b>D</b>	THRE 3488
-----------	----------	-----------

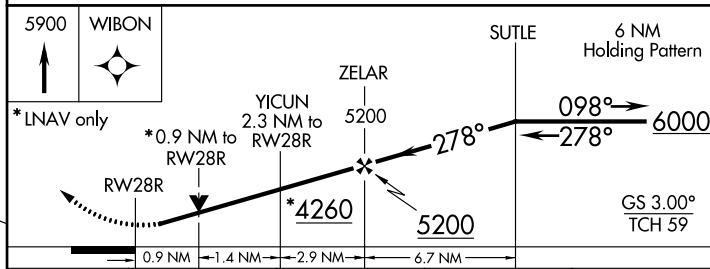
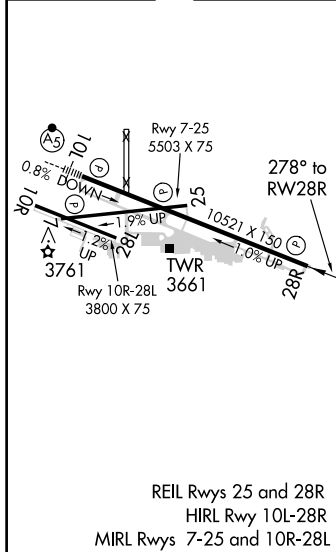

CATEGORY	A	B	C	D
LPV DA		3738- <sup>3</sup> / <sub>4</sub>	250 (100- <sup>3</sup> / <sub>4</sub> )	
LNAV/VNAV DA		3757- <sup>7</sup> / <sub>8</sub>	269 (200- <sup>7</sup> / <sub>8</sub> )	
LNAV MDA		3820-1	332 (200-1)	
CIRCLING	4160-1 508 (600-1)	4180-1 528 (600-1)	4180-1½ 528 (600-1½)	4220-2 568 (600-2)

BILLINGS, MONTANA  
Amdt 2 05APR12

45°48'N-108°33'W

# BILLINGS LOGAN INTL (BIL)

## RNAV (GPS) RWY 28R

FIGURE 212.—RNAV (GPS) RWY 28R (BIL).

BILLINGS, MONTANA

AL-48 (FAA)

13290

VORTAC BIL <b>114.5</b> Chan <b>92</b>	APP CRS <b>262°</b>	Rwy Idg THRE Apt Elev <b>10521</b> <b>3488</b> <b>3652</b>
--	------------------------	---

**VOR/DME RWY 28R**  
BILLINGS LOGAN INTL (BIL)

<p>Visibility reduction by helicopters NA</p>		<p>MISSED APPROACH: Climb to 6000 direct BIL VORTAC and hold, continue climb-in-hold to 6000.</p>		
ATIS <b>126.3</b>	BILLINGS APP CON <b>120.5 284.6</b>	BILLINGS TOWER <b>127.2 257.8</b>	GND CON <b>121.9</b>	CLNC DEL <b>121.9</b>

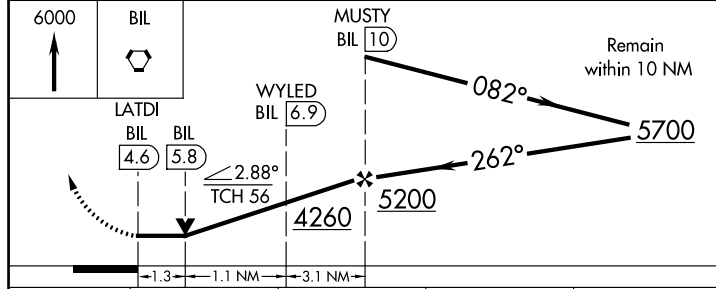
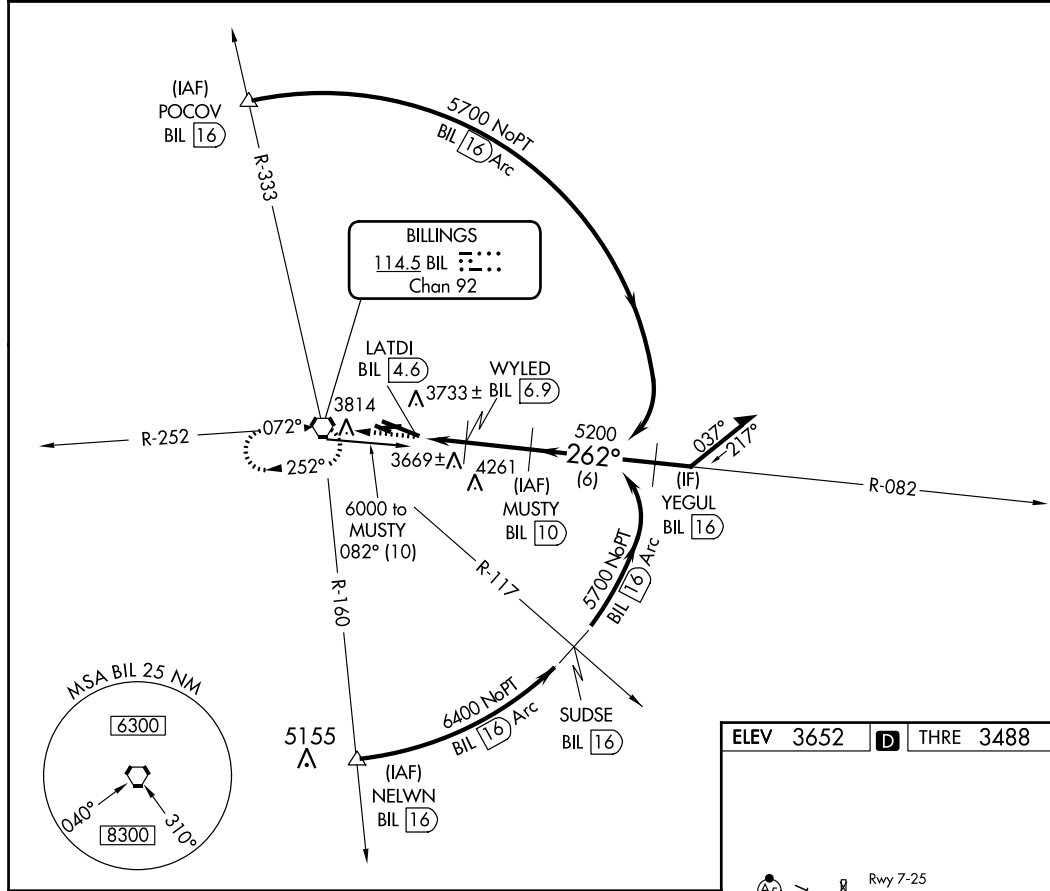

ELEV 3652	D	THRE 3488
-----------	---	-----------

REIL Rwy 25 and 28R  
HIRL Rwy 10L-28R  
MIRL Rwy 7-25 and 10R-28L

CATEGORY	A	B	C	D
S-28R	3940-1	452 (300-1)	3940-1 $\frac{3}{8}$	452 (300-1 $\frac{3}{8}$ )
CIRCLING	4160-1 508 (600-1)	4180-1 528 (600-1)	4180-1 $\frac{1}{2}$ 528 (600-1 $\frac{1}{2}$ )	4220-2 568 (600-2)

BILLINGS, MONTANA  
Amdt 14A 31MAY12

45°48'N-108°33'W

BILLINGS LOGAN INTL (BIL)  
**VOR/DME RWY 28R**

FIGURE 213.—VOR/DME RWY 28R (BIL).

**BILLINGS LOGAN INTL** (BIL) 2 NW UTC-7(-6DT) N45°48.46' W108°32.57' BILLINGS  
 3652 B S4 FUEL 100LL, JET A OX 1, 2, 3, 4 ARFF Index—See Remarks NOTAM FILE BIL H-1E, L-13D  
**Rwy 10L-28R:** H10521X150 (ASPH-GRVD) S-130, D-170, 2S-175, IAP AD  
 2D-285 HIRL  
**Rwy 10L:** MALSR. PAPI(P4L)—GA 3.0° TCH 51'. 0.8% down.  
**Rwy 28R:** REIL. PAPI(P4R)—GA 3.0° TCH 56'. Ground. 1.0% up.  
**Rwy 07-25:** H5503X75 (ASPH-GRVD) S-12.5 MIRL 1.9% up SW  
**Rwy 07:** PAPI(P4L)—GA 3.0° TCH 31'. Ground.  
**Rwy 25:** REIL. PAPI(P4R)—GA 3.0° TCH 36'.  
**Rwy 10R-28L:** H3800X75 (ASPH) S-12.5 MIRL 1.2% up NW  
**Rwy 10R:** Ground.

**RUNWAY DECLARED DISTANCE INFORMATION**

<b>Rwy 07:</b> TORA-5503	TODA-5503	ASDA-5503	LDA-5503
<b>Rwy 10L:</b> TORA-10521	TODA-10521	ASDA-10521	LDA-10521
<b>Rwy 10R:</b> TORA-3800	TODA-3800	ASDA-3800	LDA-3800
<b>Rwy 25:</b> TORA-5503	TODA-5503	ASDA-5503	LDA-5503
<b>Rwy 28L:</b> TORA-3800	TODA-3800	ASDA-3800	LDA-3800
<b>Rwy 28R:</b> TORA-10521	TODA-10521	ASDA-10521	LDA-10521

**AIRPORT REMARKS:** Attended continuously. Rwy 07-25 and Rwy 10R-28L CLOSED to acft over 12,500 lbs. No customs, remote acft parking, ltd ground handling svc. Migratory waterfowl invof arpt. Twy D 35' wide clsd to acft over 12,500 lbs. Class I, ARFF Index C. PPR unscheduled air carrier ops with more than 30 passenger seats ctc arpt ops 406-657-8496. ARFF Index B from 0900-1300Z±. 180° turns Rwy 10L-28R by acft over 25,000 lbs prohibited. For MIRL Rwy 10R-28L and Rwy 07-25, HIRL Rwy 10L-28R, MALSR Rwy 10L and REIL Rwy 25 and Rwy 28R ctc twr.

**WEATHER DATA SOURCES:** ASOS (406) 248-2773 LLWAS.

**COMMUNICATIONS:** ATIS 126.3 UNICOM 122.95  
 RCO 122.55 (GREAT FALLS RADIO)  
 (R) APP/DEP CON 119.2 (EAST) 120.5 (WEST)  
 TOWER 127.2 GND CON 121.9 CLNC DEL 121.9  
 PRE TAXI CLNC 121.9

**AIRSPACE:** CLASS C svc ctc APP CON

**RADIO AIDS TO NAVIGATION:** NOTAM FILE BIL.  
 (H) VORTACW 114.5 BIL Chan 92 N45°48.51' W108°37.48' 077° 3.4 NM to fld. 3811/14E.  
 SAIGE NDB (LOM) 251 BI N45°51.13' W108°41.67' 099° 6.9 NM to fld.  
 ILS 110.3 I-BIL Rwy 10L. Class IB. LOM SAIGE NDB.  
 ILS/DME 111.5 I-BMO Chan 52 Rwy 28R. Class IA. Localizer unusable beyond 20° left and right of course.

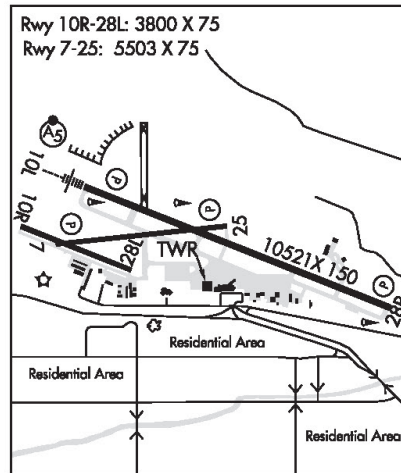

**BLACK BUTTE NORTH** (See WINIFRED on page 106)

**BOULDER** (3U9) 2 S UTC-7(-6DT) N46°12.70' W112°06.46' GREAT FALLS  
 4968 NOTAM FILE GTF  
**Rwy 11-29:** 3675X72 (TURF) 1.6% up W  
**Rwy 11:** Hill.  
**Rwy 29:** Road.  
**AIRPORT REMARKS:** Unattended. No snow removal. Rwy 11-29 thlds marked with faded red cones, edges marked with white cones. -2' drainage ditch +1' berm W side of rwy full length, 43' from Rwy 11-29 centerline.  
**COMMUNICATIONS:** CTAF 122.9

**BOWMAN FLD** (See ANACONDA on page 62)

FIGURE 214.—Excerpt from Chart Supplement.



TRUCKEE, CALIFORNIA

AL-6021 (FAA)

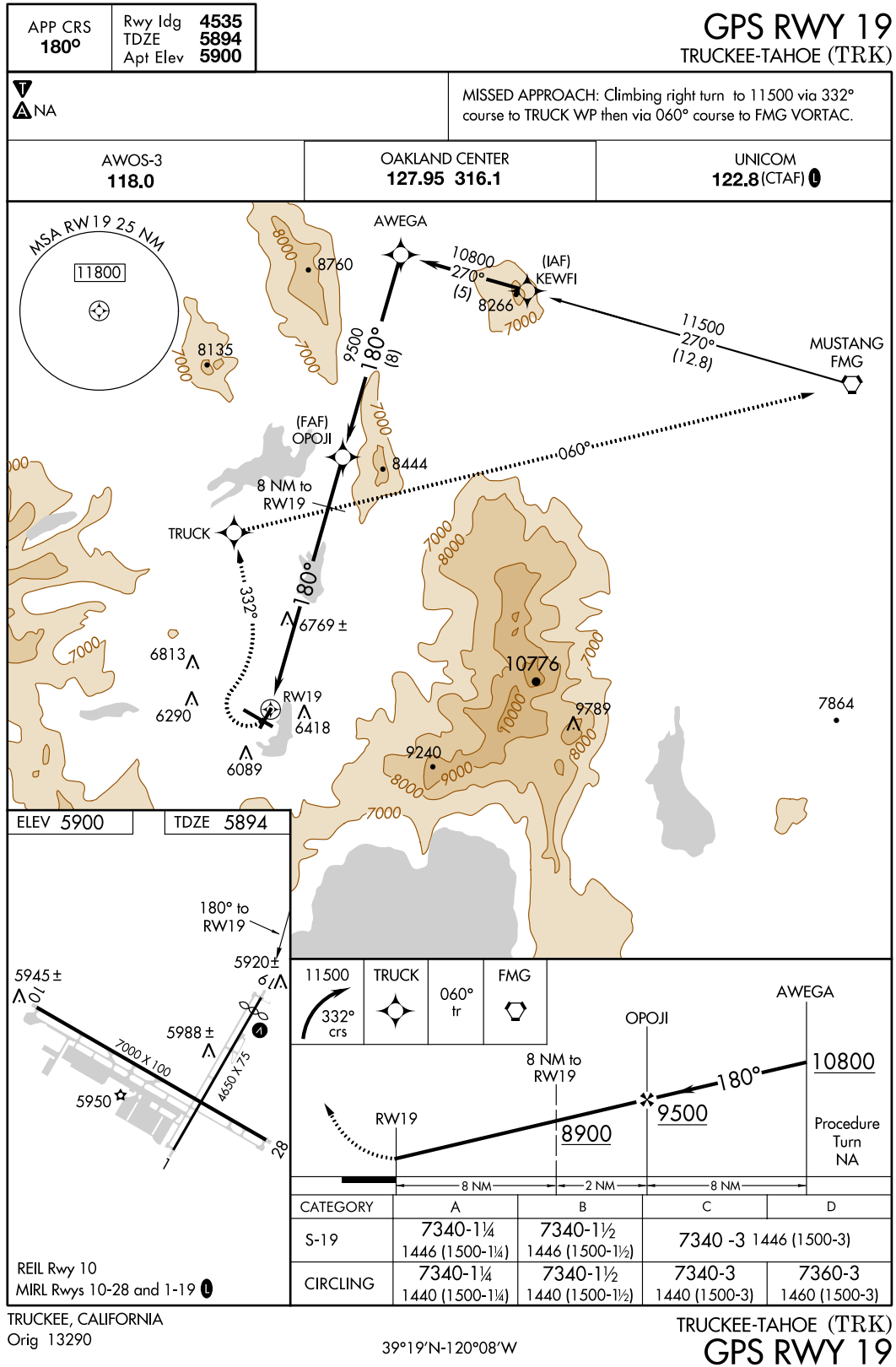

FIGURE 215.—GPS RWY 19 (TRK).

(RENO9.FMG) 16035

**RENO NINE DEPARTURE**

SL-346 (FAA)

RENO/TAHOE INTL (RNO)  
RENO, NEVADA

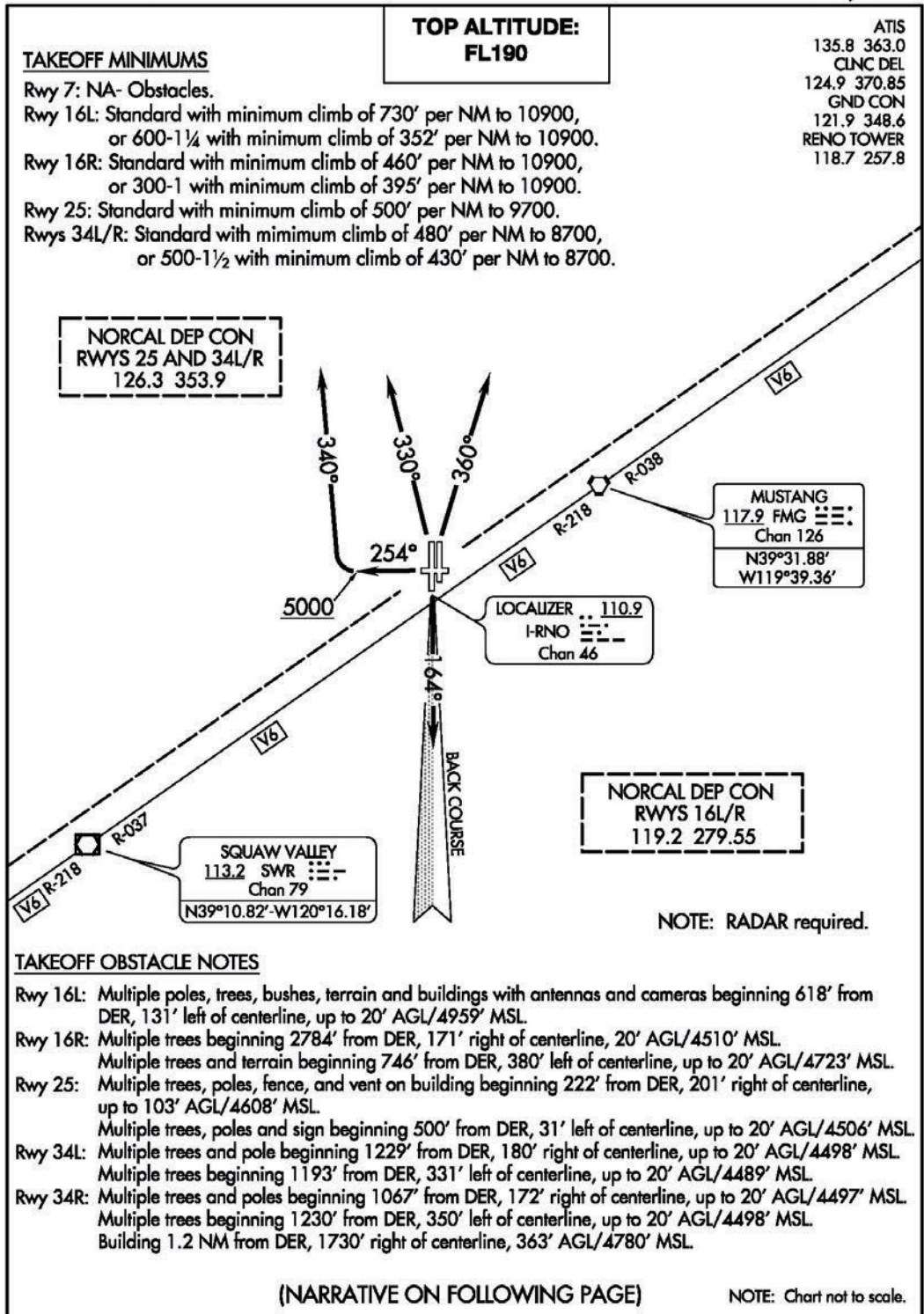

**TAKEOFF OBSTACLE NOTES**

- Rwy 16L: Multiple poles, trees, bushes, terrain and buildings with antennas and cameras beginning 618' from DER, 131' left of centerline, up to 20' AGL/4959' MSL.
- Rwy 16R: Multiple trees beginning 2784' from DER, 171' right of centerline, 20' AGL/4510' MSL.  
Multiple trees and terrain beginning 746' from DER, 380' left of centerline, up to 20' AGL/4723' MSL.
- Rwy 25: Multiple trees, poles, fence, and vent on building beginning 222' from DER, 201' right of centerline, up to 103' AGL/4608' MSL.  
Multiple trees, poles and sign beginning 500' from DER, 31' left of centerline, up to 20' AGL/4506' MSL.
- Rwy 34L: Multiple trees and pole beginning 1229' from DER, 180' right of centerline, up to 20' AGL/4498' MSL.  
Multiple trees beginning 1193' from DER, 331' left of centerline, up to 20' AGL/4489' MSL.
- Rwy 34R: Multiple trees and poles beginning 1067' from DER, 172' right of centerline, up to 20' AGL/4497' MSL.  
Multiple trees beginning 1230' from DER, 350' left of centerline, up to 20' AGL/4498' MSL.  
Building 1.2 NM from DER, 1730' right of centerline, 363' AGL/4780' MSL.

(NARRATIVE ON FOLLOWING PAGE)

NOTE: Chart not to scale.

**RENO NINE DEPARTURE**

(RENO9.FMG) 04FEB16

RENO, NEVADA  
RENO/TAHOE INTL (RNO)

FIGURE 216.—RENO Nine Departure (RENO9.FMG) (RNO).

(RENO9.FMG) 16035

**RENO NINE DEPARTURE**

SL-346 (FAA)

RENO/TAHOE INTL (R.NO)

RENO, NEVADA



## DEPARTURE ROUTE DESCRIPTION

TAKEOFF RUNWAYS 16L/R: Climb on heading 164° and I-RNO localizer south course.

Thence. . . .

TAKEOFF RUNWAY 25: Climb heading 254° to 5000 then climbing right turn heading 340°.

Thence. . . .

TAKEOFF RUNWAYS 34L/R: Climb heading 330° CW 360° as assigned by ATC.

Thence. . . .

. . . .All aircraft maintain FL190 or assigned altitude. Expect clearance to requested altitude 5 minutes after departure. Expect RADAR vectors to assigned route/fix.

LOST COMMUNICATIONS: If not in contact with departure control within one minute after takeoff, maintain assigned heading until passing 10000, thence. . . .

. . . .RUNWAYS 16L/R DEPARTURES: Turn left direct FMG VORTAC, then via assigned route.

. . . .RUNWAYS 25 and 34L/R DEPARTURES: Turn right direct FMG VORTAC, then via assigned route.

**RENO NINE DEPARTURE**

(RENO9.FMG) 04FEB16

RENO, NEVADA  
RENO/TAHOE INTL (R.NO)

FIGURE 216A.—RENO Nine Departure (RENO9.FMG) (RNO).

DES MOINES, IOWA

AL-117 (FAA)

13290

LOC I-VGU <b>111.9</b>	APP CRS <b>129°</b>	Rwy Idg <b>9002</b>
		TDZE <b>921</b>
		Apt Elev <b>958</b>

# ILS or LOC RWY 13

DES MOINES INTL (DSM)

▼ For inoperative MALSR increase S-ILS 13 Cat E visibility to RVR 4000 and S-LOC 13 Cat E visibility to 1½ mile.

MALSR 

MISSED APPROACH: Climb to 1600 then climbing right turn to 3000 direct DSM VORTAC then via DSM R-254 to MIDDLE Int/DSM 12 DME and hold.

ATIS <b>119.55 251.05</b>	DES MOINES APP CON <b>123.9 307.15</b>	DES MOINES TOWER <b>118.3 257.8</b>	GND CON <b>121.9 348.6</b>	CLNC DEL <b>134.15 317.55</b>
------------------------------	---	--	-------------------------------	----------------------------------

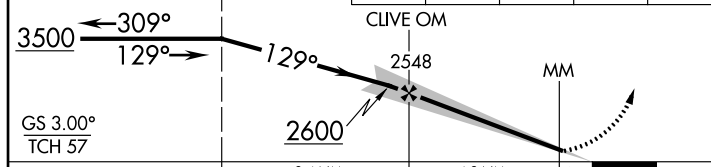
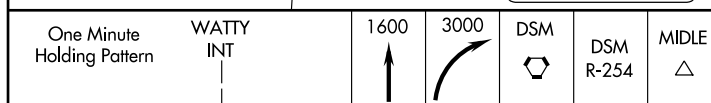
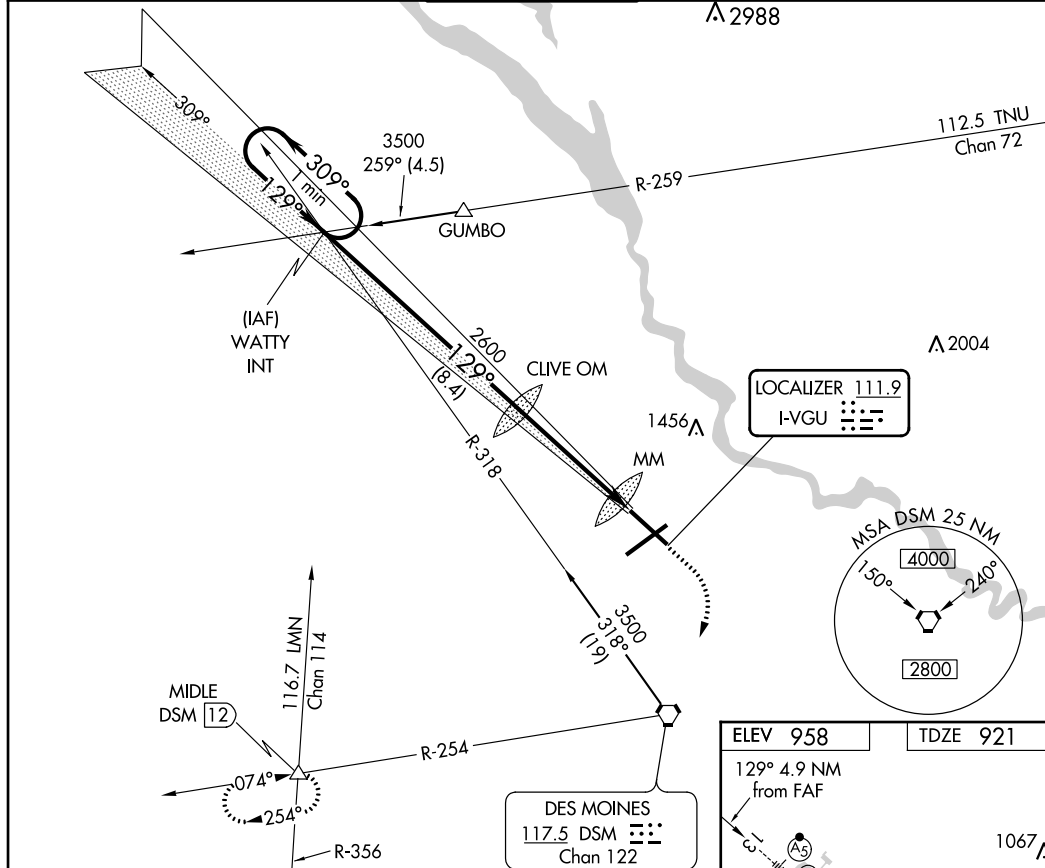

CATEGORY	A	B	C	D	E
S-ILS 13	1121/24 200 (200-½)				
S-LOC 13	1380/24 459 (500-½)	1380/40 459 (500-¾)	1380/50 459 (500-1)		
CIRCLING	1420-1 462 (500-1)	1420-1½ 462 (500-1½)	1520-2 562 (600-2)	1760-2¾ 802 (900-2¾)	

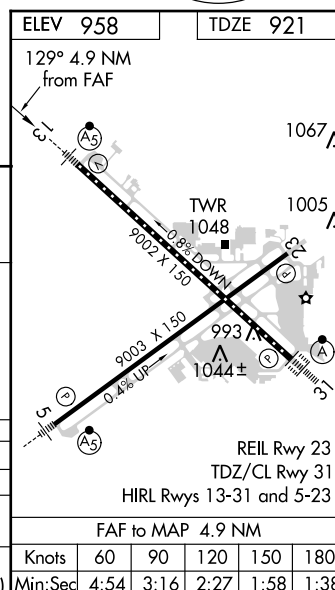

DES MOINES, IOWA  
Amdt 9B 23AUG12

41°32'N-93°40'W

# DES MOINES INTL (DSM)

## ILS or LOC RWY 13

FIGURE 217.—ILS or LOC RWY 13 (DSM).

DES MOINES, IOWA

AL-117 (FAA)

13290

WAAS CH <b>69202</b> <b>W05A</b>	APP CRS <b>051°</b>	Rwy Idg TDZE Apt Elev	<b>9003</b> <b>931</b> <b>958</b>
--	------------------------	-----------------------------	---

# RNAV (GPS) RWY 5

DES MOINES INTL (DSM)

**▽** DME/DME RNP-0.3 NA.  
**▲** For uncompensated Baro-VNAV systems, LNAV/VNAV NA below -16°C (4°F) or above 48°C (116°F).  
 If local altimeter setting not received, use Ankeny Rgnl altimeter setting and increase all DAs/MDAs 40 feet.  
 Baro-VNAV and VDP NA when using Ankeny Rgnl altimeter setting.  
 For inoperative MALSR, increase LPV all Cats. visibility to RVR 5000 and LNAV/VNAV all Cats. visibility to RVR 6000 and LNAV Cat. D visibility to RVR 6000.

MALSR

MISSED APPROACH: Climb to 3100 direct IOWAA and hold.

ATIS <b>119.55 251.05</b>	DES MOINES APP CON <b>123.9 307.15</b>	DES MOINES TOWER <b>118.3 257.8</b>	GND CON <b>121.9 348.6</b>	CLNC DEL <b>134.15 317.55</b>
------------------------------	---	--	-------------------------------	----------------------------------

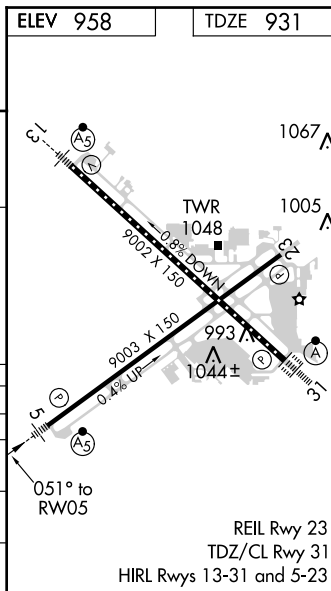
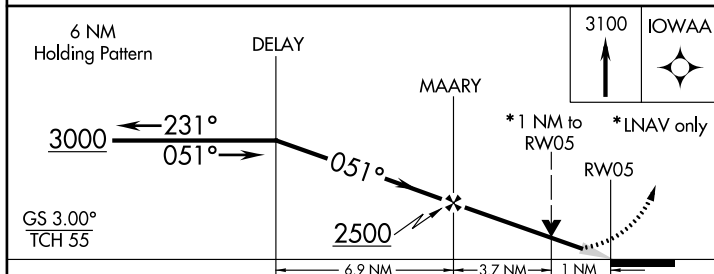
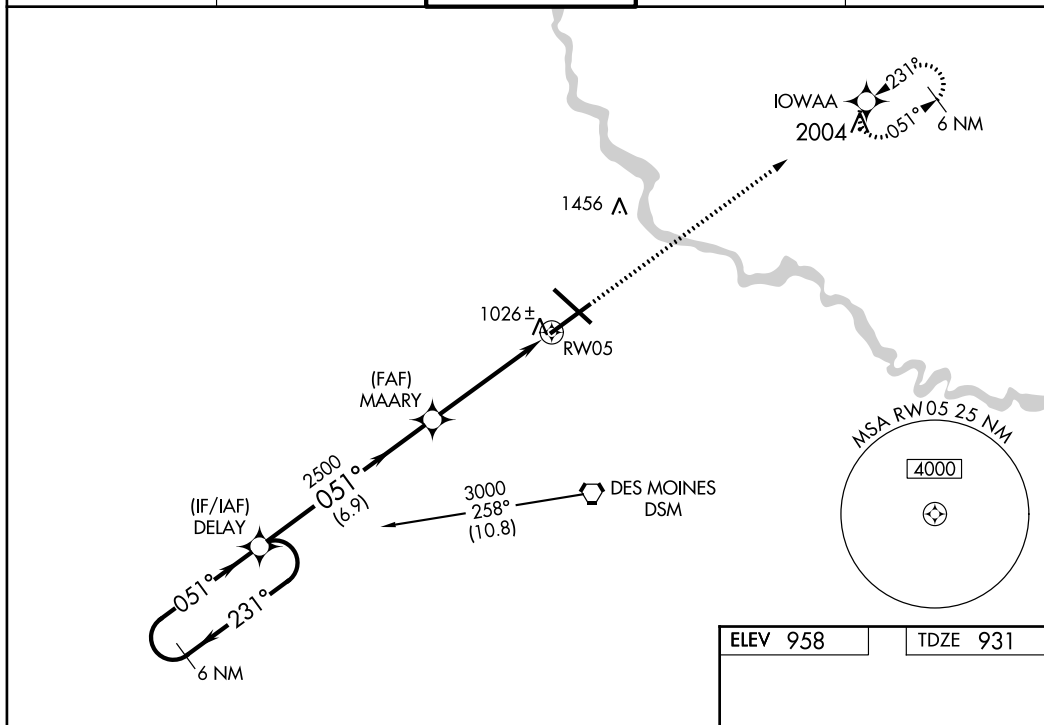

CATEGORY	A	B	C	D
LPV DA		1188/24	257 (300-1/2)	
LNAV/VNAV DA		1385/50	454 (500-1)	
LNAV MDA		1320/24	389 (400-1/2)	
CIRCLING	1420-1	462 (500-1)	1420-1 1/2 462 (500-1 1/2)	1520-2 562 (600-2)

DES MOINES, IOWA  
Amdt 1A 28JUN12

41°32'N-93°40'W

# DES MOINES INTL (DSM)

## RNAV (GPS) RWY 5

FIGURE 218.—RNAV (GPS) RWY 5 (DSM).

RIVERSIDE/RUBIDOUX, CALIFORNIA

AL-9974 (FAA)

13290

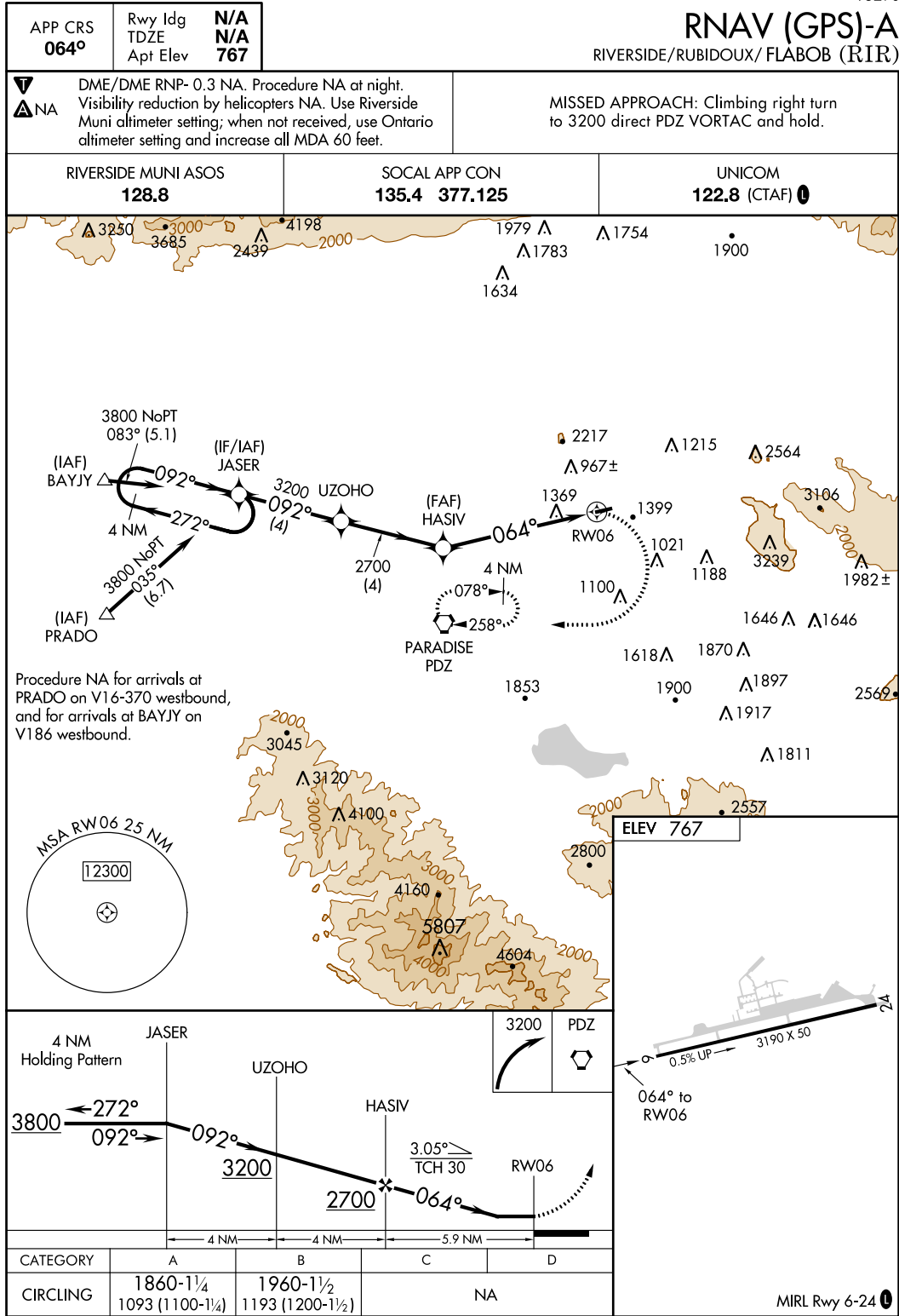

RIVERSIDE/RUBIDOUX, CALIFORNIA

RIVERSIDE/RUBIDOUX/ FLABOB (RIR)

Orig 25AUG11

33°59'N-117°25'W

**RNAV (GPS)-A**

FIGURE 219.—RNAV (GPS)-A (RIR).

L11



## TAKEOFF MINIMUMS AND (OBSTACLE) DEPARTURE PROCEDURES



13234

### RIVERSIDE/RUBIDOUX, CA

FLABOB (RIR)

ORIG 11181 (FAA)

TAKEOFF MINIMUMS: **Rwy 6**, std. w/min. climb of 670' per NM to 4000 or 400-2 w/min. climb of 480' per NM to 4000 or 2100-3 for climb in visual conditions. **Rwy 24**, std. w/min. climb of 630' per NM to 3000 or 800-2¾ w/min. climb of 305' per NM to 4600 or 2100-3 for climb in visual conditions.

DEPARTURE PROCEDURE: **Rwy 6**, climb via heading 064° to 4000 then right turn direct PDZ VORTAC, or for climb in visual conditions cross Flabob Airport Southwest bound at or above 2700 then via PDZ R-039 to PDZ VORTAC. **Rwy 24**, climb via heading 244° and PDZ R-031 to PDZ VORTAC, or for climb in visual conditions cross Flabob airport Southwest bound at or above 2700 then via PDZ R-039 to PDZ VORTAC.

All aircraft climb in PDZ VORTAC holding pattern (hold East, right turns, 258° inbound) to cross PDZ VORTAC at or above MEA for direction of flight before proceeding on course.

NOTE: **Rwy 6**, trees beginning 3763' from DER, 1152' right of centerline, up to 40' AGL/1119' MSL. **Rwy 24**, antenna on tank 6193' from DER, 2057' right of centerline, 38' AGL/1237' MSL. Trees beginning 2494' from DER, 434' right of centerline, up to 40' AGL/1519' MSL. Pole 6261' from DER, 1950' right of centerline, 30' AGL/1230' MSL. Building 1.52 NM from DER, 1154' right of centerline, up to 29' AGL/1369' MSL. Antenna on tank 1.26 NM from DER, 2047' right of centerline, 54' AGL/1254' MSL. Tank 4043' from DER, 794' right of centerline, 66' AGL/961' MSL. Tree 1.79 NM from DER, 434' right of centerline, 58' AGL/1138' MSL.

### SAN BERNARDINO, CA

SAN BERNARDINO INTL (SBD)

ORIG 93343 (FAA)

TAKEOFF MINIMUMS: **Rwy 6**, CAT A,B 2100-2 or std. with a min. climb of 340' per NM to 3700. CAT C,D 3100-2 or std. with a min. climb of 480' per NM to 4600.

DEPARTURE PROCEDURE: **Rwy 6**, climbing right turn. **Rwy 24**, climbing left turn. **All aircraft** climb direct PDZ VORTAC. Aircraft departing PDZ R-091 CW R-140 and R-231 CW R-280 climb on course. All others continue climb in PDZ holding pattern (Hold NE, right turns, 210° inbound) to cross PDZ VORTAC at or above: R-281 CW R-090, 7700; R-141 CW R-230, 4900.

### SAN CLEMENTE ISLAND NALF (FREDERICK SHERMAN FLD)(KNUC)

SAN CLEMENTE ISLAND, CA . . . . . 12208

**Rwy 5**: Diverse departures authorized 090° to 233° CCW.

**Rwy 23**: Diverse departures authorized 160° to 053° CW.

TAKE-OFF OBSTACLES: **Rwy 5**, Pylon 198' MSL, 44' from DER, 274' left of centerline. Terrain 192' MSL, 50' from DER, 500' right of centerline. Terrain 194' MSL, 264' from DER, 509' right of centerline. Terrain 209' MSL, 824' from DER, 721' right of centerline. Terrain 199' MSL, 957' from DER, 612' right of centerline.

13234



## TAKEOFF MINIMUMS AND (OBSTACLE) DEPARTURE PROCEDURES



### SAN DIEGO, CA

BROWN FIELD MUNI (SDM)

AMDT 4 10154(FAA)

TAKEOFF MINIMUMS: **Rwy 8L**, std. w/ min. climb of 570' per NM to 3100. **Rwys 8R,26L**, NA - ATC.

DEPARTURE PROCEDURE: **Rwy 8L**, climbing left turn, thence...**Rwy 26R**, climbing right turn, thence...  
...via heading 280° to intercept MZB R-160 to MZB VORTAC.

NOTE: **Rwy 26R**, tree 1284' from DER, 778' left of centerline, 52' AGL/561' MSL.

### MONTGOMERY FIELD (MYF)

AMDT 3A 10210 (FAA)

TAKEOFF MINIMUMS: **Rwy 5**, 1500-2 or std. with a min. climb of 290' per NM to 1700.

DEPARTURE PROCEDURE: **Rwys 5, 10L/R**, climbing right turn. **Rwys 28L/R**, climbing left turn. **All aircraft** climb direct to MZB VORTAC. Aircraft departing MZB R-090 CW R-360 climb on course. All others climb in MZB holding pattern (W, right turns, 075° inbound) to cross MZB VORTAC at or above 1800.

NOTE: **Rwy 5**, trees and bushes beginning 244' from DER, 161' left of centerline, up to 99' AGL/524' MSL. Tree 1287' from DER, 103' right of centerline, up to 49' AGL/474' MSL. **Rwy 23**, tree, flag pole, and transmission towers beginning 1594' from DER, 82' right of centerline, up to 125' AGL/545' MSL. Transmission towers beginning 2627' from DER, 414' left of centerline up to 125' AGL/524' MSL. **Rwy 10L**, trees beginning 230' from DER, 494' left of centerline, up to 57' AGL/486' MSL. Trees beginning 1172' from DER, 591' right of centerline, up to 69' AGL/488' MSL. **Rwy 10R**, rod on electrical equipment 40' from DER, 66' left of centerline, 7' AGL/426' MSL. Trees beginning 2107' from DER, 199' right of centerline, up to 69' AGL/488' MSL. **Rwy 28L**, bushes and poles beginning 35' from DER, 160' right of centerline, up to 37' AGL/451' MSL. Trees beginning 1008' from DER, 7' left of centerline, up to 37' AGL/451' MSL. **Rwy 28R**, bushes, trees, and poles beginning 34' from DER, 162' left of centerline, up to 38' AGL/451' MSL. Trees, signs, and poles beginning 768' from DER, 98' right of centerline, up to 67' AGL/488' MSL.

FIGURE 220.—Takeoff Minimums and (Obstacle) Departure Procedures.

LOS ANGELES, CALIFORNIA

AL-237 (FAA)

13290

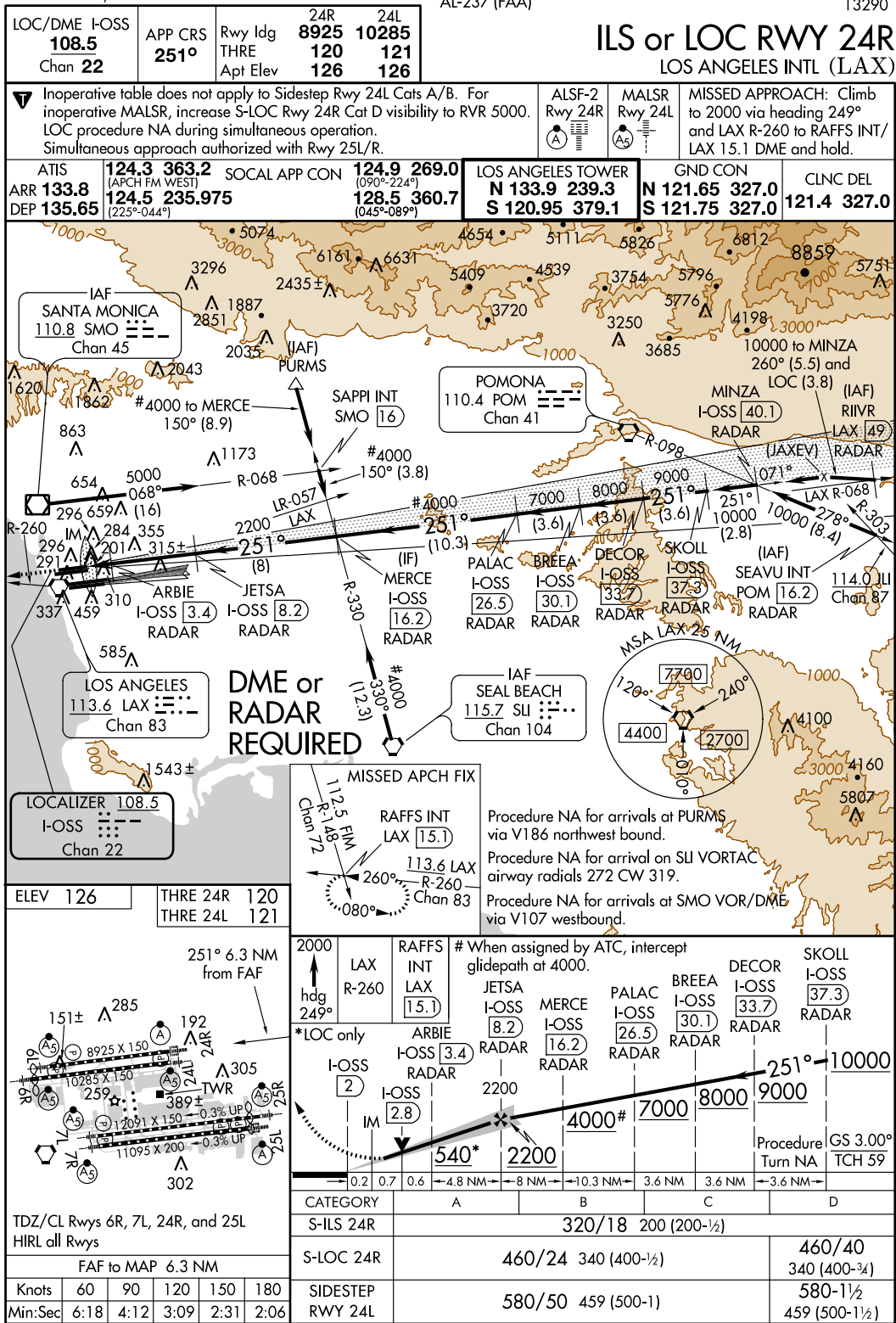

LOS ANGELES, CALIFORNIA

LOS ANGELES INTL (LAX)

Amdt 24A 26JUL12

33°57'N-118°24'W

**ILS or LOC RWY 24R**

FIGURE 221.—ILS or LOC RWY 24R (LAX).



BURBANK, CALIFORNIA

AL-67 (FAA)

13290

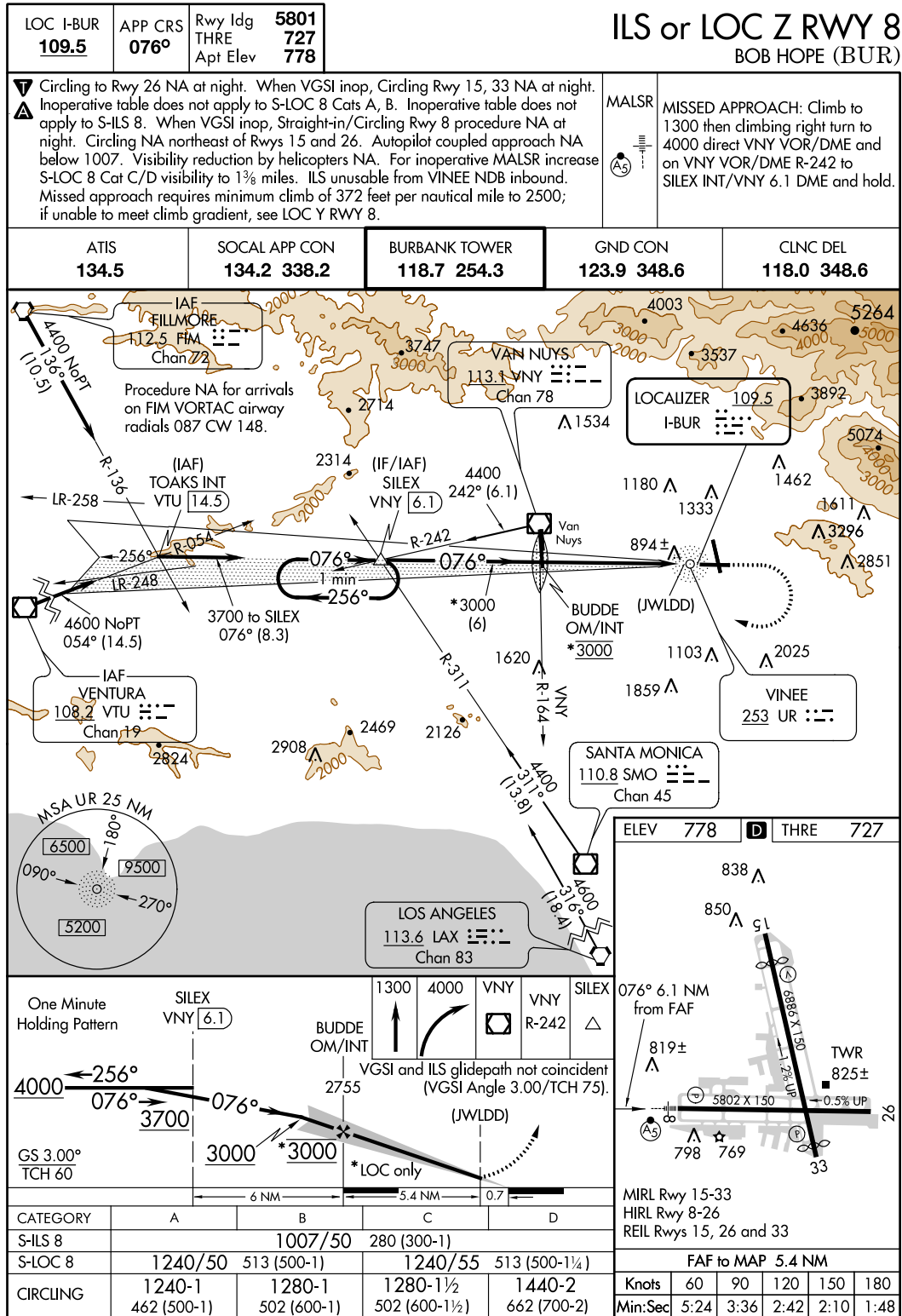

BURBANK, CALIFORNIA  
Amdt 37 05APR12

34°12'N-118°22'W

BOB HOPE (BUR)  
**ILS or LOC Z RWY 8**

FIGURE 222.—ILS or LOC Z RWY 8 (BUR).

DES MOINES, IOWA

AL-117 (FAA)

13290

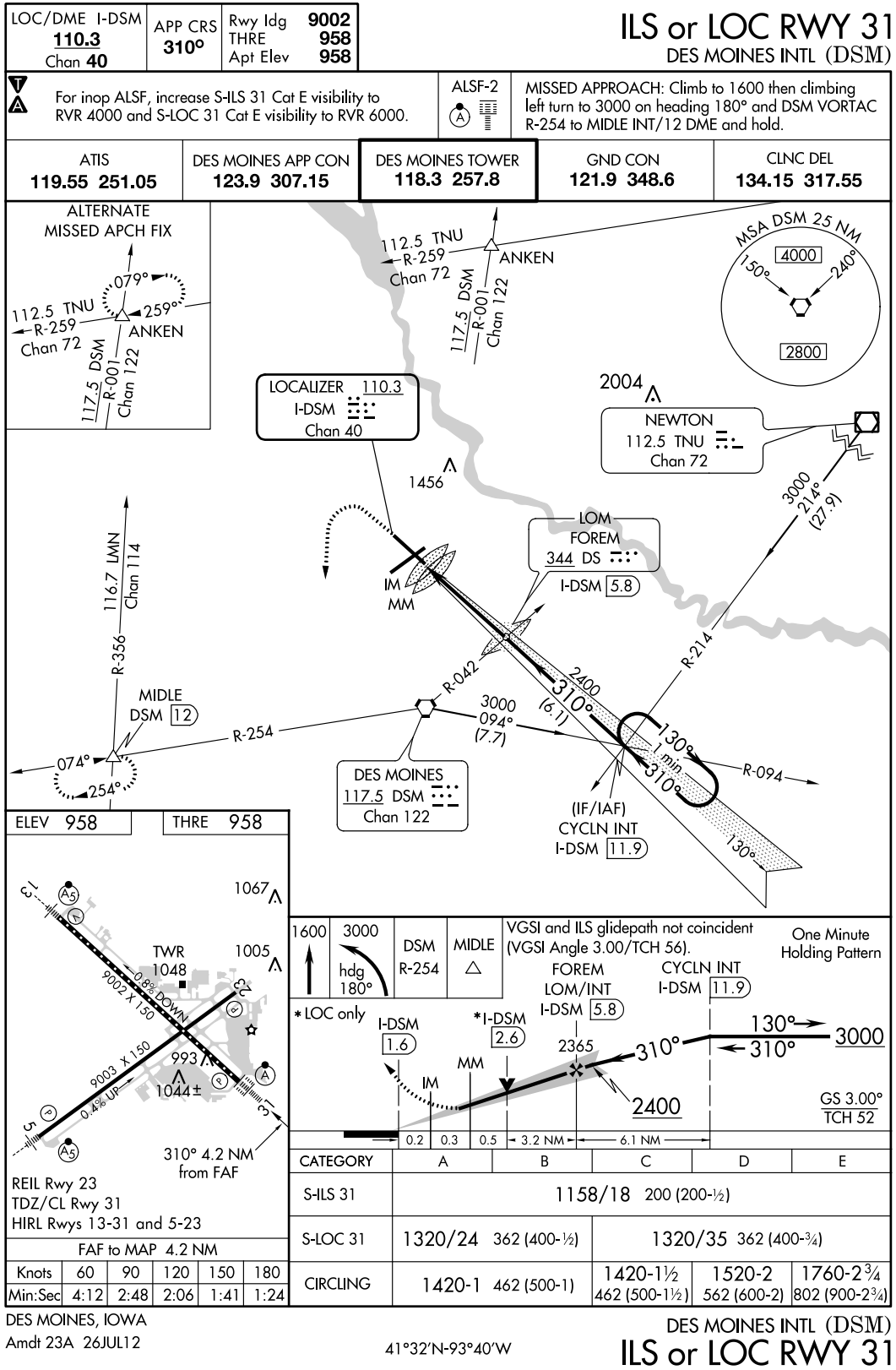

DES MOINES, IOWA  
Amdt 23A 26JUL12

41°32'N-93°40'W

DES MOINES INTL (DSM)  
**ILS or LOC RWY 31**

FIGURE 223.—ILS or LOC RWY 31 (DSM).

LEADVILLE, COLORADO

AL-9146 (FAA)

APP CRS <b>161°</b>	Rwy Idg <b>6400</b>
	TDZE <b>9928</b>
	Apt Elev <b>9928</b>

**GPS RWY 16**  
LEADVILLE/LAKE COUNTY (LXV)

▲ NA MISSED APPROACH: Climb to 16000 via 158° course to MORYU WP, then via 106° course to TERRO WP and hold.

ASOS <b>118.375</b>	DENVER CENTER <b>119.85 363.15</b>	UNICOM <b>122.8 (CTAF) 0</b>
------------------------	---------------------------------------	---------------------------------

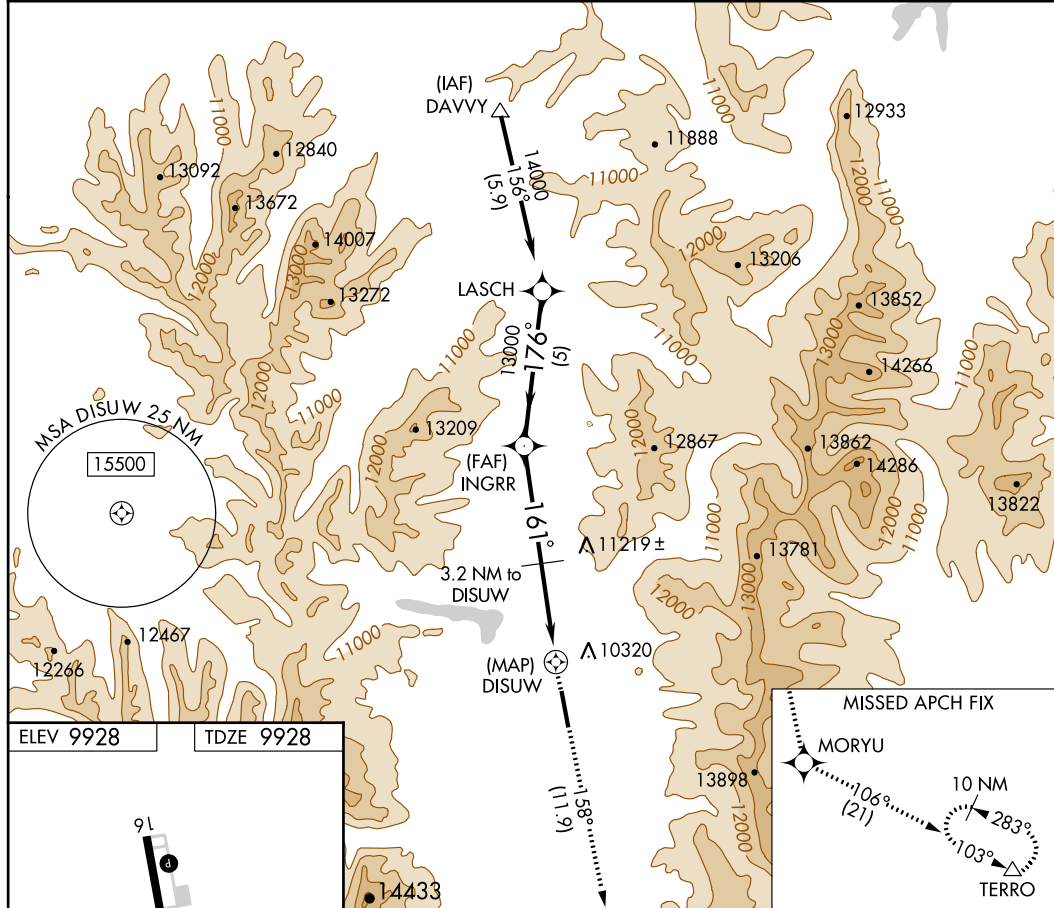

ELEV 9928 TDZE 9928

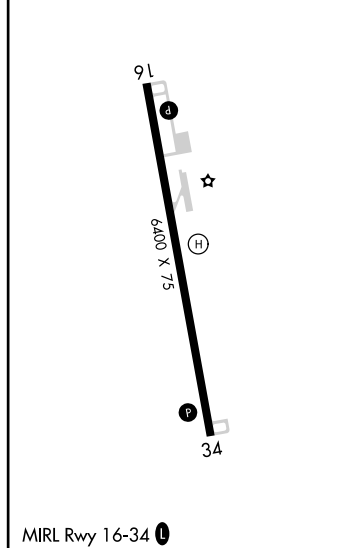

VGSI and descent angles not coincident (VGSI Angle 3.00/TCH 45).  
LASCH 14000 INGRR 13000 DISUW 11540  
158° crs MORYU 106° crs TERRO

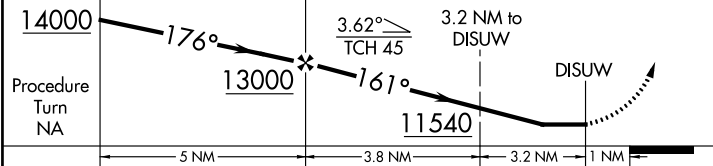

CATEGORY	A	B	C	D
S-16	11360-1¼ 1432 (1500-1¼)	11360-1½ 1432 (1500-1½)	NA	
CIRCLING	11360-1¼ 1432 (1500-1¼)	11360-1½ 1432 (1500-1½)	NA	

LEADVILLE, COLORADO  
Orig 12320

39°13'N - 106°19'W

LEADVILLE/LAKE COUNTY (LXV)  
**GPS RWY 16**

FIGURE 224.—GPS RWY 16 (LXV).

L8			
T	TAKEOFF MINIMUMS AND (OBSTACLE) DEPARTURE PROCEDURES	T	
13262	<p><b>KREMMLING, CO</b> MC ELROY AIRFIELD (20V) TAKEOFF MINIMUMS: <b>Rwy 9</b>, 2600-2 or std. with a min. climb of 370' per NM to 12700. <b>Rwy 27</b>, 3200-2 or std. with a min. climb of 500' per NM to 12700. DEPARTURE PROCEDURE: <b>Rwy 9</b>, climb runway heading to 10000, then climbing right turn. <b>Rwy 27</b>, climb runway heading to 10900, then climbing left turn. <b>All aircraft</b> proceed direct RLG VOR/DME. Continue climb to 13,000 in RLG holding pattern (hold SW, left turns, 051° inbound).</p> <p><b>LA JUNTA, CO</b> LA JUNTA MUNI (LHX) AMDT 3 03191 (FAA) DEPARTURE PROCEDURE: <b>Rwy 8</b>, climb via heading 080°. <b>Rwy 12</b>, climb via heading 120°. <b>Rwy 26</b>, turn left heading 160°. <b>Rwy 30</b>, turn left heading 140°. <b>All aircraft</b>, intercept LAA R-238 (V210) to LAA VOR/DME. When at or above 8000 proceed on course.</p> <p><b>LAMAR, CO</b> LAMAR MUNI (LAA) DEPARTURE PROCEDURE: <b>Rwys 8,36</b>, turn left. <b>Rwy 18</b>, turn left/right. <b>Rwy 26</b>, turn right. Direct LAA VOR/DME. Aircraft departing LAA R-048 CW R-118 climb on course. All others continue climbing in LAA holding pattern (N, right turns, 169° inbound) to 6000 before proceeding on course.</p> <p><b>LAS CRUCES, NM</b> LAS CRUCES INTL (LRU) AMDT 1 96340 (FAA) DEPARTURE PROCEDURE: <b>Rwys 4, 8</b>, climbing right turn. <b>Rwy 12</b>, CAT A,B, climb runway heading CAT C,D, NA. <b>Rwys 22, 26</b>, climbing left turn. <b>Rwy 30</b>, climbing runway heading to 5100 then climbing left turn. <b>All aircraft</b> climb direct HAWKE LOM. Continue climb in HAWKE holding pattern (SE, left turns, 304° inbound) to cross HAWKE LOM at or above 10000 before proceeding on course.</p> <p><b>LAS VEGAS, NM</b> LAS VEGAS MUNI (LVS) AMDT 1 06103 (FAA) DEPARTURE PROCEDURE: <b>Rwys 2, 14</b> turn left/right. <b>Rwy 20</b>, turn left (except via FTI R-215). <b>Rwy 32</b>, turn right. Departures via FTI VORTAC R-001 CW R-215 climb on course. Departures via FTI VORTAC R-216 CW R-360 proceed direct FTI VORTAC. Climb in FTI VORTAC holding pattern (hold north, left turn, 192° inbound) to cross FTI at airway MEA/MCA. (NOTE: climb in hold not authorized for turbojet aircraft).</p> <p><b>LEADVILLE, CO</b> LAKE COUNTY (LXV) AMDT 2 08101 (FAA) DEPARTURE PROCEDURE: <b>Rwy 16</b>, use LOZUL (RNAV) DEPARTURE. <b>Rwy 34</b>, use DAVVY (RNAV) DEPARTURE.</p>	<p><b>LONGMONT, CO</b> VANCE BRAND (LMO) AMDT 1 12040 (FAA) DEPARTURE PROCEDURE: <b>Rwy 11</b>, climbing left turn to intercept GLL VOR/DME R-221 to 7000 ... <b>Rwy 29</b>, climbing right turn to intercept GLL VOR/DME R-221 to 7000 ... ... All aircraft proceed on GLL R-221 to GLL VOR/DME. Cross GLL VOR/DME at or above MEA/MCA for route of flight. NOTE: <b>Rwy 11</b>, trees beginning 130' from DER, 191' right of centerline, up to 80' AGL/5119' MSL. Vehicles on roadway, 449' from DER, 395' left and right of centerline, 17' AGL/5046' MSL. Trees beginning 1383' from DER, 434' left of centerline, up to 80' AGL/5109' MSL. <b>Rwy 29</b>, trees beginning 4105' from DER, 220' left of centerline, up to 80' AGL/5189' MSL.</p> <p><b>LOS ALAMOS, NM</b> LOS ALAMOS (LAM) AMDT 1 12152 (FAA) TAKEOFF MINIMUMS: <b>Rwy 27</b>, NA-obstacles and airport restriction. DEPARTURE PROCEDURE: <b>Rwy 9</b>, climb heading 092° to intercept SAF R-354. Northbound climbing to 11000 on V83. Southbound climbing to 9000 on V83. NOTE: <b>Rwy 9</b>, terrain and trees beginning 101' from DER, 178' left and right of centerline, up to 60' AGL/7139' MSL.</p> <p><b>LOVINGTON, NM</b> LEA COUNTY-ZIP FRANKLIN MEMORIAL (E06) AMDT 1 99364 (FAA) DEPARTURE PROCEDURE: <b>Rwy 3</b>, climb runway heading to 4700 before turning on course. NOTE: <b>Rwy 12</b>, 35' AGL power line 1250' from DER 150' right of centerline. <b>Rwy 21</b>, 40' AGL tower 936' from DER 273' right of centerline. <b>Rwy 30</b>, 50' AGL windmill 1800' from DER 50' right of centerline.</p> <p><b>MEEKER, CO</b> MEEKER (EEO) AMDT 1 08157 (FAA) TAKEOFF MINIMUMS: <b>Rwys 3, 21</b>, 4100-3 for climb in visual conditions. DEPARTURE PROCEDURE: <b>Rwys 3, 21</b>, for climb in visual conditions: cross Meeker Airport at or above 10500 before proceeding on course. NOTE: <b>Rwy 21</b>, multiple trees beginning 843' from DER, 20' left of centerline, up to 100' AGL/7190' MSL. Multiple trees beginning 227' from DER, 187' right of centerline, up to 100' AGL/6862' MSL.</p> <p><b>MONTE VISTA, CO</b> MONTE VISTA MUNI (MVI) AMDT 3 01025 (FAA) DEPARTURE PROCEDURE: <b>Rwy 2</b>, climbing right turn. <b>Rwy 20</b>, climbing left turn. <b>All aircraft</b>, climb direct ALS VORTAC, continue climb in ALS holding pattern (SE, right turns, 301° inbound) to cross ALS VORTAC at or above 11000, except V210 westbound 11200 and J102 northeast bound 13700, before proceeding enroute.</p>	13262
T	TAKEOFF MINIMUMS AND (OBSTACLE) DEPARTURE PROCEDURES	T	

FIGURE 225.—Takeoff Minimums and (Obstacle) Departure Procedures.

242

## COLORADO

**LAMAR MUNI** (LAA) 3 SW UTC-7(-6DT) N38°04.18' W102°41.31'

3706 B S4 FUEL 100LL, JET A OX 1, 3 NOTAM FILE LAA

RWY 18-36: H6304X100 (CONC-GRVD) S-45, D-55, 2D-100 MIRL

0.4% up S

RWY 18: REIL. VASI(V4L)—GA 3.0° TCH 45'. Road.

RWY 36: REIL. PAPI(P4L)—GA 3.0° TCH 45'. Hill.

RWY 08-26: H5001X60 (ASPH-PFC) S-35, D-50, 2D-95 MIRL

RWY 08: PAPI(P2L)—GA 3.0° TCH 30'. Road.

RWY 26: REIL. PAPI(P2L)—GA 3.0° TCH 31'. Fence.

**AIRPORT REMARKS:** Attended 1500-0100Z $\ddagger$ . For svc after hrs phone 719-336-7701. Be alert, intensive USAF student training in vol of Colorado Springs and Pueblo Colorado. Rwy 18-36 now has distance remaining signs. Twr 500' AGL 4.5 mile SE unlighted. ACTIVATE MIRL Rwy 08-26 and Rwy 18-36—CTAF. NOTE: See Special Notices—Aerobatic Operations in Colorado. USAF 306 FTG Flight Training Areas, Vicinity of Colorado Springs and Pueblo Colorado.

**WEATHER DATA SOURCES:** ASOS 135.625 (719) 336-3854.**COMMUNICATIONS:** CTAF/UNICOM 122.8

DENVER CENTER APP/DEP CON 133.4

**RADIO AIDS TO NAVIGATION:** NOTAM FILE LAA.

(H) VORW/DME 116.9 LAA Chan 116 N38°11.83'

W102°41.25' 168° 7.6 NM to fld. 3944/12E.

WICHITA

H-5A, L-10G

IAP

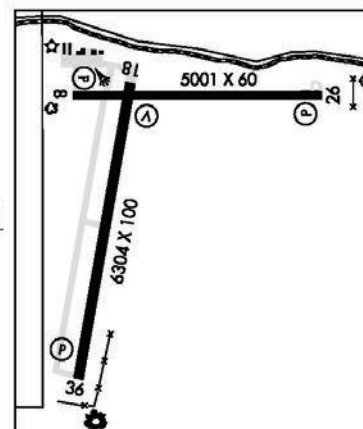
**LAS ANIMAS****CITY OF LAS ANIMAS – BENT CO** (7V9) 1 S UTC-7(-6DT) N38°03.24' W103°14.31'

3915 S4 NOTAM FILE DEN

RWY 08-26: H3870X40 (ASPH) S-5 HIRL 0.4% up W

RWY 08: REIL. Fence.

RWY 26: REIL. Road.

**AIRPORT REMARKS:** Attended Mon-Sat 1500-0000Z $\ddagger$ . Be alert, intensive USAF student training in vol of Colorado Springs and Pueblo Colorado. Rwy 26 has +30' poles 105' from thld 210' left of extd rwy centerline, +15' tank 321' from rwy end 270' right of centerline. Thld lghts NSTD; three lghts each end. Thld lghts OTS indef. Rwy 08 thld lghts 23' from thld. Rwy 26 thld lghts 12' from thld. Rwy 08 numbers located 216' from pavement end, Rwy 08-26 numbers smaller than standard, no centerline markings. ACTIVATE HIRL Rwy 08-26—CTAF. Med ints 5 clicks, high ints 7 clicks. See Special Notices—USAF 306 FTG Flight Training Areas, Vicinity of Colorado Springs and Pueblo Colorado.

**COMMUNICATIONS:** CTAF 122.9**RADIO AIDS TO NAVIGATION:** NOTAM FILE LAA.

LAMAR (H) VORW/DME 116.9 LAA Chan 116 N38°11.83' W102°41.25' 240° 27.5 NM to fld. 3944/12E.

WICHITA

L-10F

**LEACH** (See CENTER on page 220)**LEADVILLE****LAKE CO** (LXV) 2 SW UTC-7(-6DT) N39°13.17' W106°18.99'

9934 B FUEL 100LL, JET A NOTAM FILE LXV

RWY 16-34: H6400X75 (ASPH) S-20, D-20 MIRL

RWY 16: PAPI(P2L)—GA 3.0° TCH 45'. Rgt tfc.

RWY 34: PAPI(P2L)—GA 3.0° TCH 45'.

**AIRPORT REMARKS:** Attended May-Oct 1430-2330Z $\ddagger$ , Nov-Apr 1500-2330Z $\ddagger$ . For svc after hrs call sheriff dispatch 719-486-1249. PPR for svc after hrs call 719-293-5110. Rwy 34 has +50' power lines 750' from right of thld. Twy C and old ramp have potholes and loose aggregate. All twys and new ramp area marked with blue and white reflectors. ACTIVATE MIRL Rwy 16-34 and PAPI Rwy 16 and Rwy 34—CTAF.

**WEATHER DATA SOURCES:** ASOS 118.375 (719) 486-2735.**COMMUNICATIONS:** CTAF/UNICOM 122.8

DENVER CENTER APP/DEP CON 119.85

**RADIO AIDS TO NAVIGATION:** NOTAM FILE DEN.

RED TABLE (H) VORW/DME 113.0 DBL Chan 77 N39°26.36'

W106°53.68' 104° 30.0 NM to fld. 11800/12E.

**HELIPAD H1:** H150X100 (ASPH-CONC)

**HELIPORT REMARKS:** Rwy H1 has 6-8 inch lip all around edges, concrete has longitudinal and corner cracking. Rwy H1 has 20' to 30' trees 130' east of pad.

DENVER

H-3F, 5A, L-9E

IAP

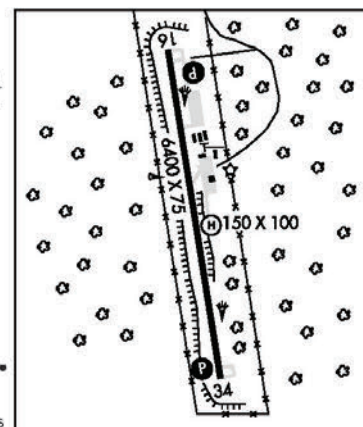

FIGURE 226.—Excerpt from Chart Supplement.

Appendix 2

DENVER, COLORADO

AL-5715 (FAA)

13262

LOC/DME I-APA <b>111.3</b> Chan 50	APP CRS <b>350°</b>	Rwy Idg THRE Apt Elev	35R <b>10001</b> <b>5885</b>	35L <b>7000</b> <b>5869</b> <b>5885</b>	<b>ILS or LOC RWY 35R</b> DENVER/ CENTENNIAL (APA)
<p>▼ Inoperative table does not apply to S-LOC 35R. When Rwy 35L VGSI inop, Sidestep to Rwy 35L NA at night. When Rwy 35L VGSI inop, Circling to Rwy 35L NA at night. ADF or DME required.</p>		<p>▲ MALSR</p>		<p>MISSED APPROACH: Climb to 7400 then climbing right turn to 9000 on I-APA south course to CASSE LOM/I-APA 8.1 DME and hold.</p>	
ATIS <b>120.3</b>	DENVER APP CON <b>132.75 269.3</b>	CENTENNIAL TOWER <b>118.9</b>		GND CON <b>121.8</b>	CLNC DEL <b>128.6</b>

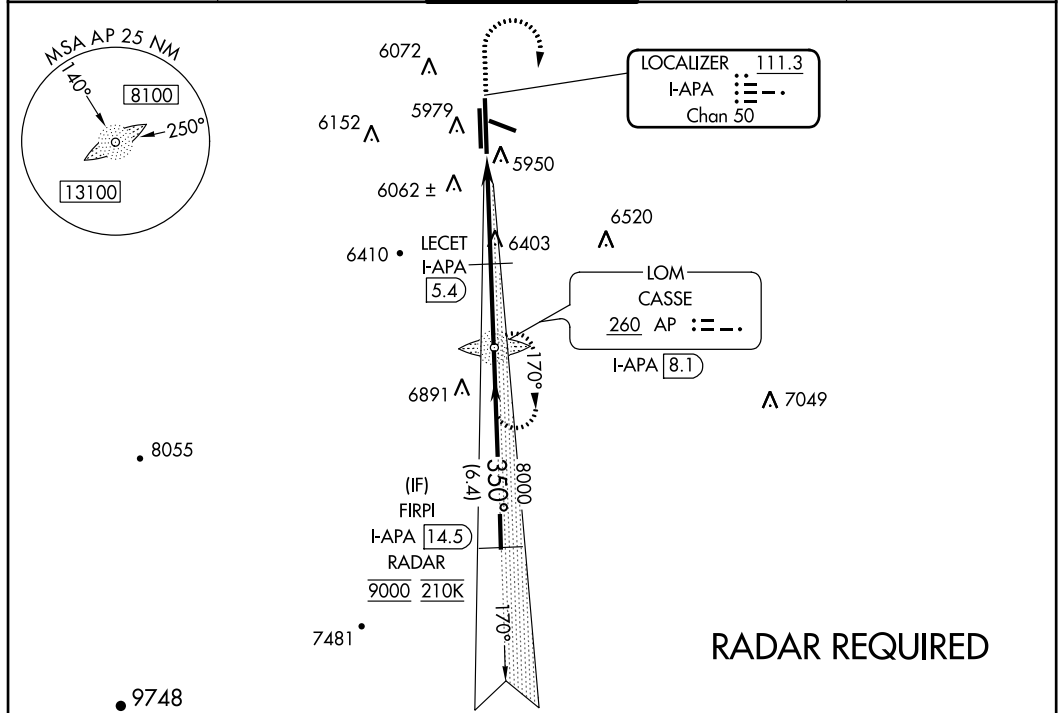

ELEV 5885	THRE 35R 5885 THRE 35L 5869	7400	9000	AP	VGSI and ILS glidepath not coincident (VGSI Angle 3.00/TCH 45).	FIRPI I-APA 14.5 RADAR																																								
<p>MIRL all Rwys REIL Rwys 17R, 28, and 35L</p>		<p>*LOC only</p>		<p>*I-APA 4.5</p>		<p>LOM I-APA 8.1</p> <p>LECET I-APA 5.4</p> <p>7977</p> <p>350°</p> <p>9000</p> <p>GS 3.00° TCH 53</p>																																								
<p>TWR 5993</p> <p>17L</p> <p>17R</p> <p>0.9% UP</p> <p>10001 X 100</p> <p>4800 X 75</p> <p>0.6% UP</p> <p>28</p> <p>0.9% DOWN</p> <p>35L</p> <p>35R</p> <p>350° 6.3 NM from FAF</p>		<p>2.7 NM</p> <p>0.9 NM</p> <p>2.7 NM</p> <p>6.4 NM</p>		<table border="1"> <tr> <td>CATEGORY</td> <td>A</td> <td>B</td> <td>C</td> <td>D</td> </tr> <tr> <td>S-ILS 35R</td> <td colspan="4">6085-1/2 200 (200-1/2)</td> </tr> <tr> <td>S-LOC 35R</td> <td>7080-1 1/4 1195 (1200-1 1/4)</td> <td>7080-1 1/2 1195 (1200-1 1/2)</td> <td>7080-3</td> <td>1195 (1200-3)</td> </tr> <tr> <td>SIDESTEP 35L</td> <td>7080-1 1/4 1211 (1200-1 1/4)</td> <td>7080-1 1/2 1211 (1200-1 1/2)</td> <td>7080-3</td> <td>1211 (1200-3)</td> </tr> <tr> <td>CIRCLING 35R</td> <td>7080-1 1/4 1195 (1200-1 1/4)</td> <td>7080-1 1/2 1195 (1200-1 1/2)</td> <td>7080-3</td> <td>1195 (1200-3)</td> </tr> <tr> <td colspan="5" style="text-align: center;">LECET FIX MINIMUMS (DME REQUIRED)</td> </tr> <tr> <td>S-LOC 35R</td> <td>6800-3/4</td> <td>915 (1000-3/4)</td> <td>6800-2</td> <td>915 (1000-2)</td> </tr> <tr> <td>CIRCLING 35R</td> <td>6800-1 1/4</td> <td>915 (1000-1 1/4)</td> <td>6800-2 3/4 915 (1000-2 3/4)</td> <td>6800-3 915 (1000-3)</td> </tr> </table>			CATEGORY	A	B	C	D	S-ILS 35R	6085-1/2 200 (200-1/2)				S-LOC 35R	7080-1 1/4 1195 (1200-1 1/4)	7080-1 1/2 1195 (1200-1 1/2)	7080-3	1195 (1200-3)	SIDESTEP 35L	7080-1 1/4 1211 (1200-1 1/4)	7080-1 1/2 1211 (1200-1 1/2)	7080-3	1211 (1200-3)	CIRCLING 35R	7080-1 1/4 1195 (1200-1 1/4)	7080-1 1/2 1195 (1200-1 1/2)	7080-3	1195 (1200-3)	LECET FIX MINIMUMS (DME REQUIRED)					S-LOC 35R	6800-3/4	915 (1000-3/4)	6800-2	915 (1000-2)	CIRCLING 35R	6800-1 1/4	915 (1000-1 1/4)	6800-2 3/4 915 (1000-2 3/4)	6800-3 915 (1000-3)
CATEGORY	A	B	C	D																																										
S-ILS 35R	6085-1/2 200 (200-1/2)																																													
S-LOC 35R	7080-1 1/4 1195 (1200-1 1/4)	7080-1 1/2 1195 (1200-1 1/2)	7080-3	1195 (1200-3)																																										
SIDESTEP 35L	7080-1 1/4 1211 (1200-1 1/4)	7080-1 1/2 1211 (1200-1 1/2)	7080-3	1211 (1200-3)																																										
CIRCLING 35R	7080-1 1/4 1195 (1200-1 1/4)	7080-1 1/2 1195 (1200-1 1/2)	7080-3	1195 (1200-3)																																										
LECET FIX MINIMUMS (DME REQUIRED)																																														
S-LOC 35R	6800-3/4	915 (1000-3/4)	6800-2	915 (1000-2)																																										
CIRCLING 35R	6800-1 1/4	915 (1000-1 1/4)	6800-2 3/4 915 (1000-2 3/4)	6800-3 915 (1000-3)																																										
FAF to MAP 6.3 NM																																														
Knots	60	90	120	150	180																																									
Min:Sec	6:18	4:12	3:09	2:31	2:06																																									

DENVER, COLORADO

Amdt 9A 07FEB13

39°34'N-104°51'W

DENVER/ CENTENNIAL (APA)  
**ILS or LOC RWY 35R**

FIGURE 227.—ILS or LOC RWY 35R (APA).

ATLANTA, GEORGIA

AL-5932 (FAA)

13290

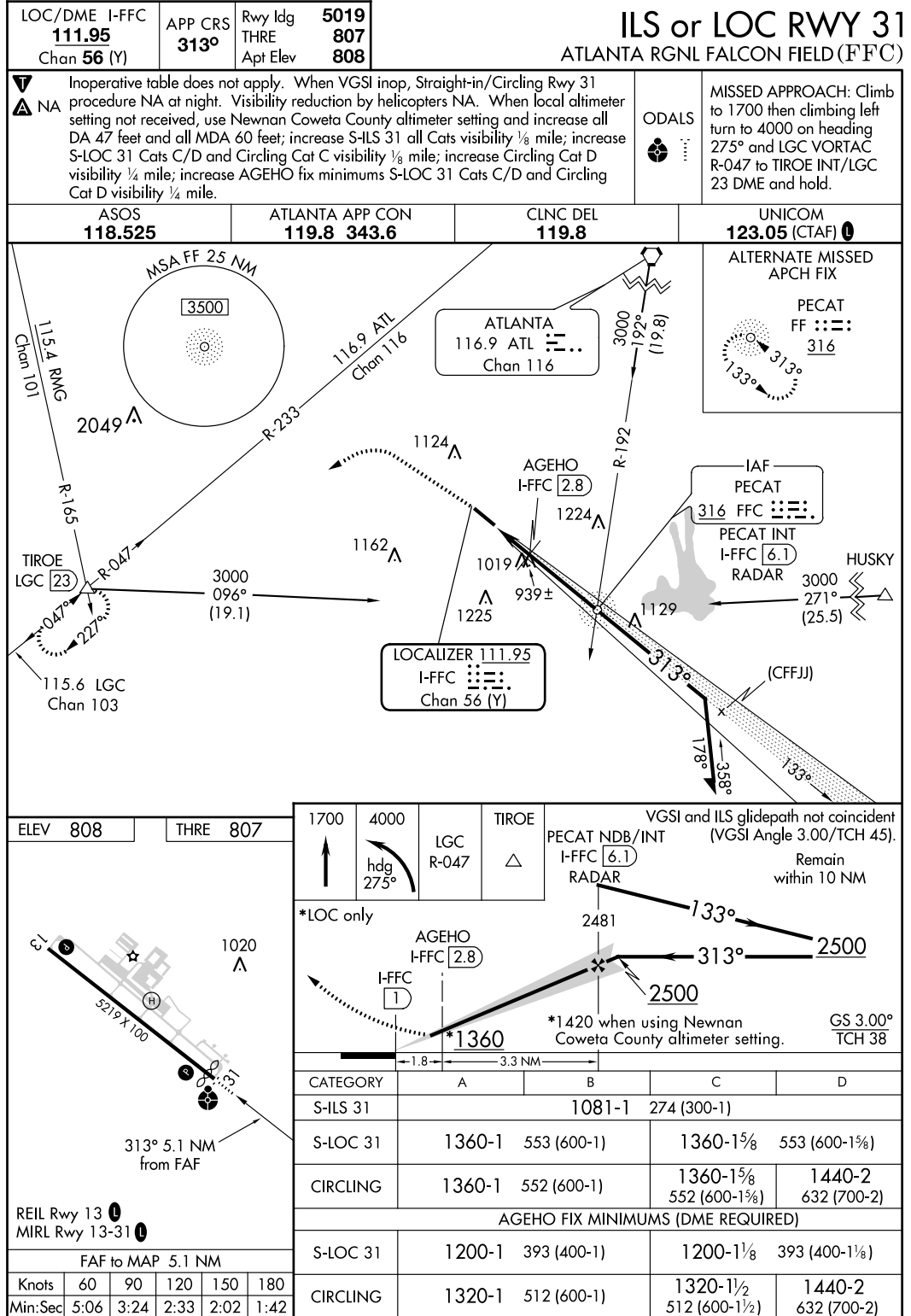

ATLANTA, GEORGIA

Amdt 2 15NOV12

33°21'N-84°34'W

ATLANTA RGNL FALCON FIELD (F'F'C)

ILS or LOC RWY 31

FIGURE 228.—ILS or LOC RWY 31 (FFC).

ATLANTA, GEORGIA

AL-5932 (FAA)

12320

WAAS CH <b>61006</b> <b>W13A</b>	APP CRS <b>133°</b>	Rwy Idg THRE Apt Elev	<b>5219</b> <b>797</b> <b>808</b>
--	------------------------	-----------------------------	---

**RNAV (GPS) RWY 13**  
ATLANTA RGNL FALCON FIELD (FFC)

▼ For uncompensated Baro-VNAV systems, LNAV/VNAV NA below -9°C (16°F) or above 54°C (130°F). DME/DME RNP-0.3 NA. When local altimeter setting not received, use Newnan Coweta County altimeter setting and increase all DA 47 feet and all MDA 60 feet; increase LNAV/VNAV all Cats, LNAV Cats C/D, and Circling Cat D visibility ¼ mile; increase Circling Cat C visibility ⅛ mile. Baro-VNAV and VDP NA when using Newnan Coweta County altimeter setting.

MISSED APPROACH: Climb to 3000 direct INOGE and hold.

ASOS <b>118.525</b>	ATLANTA APP CON <b>119.8 343.6</b>	CLNC DEL <b>119.8</b>	UNICOM <b>123.05 (CTAF) 1</b>
------------------------	---------------------------------------	--------------------------	----------------------------------

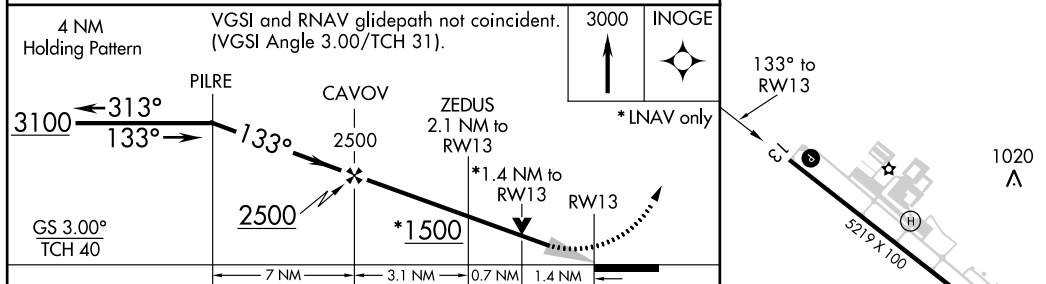
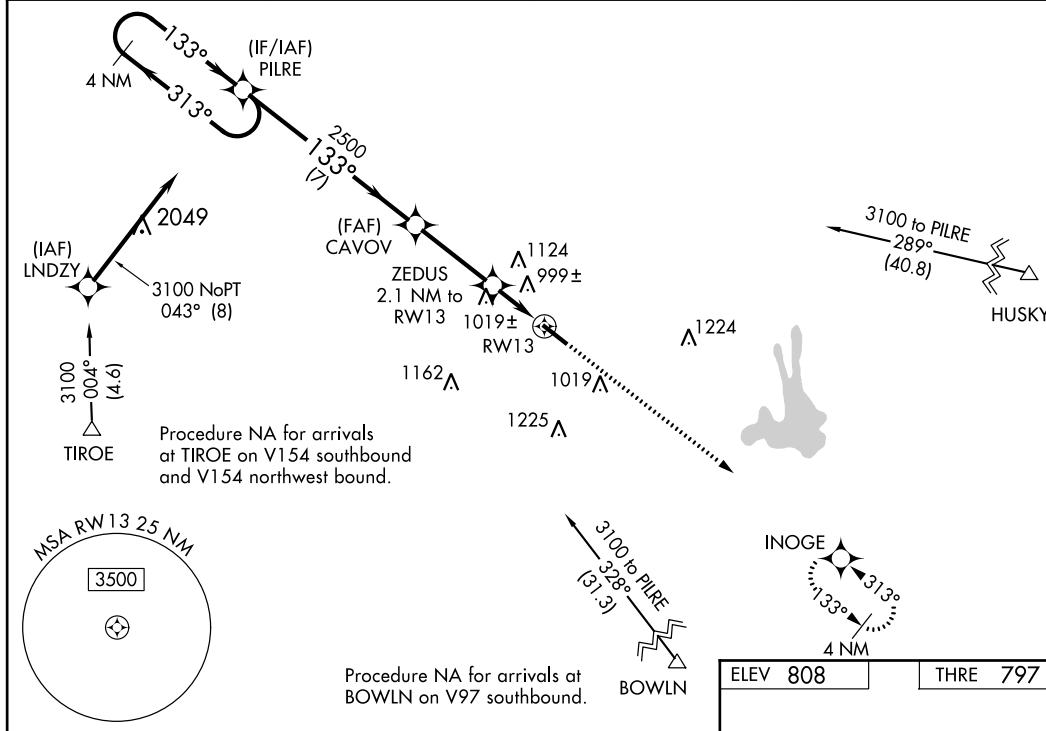

CATEGORY	A	B	C	D
LPV DA	997-¾		200 (200-¾)	
LNAV/VNAV DA	1311-1¾		514 (600-1¾)	
LNAV MDA	1280-1	483 (500-1)	1280-1⅜	483 (500-1⅜)
CIRCLING	1320-1	512 (600-1)	1320-1½	1440-2 632 (700-2)

REIL Rwy 13 1  
MIRL Rwy 13-31 1

ATLANTA, GEORGIA  
Amdt 2 15NOV12

33°21'N-84°34'W

ATLANTA RGNL FALCON FIELD (FFC)  
**RNAV (GPS) RWY 13**

FIGURE 229.—RNAV (GPS) RWY 13 (FFC).



BALDWIN, MICHIGAN

AL-6787 (FAA)

VOR/DME HIC <b>117.6</b> Chan <b>123</b>	APP CRS <b>345°</b>	Rwy Idg TDZE Apt Elev <b>N/A</b> <b>N/A</b> <b>828</b>
--	------------------------	---

VOR/DME or GPS-A  
BALDWIN MUNI (7D3)

<p>▼ Use Manistee altimeter setting. ▲ NA Procedure not authorized at night.</p>	<p>MISSED APPROACH: Climb to 2600, then left turn via the HIC VOR/DME R-345 to HOPPR/14 DME and hold.</p>
<p>MINNEAPOLIS CENTER <b>120.85 322.35</b></p>	<p>CTAF <b>122.9</b></p>

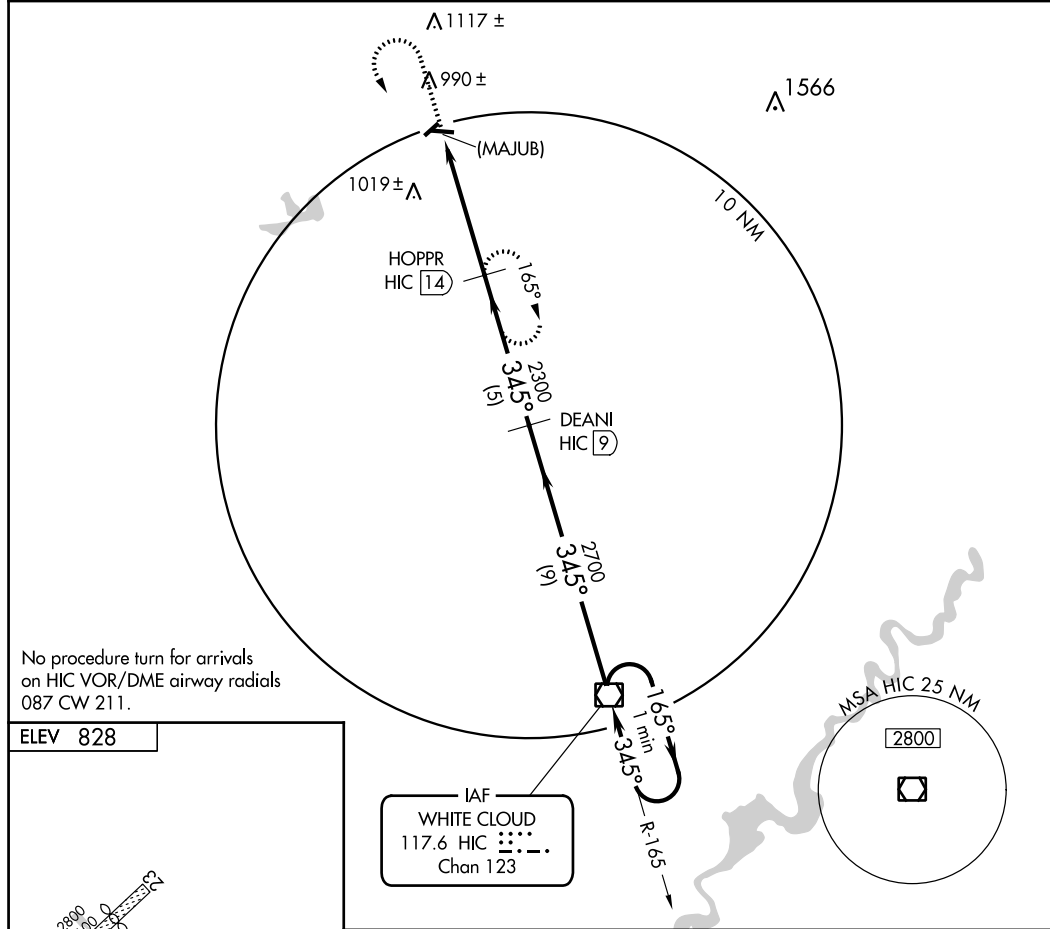

No procedure turn for arrivals on HIC VOR/DME airway radials 087 CW 211.

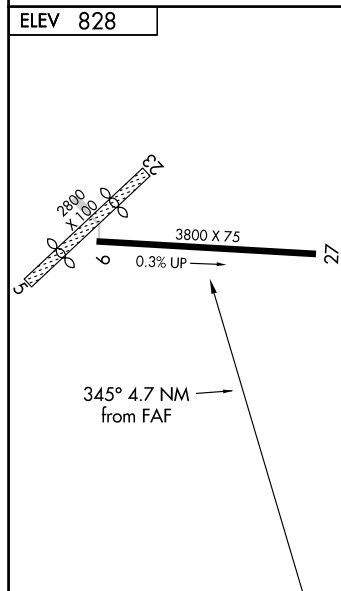

2600	HOPPR INT	VOR/DME		
HIC R-345		DEANI HIC 9	One Minute Holding Pattern	
(MAJUB) HIC 18.7	HOPPR HIC 14	2700	165° →	2700
		2300	← 345°	
	4.7 NM	5 NM	9 NM	
CATEGORY	A	B	C	D
CIRCLING	1400-1	572 (600-1)	1400-1½ 572 (600-1½)	NA

BALDWIN, MICHIGAN  
Amdt 1 10322

43°53'N - 85°51'W

BALDWIN MUNI (7D3)  
VOR/DME or GPS-A

FIGURE 230.—VOR/DME or GPS-A (7D3).

130

MICHIGAN

**BALDWIN MUNI** (7D3) 2 S UTC-5(-4DT) N43°52.53' W85°50.53'

CHICAGO

828 TPA—1828(1000) NOTAM FILE LAN

L-281

RWY 09-27: H3800X75 (ASPH) S-10 0.3% up E

IAP

RWY 09: Trees.

RWY 27: Trees.

RWY 05-23: 2800X100 (TURF)

RWY 05: Thld dsplcd 800'. Trees.

RWY 23: Thld dsplcd 800'. Trees.

**AIRPORT REMARKS:** Unattended. Deer on and invof arpt. Arpt CLOSED Nov thru Apr; no snow removal. Arpt manager cell 231-250-2551. Rwy 09-27 sfc considerable pavement cracking with vegetation growing through cracks. Rwy 05-23 and dsplcd thlds marked with 3' yellow cones.

**COMMUNICATIONS:** CTAF 122.9

Ⓜ MINNEAPOLIS CENTER APP/DEP CON 120.85

**RADIO AIDS TO NAVIGATION:** NOTAM FILE LAN.

WHITE CLOUD (L) VOR/DME 117.6 HIC Chan 123 N43°34.49'

W85°42.97' 344° 18.9 NM to fld. 920/1W.

VOR/DME unusable:

020°-090° byd 30 NM blo 3,000'

DME portion unusable:

270°-290° byd 35 NM blo 3,000'

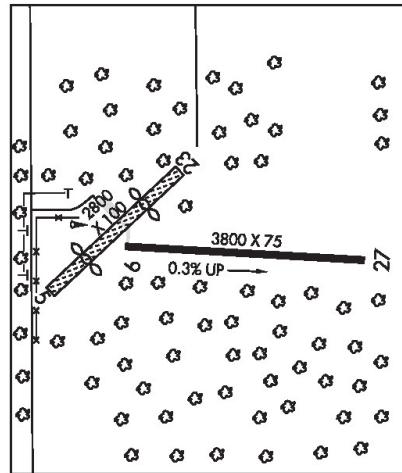

**BANGU** N45°00.88' W84°48.49' NOTAM FILE GLR.

LAKE HURON

NDB (LOM) 375 GL 097° 4.5 NM to Gaylord Rgnl. Unmonitored.

**BANNISTER**

**SHADY LAWN FLD** (4M4) 2 E UTC-5(-4DT) N43°07.72' W84°22.88'

CHICAGO

680 TPA—1680(1000) NOTAM FILE LAN

RWY 09-27: 1850X50 (TURF) LIRL

RWY 09: Bldg.

RWY 27: Trees.

**AIRPORT REMARKS:** Attended irregularly. Ultralight and AG activity on and invof arpt. Deer and birds on and invof arpt. Crops adjacent to rwy during summer months. NSTD LIRL color and configuration, by prior arrangement. Rwy 09 and Rwy 27 marked by 3' yellow cones.

**COMMUNICATIONS:** CTAF 122.9

**BARAGA** (2P4) 4 W UTC-5(-4DT) N46°47.10' W88°34.67'

GREEN BAY

845 TPA—1845(1000) NOTAM FILE GRB

RWY 09-27: 2200X100 (TURF)

RWY 09: Trees.

RWY 27: Trees.

**AIRPORT REMARKS:** Unattended. Arpt CLOSED Nov-Apr except to ski equipped acft. 25' p-line 850' from thld Rwy 27. Deer and birds on and invof arpt.

**COMMUNICATIONS:** CTAF 122.9

**BATH**

**UNIVERSITY AIRPARK** (41G) 2 NW UTC-5(-4DT) N42°50.42' W84°28.75'

DETROIT

856 B S2 NOTAM FILE LAN

RWY 08-26: 1988X100 (TURF) LIRL

RWY 08: Trees.

RWY 26: Tree.

**AIRPORT REMARKS:** Attended irregularly. Rwy 08-26 occasionally soft/wet areas E end during spring thaw and after heavy rain. ACTIVATE LIRL Rwy 08-26 and NSTD rotating bcn—122.85. NSTD flashing strobe and alternating white/red bcn. Rwy 08-26 marked with 3' yellow cones.

**COMMUNICATIONS:** CTAF 122.9

**BATOL** N42°21.72' W85°11.07' NOTAM FILE BTL.

CHICAGO

NDB (MHW/LOM) 272 BT 225° 4.4 NM to W K Kellogg.

L-281

FIGURE 231.—Excerpt from Chart Supplement.

DUNCAN, OKLAHOMA

AL-5140 (FAA)

10266

LOC I-DUC	APP CRS	Rwy Idg	6326
111.5	352°	TDZE	1094
		Apt Elev	1114

# LOC RWY 35

DUNCAN/ HALLIBURTON FIELD (DUC)

▼ Visibility reduction by helicopters NA. When local altimeter setting not received, use Henry Post AAF (Fort Sill) altimeter setting and increase all MDA 80 feet and visibility S-35 Cat C/D ¼ mile and Circling Cat D ¼ mile.

▲ NA MISSED APPROACH: Climb to 2000 then climbing right turn to 3000 direct DUC VOR/DME and hold.

AWOS-3	FORT SILL APP CON	CLNC DEL	UNICOM
119.075	118.6 290.375	118.4	122.8 (CTAF) 0

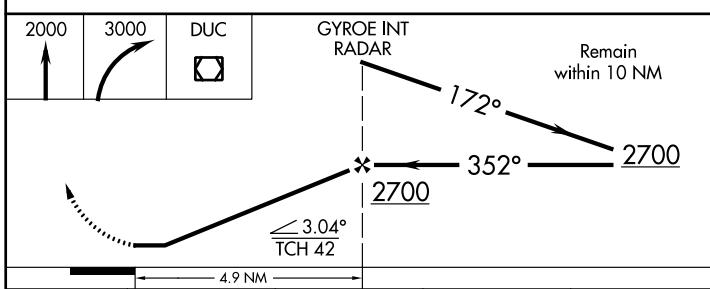
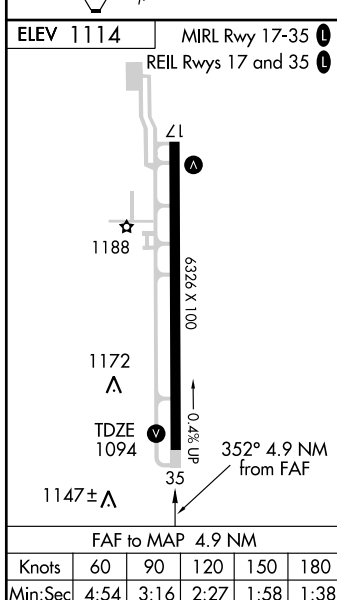
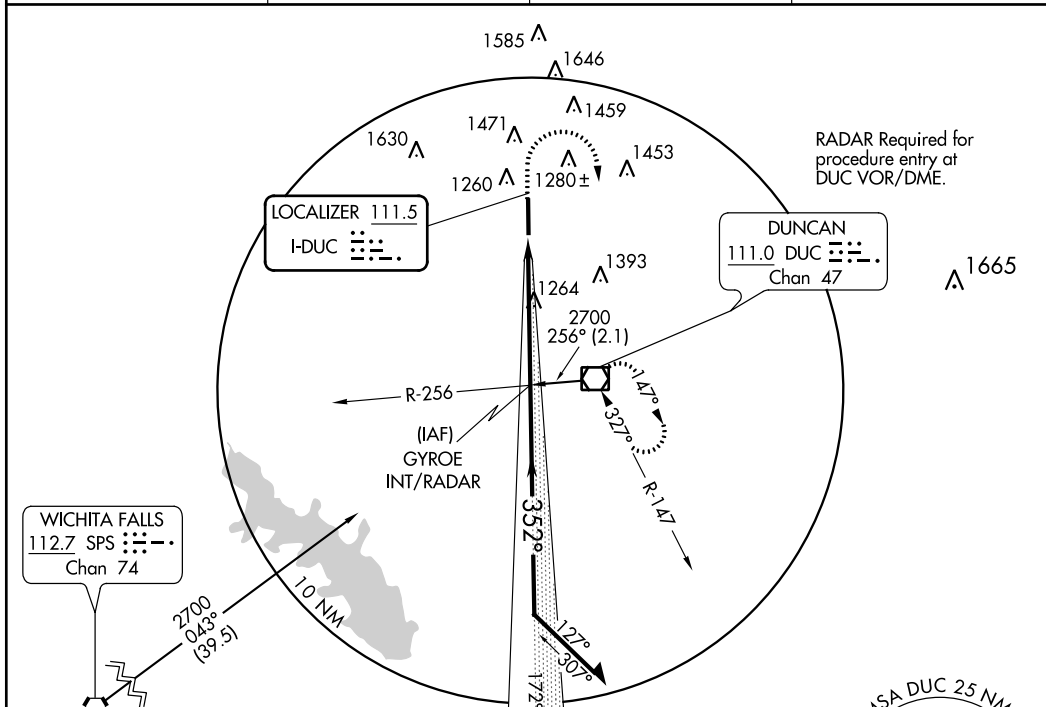

CATEGORY	A	B	C	D
S-35	1520-1	426 (500-1)	1520-1¼	426 (500-1¼)
CIRCLING	1560-1	1580-1	1580-1½	1840-2¼
	446 (500-1)	466 (500-1)	466 (500-1½)	726 (800-2¼)

DUNCAN, OKLAHOMA  
Amdt 5 23SEP10

34°28'N - 97°58'W

DUNCAN/ HALLIBURTON FIELD (DUC)

# LOC RWY 35

FIGURE 232.—LOC RWY 35 (DUC).

DUNCAN, OKLAHOMA

AL-5140 (FAA)

10266

WAAS CH <b>93619</b> <b>W17A</b>	APP CRS <b>172°</b>	Rwy Idg TDZE Apt Elev	<b>6326</b> <b>1114</b> <b>1114</b>
--	------------------------	-----------------------------	---

# RNAV (GPS) RWY 17

DUNCAN/ HALLIBURTON FIELD (DUC)

Baro-VNAV NA when using Henry Post AAF, (Fort Sill) altimeter setting. For uncompensated Baro-VNAV systems, LNAV/VNAV NA below -17°C (2°F) or above 46°C (114°F). DME/DME RNP-0.3 NA. Visibility reduction by helicopters NA. When local altimeter setting not received, use Henry Post AAF, (Fort Sill) altimeter setting and increase all DA 67 feet and LPV and LNAV/VNAV visibility ¼ mile all Cats, increase all MDA 80 feet and LNAV Cat B visibility ¼ mile, Cat C and D visibility ½ mile, increase Circling Cat B and D visibility ¼ mile and Cat C visibility ½ mile. VDP NA with Henry Post AAF, (Fort Sill) altimeter setting.

MISSED APPROACH: Climb to 3000 direct JEGMO and on track 140° to DUC VOR/DME and hold.

AWOS-3 <b>119.075</b>	FORT SILL APP CON <b>118.6 290.375</b>	CLNC DEL <b>118.4</b>	UNICOM <b>122.8 (CTAF)</b>
--------------------------	---	--------------------------	-------------------------------

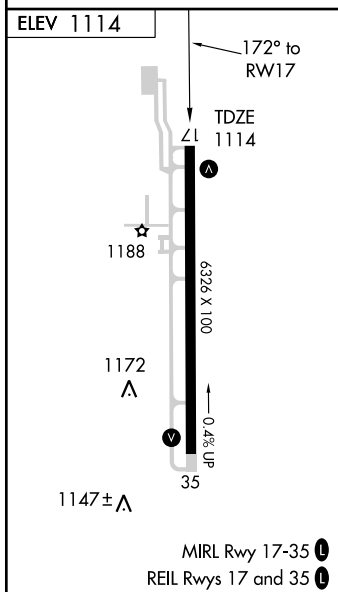
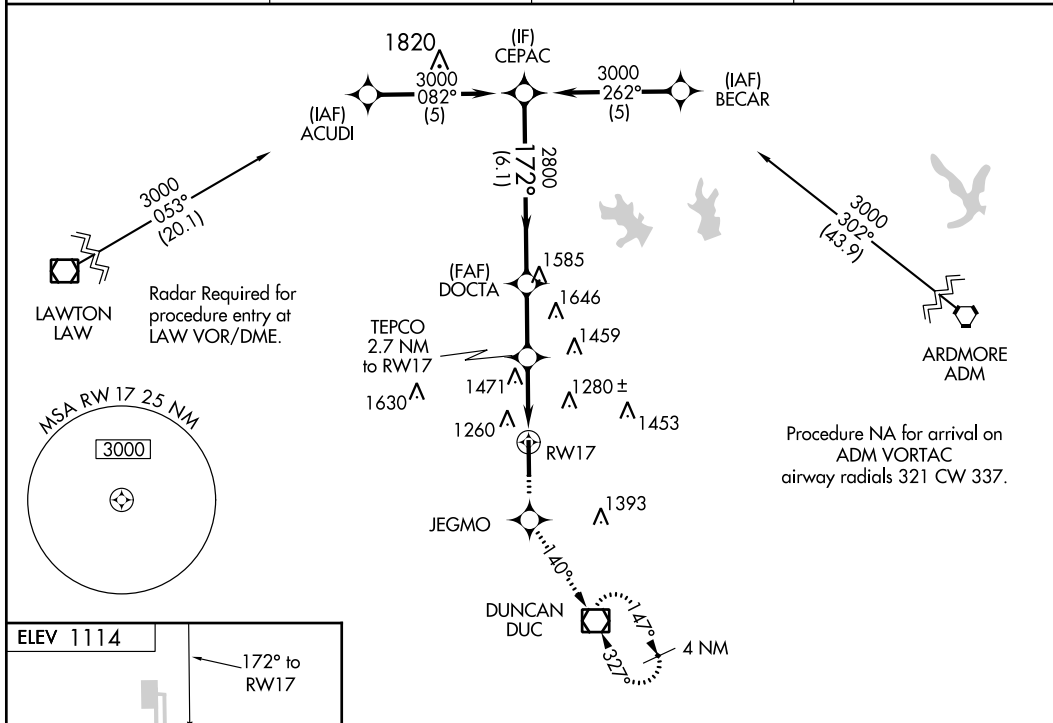

3000	JEGMO	tr 140°	DUC	Procedure Turn NA
* LNAV only		TEPCO 2.7 NM to RWY 17	DOCTA 2800	CEPAC 3000
* 1.9 NM to RWY 17		2020*	172°	GS 3.00° TCH 53
1.9		0.8	2.4 NM	6.1 NM
CATEGORY	A	B	C	D
LPV DA	1390-1 276 (300-1)			
LNAV/VNAV DA	1903-2 ¾ 789 (800-2 ¾)			
LNAV MDA	1780-1	666 (700-1)	1780-1 ¾ 666 (700-1 ¾)	1780-2 666 (700-2)
CIRCLING	1780-1	666 (700-1)	1780-1 ¾ 666 (700-1 ¾)	1840-2 ¼ 726 (800-2 ¼)

DUNCAN, OKLAHOMA  
Amdt 1 23SEP10

34°28'N - 97°58'W

# RNAV (GPS) RWY 17

FIGURE 233.—RNAV (GPS) RWY 17 (DUC).

LINCOLN, NEBRASKA

AL-232 (FAA)

13066

LOC I-OCZ <b>111.1</b>	APP CRS <b>174°</b>	Rwy Idg THRE Apt Elev	<b>12901</b> <b>1195</b> <b>1219</b>	<b>ILS or LOC RWY 18</b> LINCOLN (LNK)
<p><b>▽</b> *RVR 1800 authorized with the use of FD or AP or HUD to DA. When local altimeter setting not received use Beatrice altimeter setting and increase all DA 91 feet and all MDA 100 feet, increase S-LOC 18 Cat C/D/E visibility to 1½, Circling Cat C visibility to 2 and Cat D visibility to 2¼; increase ROROC fix minimums S-LOC 18 Cat C/D/E visibility to 1¾ Circling Cat C visibility to 1¾ and Cat D visibility to 2¼. For inoperative MALSRS, increase S-ILS 18 Cat E visibility to RVR 4000, S-LOC 18 Cat E visibility to 1¾, and ROROC fix minimums S-LOC 18 Cat E visibility to 1½. For inoperative MALSRS when using Beatrice altimeter setting, increase S-ILS 18 all Cats visibility to RVR 4500, S-LOC 18 Cat E visibility to 2, and ROROC fix minimums S-LOC 18 Cat C/D/E visibility to 1¾.</p>				

ATIS <b>118.05 290.9</b>	LINCOLN APP CON <b>124.0 270.3</b>	LINCOLN TOWER★ <b>118.5(CTAF) 253.5</b>	GND CON <b>121.9 275.8</b>	CLNC DEL <b>120.7 225.4</b>	UNICOM <b>122.95</b>
-----------------------------	---------------------------------------	--	-------------------------------	--------------------------------	-------------------------

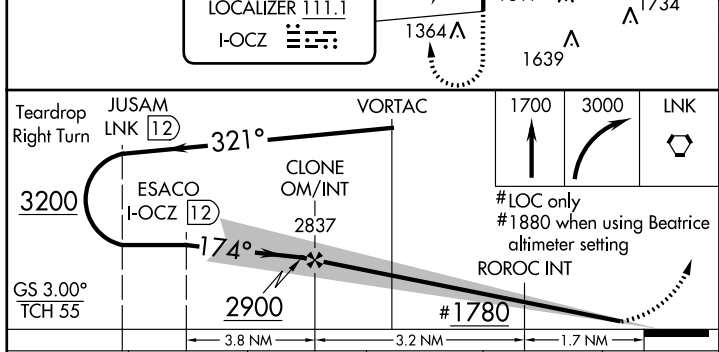
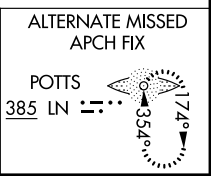
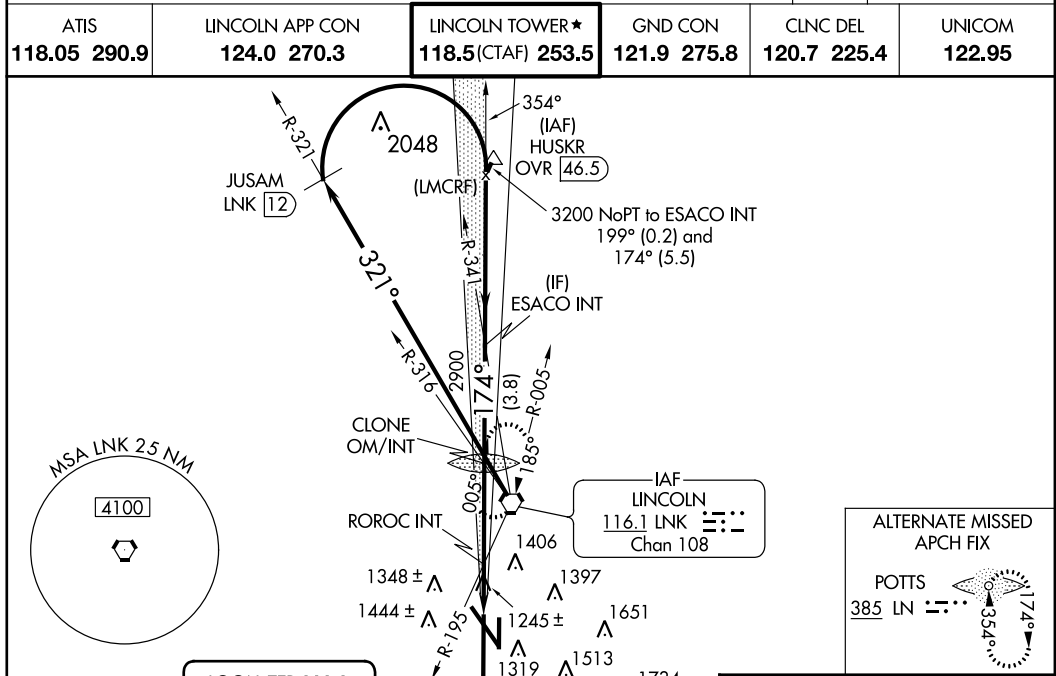

ELEV 1219	THRE 1195
174° 4.9 NM from FAF	
HIRL Rwy 18-36 and Rwy 17-35 MIRL Rwy 14-32 REIL Rwy 14 and 17	
FAF to MAP 4.9 NM	
Knots	60 90 120 150 180
Min:Sec	4:54 3:16 2:27 1:58 1:38

CATEGORY	A	B	C	D	E
S-ILS 18	*1395/24 200 (200-½)				
S-LOC 18	1780/24	585 (600-½)	1780-1¼	585 (600-1¼)	
CIRCLING	1780-1	561 (600-1)	1780-1¾	1820-2	2040-3
			561 (600-1¾)	601 (700-2)	821 (900-3)
ROROC FIX MINIMUMS (DUAL VOR RECEIVERS REQUIRED)					
S-LOC 18	1720/24	525 (600-½)	1720/55	525 (600-1¼)	
CIRCLING	1720-1	1760-1	1760-1½	1820-2	2040-3
	501 (600-1)	541 (600-1)	541 (600-1½)	601 (700-2)	821 (900-3)

LINCOLN, NEBRASKA  
Amdt 7 05APR12

40°51'N-96°46'W

LINCOLN (LNK)  
ILS or LOC RWY 18

FIGURE 234.—ILS or LOC RWY 18 (LNK).

LINCOLN, NEBRASKA

AL-232 (FAA)

13066

WAAS CH <b>69328</b> <b>W32A</b>	APP CRS <b>319°</b>	Rwy Idg THRE Apt Elev	<b>7816</b> <b>1179</b> <b>1219</b>
--	------------------------	-----------------------------	---

# RNAV (GPS) RWY 32

LINCOLN (LNK)

**▼** Baro-VNAV NA when using Beatrice altimeter setting. For uncompensated Baro-VNAV systems, LNAV/VNAV NA below -25°C (-13°F) or above 54°C (130°F). DME/DME RNP-0.3 NA.  
**▲** VDP NA with Beatrice altimeter setting. When local altimeter setting not received, use Beatrice altimeter setting and increase all DA 91 feet and all MDA 100 feet, increase LPV all Cats visibility 1/8 mile, increase LNAV/VNAV all Cats visibility 3/8 mile, increase LNAV Cats C/D and Circling Cats C/D visibility 1/4 mile. Helicopter visibility reduction below 3/4 SM NA.

MISSED APPROACH:  
Climb to 3200 direct ZUBTO and hold.

ATIS <b>118.05 290.9</b>	LINCOLN APP CON <b>124.0 270.3</b>	LINCOLN TOWER* <b>118.5(CTAF) 253.5</b>	GND CON <b>121.9 275.8</b>	CLNC DEL <b>120.7 225.4</b>	UNICOM <b>122.95</b>
-----------------------------	---------------------------------------	--	-------------------------------	--------------------------------	-------------------------

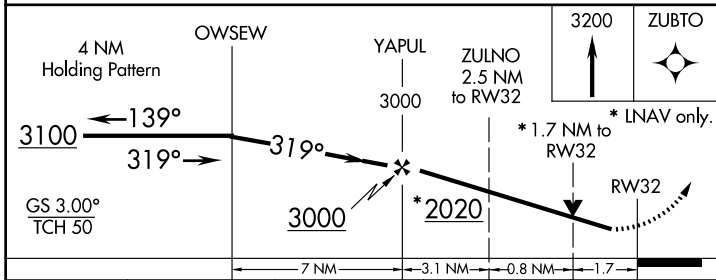
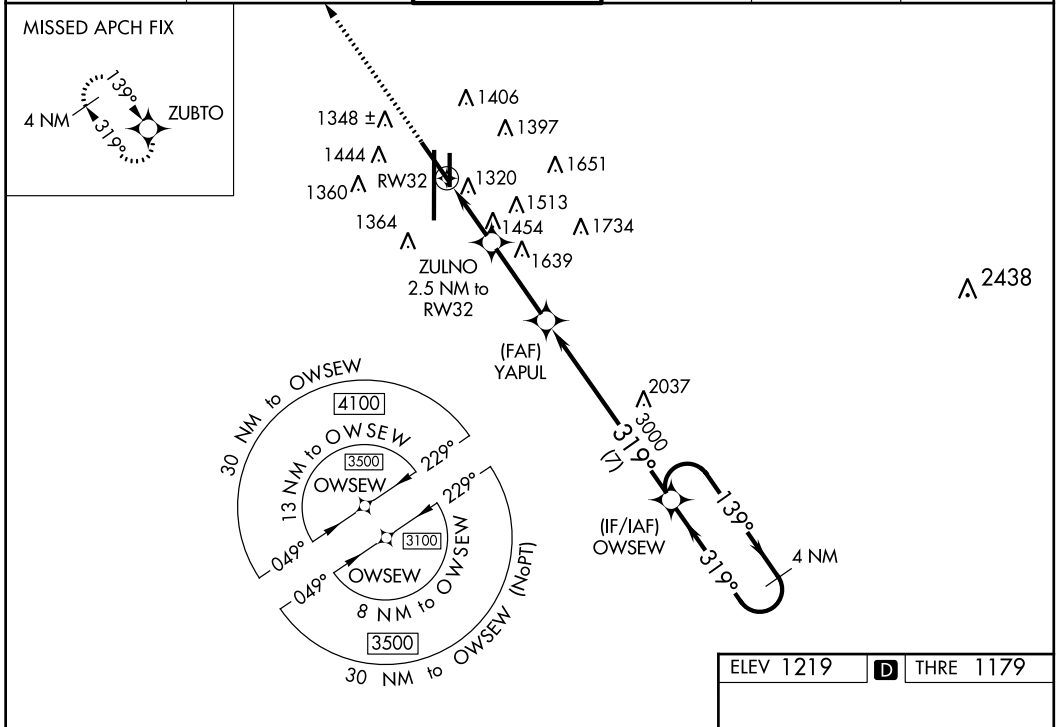

CATEGORY	A	B	C	D
LPV DA	1429-1 250 (300-1)			
LNAV/VNAV DA	1563-1 1/4 384 (400-1 1/4)			
LNAV MDA	1760-1 581 (600-1)		1760-1 3/4 581 (600-1 3/4)	
CIRCLING	1760-1 541 (600-1)		1760-1 3/4 541 (600-1 3/4) 1820-2 601 (700-2)	

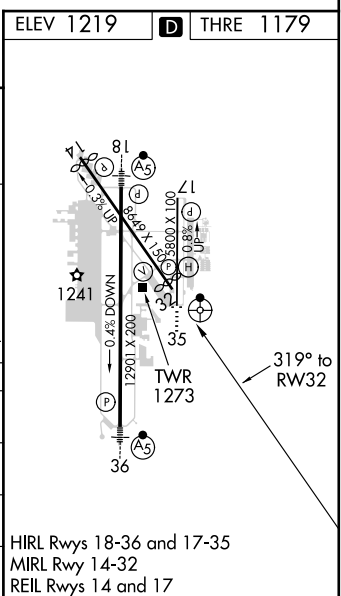

LINCOLN, NEBRASKA  
Orig 07MAR13

40°51'N-96°46'W

# LINCOLN (LNK) RNAV (GPS) RWY 32

FIGURE 235.—RNAV (GPS) RWY 32 (LNK).

DOTHAN, ALABAMA

AL-123 (FAA)

13178

LOC I-DHN <b>108.3</b>	APP CRS <b>318°</b>	Rwy Idg THRE Apt Elev	<b>8496</b> <b>382</b> <b>401</b>	<b>ILS or LOC RWY 32</b> DOTHAN RGNL (DHN)
<p><b>V</b> **RVR 1800 authorized with use of FD or AP or HUD to DA. <b>A</b> For inoperative MALSR, increase S-LOC 32 Cat C/D visibility to 2½ miles.</p>			<p>MALSR</p> 	

ATIS <b>135.72</b>	CAIRNS APP CON* <b>125.4 327.125</b>	DOTHAN TOWER * <b>118.4 (CTAF) 257.6</b>	GND CON <b>121.7 348.6</b>	UNICOM <b>122.95</b>
-----------------------	---	---	-------------------------------	-------------------------

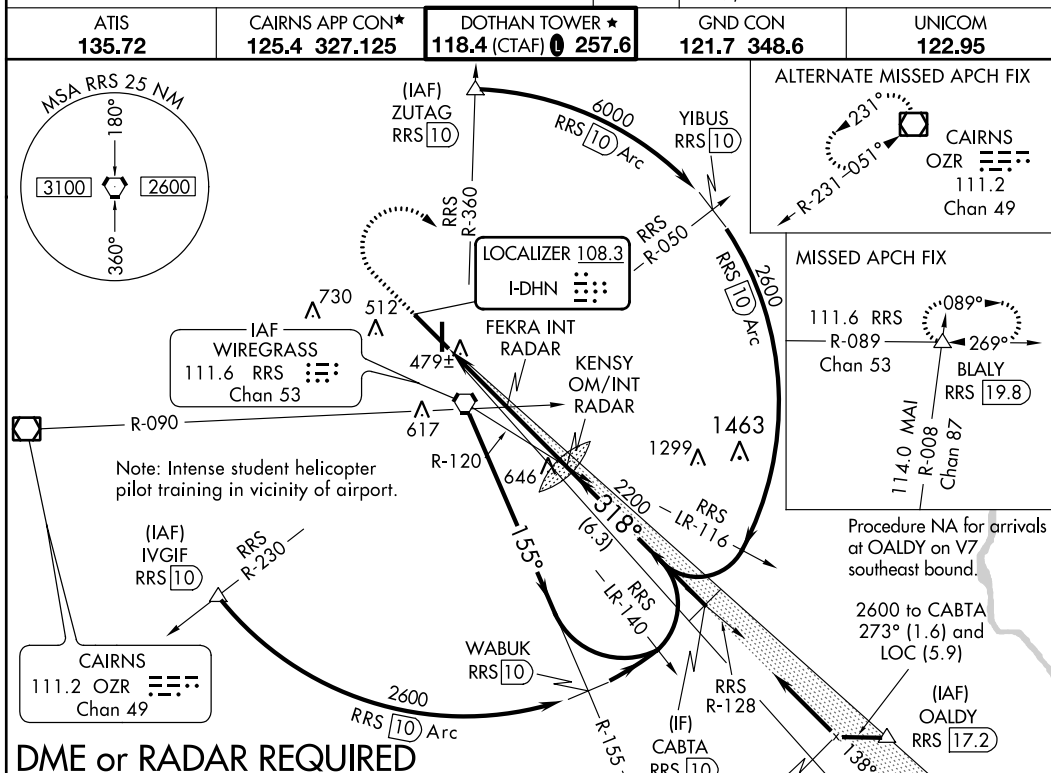

**DME or RADAR REQUIRED**

ELEV 401	<b>D</b>	THRE 382	<p>1000</p> <p>3000</p> <p>BLALY</p> <p>VORTAC</p> <p>Teardrop left turn within 10 NM of RRS VORTAC.</p> <p>* LOC only</p> <p>FEKRA INT RADAR</p> <p>KENSY OM/INT RADAR</p> <p>I-DHN 318°</p> <p>2200</p> <p>2200</p> <p>GS 3.00°</p> <p>TCH 57</p>																																											
			<p>WABUK RRS 10</p> <p>2.7 NM</p> <p>2.7 NM</p>																																											
<p>REIL Rwy 18</p> <p>REIL Rwy 14</p> <p>HIRL Rwy 18-36</p> <p>HIRL Rwy 14-32</p> <p>FAF to MAP 5.4 NM</p>			<table border="1"> <tr> <th>CATEGORY</th> <th>A</th> <th>B</th> <th>C</th> <th>D</th> </tr> <tr> <td>S-ILS 32</td> <td colspan="4">**582/24 200 (200-½)</td> </tr> <tr> <td>S-LOC 32</td> <td>1220/24 838 (900-½)</td> <td>1220/40 838 (900-¾)</td> <td>1220-1⅞</td> <td>838 (900-1⅞)</td> </tr> <tr> <td>CIRCLING</td> <td>1220-1¼</td> <td>819 (900-1¼)</td> <td>1220-2½</td> <td>819 (900-2¾)</td> </tr> <tr> <td colspan="5">FEKRA FIX MINIMUMS (DUAL VOR RECEIVERS OR RADAR REQUIRED)</td> </tr> <tr> <td>S-LOC 32</td> <td>820/24</td> <td>438 (500-½)</td> <td>820/40</td> <td>438 (500-¾)</td> </tr> <tr> <td>CIRCLING</td> <td>860-1</td> <td>459 (500-1)</td> <td>860-1½</td> <td>459 (500-1½)</td> </tr> <tr> <td></td> <td></td> <td></td> <td>960-2</td> <td>559 (600-2)</td> </tr> </table>				CATEGORY	A	B	C	D	S-ILS 32	**582/24 200 (200-½)				S-LOC 32	1220/24 838 (900-½)	1220/40 838 (900-¾)	1220-1⅞	838 (900-1⅞)	CIRCLING	1220-1¼	819 (900-1¼)	1220-2½	819 (900-2¾)	FEKRA FIX MINIMUMS (DUAL VOR RECEIVERS OR RADAR REQUIRED)					S-LOC 32	820/24	438 (500-½)	820/40	438 (500-¾)	CIRCLING	860-1	459 (500-1)	860-1½	459 (500-1½)				960-2	559 (600-2)
CATEGORY	A	B	C	D																																										
S-ILS 32	**582/24 200 (200-½)																																													
S-LOC 32	1220/24 838 (900-½)	1220/40 838 (900-¾)	1220-1⅞	838 (900-1⅞)																																										
CIRCLING	1220-1¼	819 (900-1¼)	1220-2½	819 (900-2¾)																																										
FEKRA FIX MINIMUMS (DUAL VOR RECEIVERS OR RADAR REQUIRED)																																														
S-LOC 32	820/24	438 (500-½)	820/40	438 (500-¾)																																										
CIRCLING	860-1	459 (500-1)	860-1½	459 (500-1½)																																										
			960-2	559 (600-2)																																										
<p>Min:Seq 5:24 3:36 2:42 2:10 1:48</p>			<p>DOTHAN, ALABAMA</p> <p>Amdt 9 26JUL12</p> <p>DOTHAN RGNL (DHN)</p> <p><b>ILS or LOC RWY 32</b></p>																																											

FIGURE 236.—ILS or RWY 32 (DHN).

Appendix 2

LANCASTER, OHIO

AL-6212 (FAA)

WAAS CH <b>97701</b> <b>W10A</b>	APP CRS <b>100°</b>	Rwy Idg TDZE Apt Elev	<b>5004</b> <b>857</b> <b>868</b>
--	------------------------	-----------------------------	---

**RNAV (GPS) RWY 10**  
LANCASTER/FAIRFIELD COUNTY (LHQ)

Baro-VNAV NA when using Rickenbacker Intl altimeter setting. DME/DME RNP-0.3 NA.  
 ▼ For uncompensated Baro-VNAV systems, LNAV/VNAV NA below -16°C (4°F) or above 54°C (130°F). Visibility reduction by helicopters NA. When local altimeter setting not received, use Rickenbacker Intl altimeter setting and increase all DAs 48 feet, and all MDAs 60 feet, and increase LPV, LNAV/VNAV all Cats and Circling Cat C visibility ¼ mile.  
 ▲ MISSED APPROACH: Climb to 2800 direct DIPAC and hold.

ASOS <b>118.375</b>	COLUMBUS APP CON <b>119.15 279.6</b>	CLNC DEL <b>121.65</b>	UNICOM <b>122.725 (CTAF)</b>
------------------------	---	---------------------------	---------------------------------

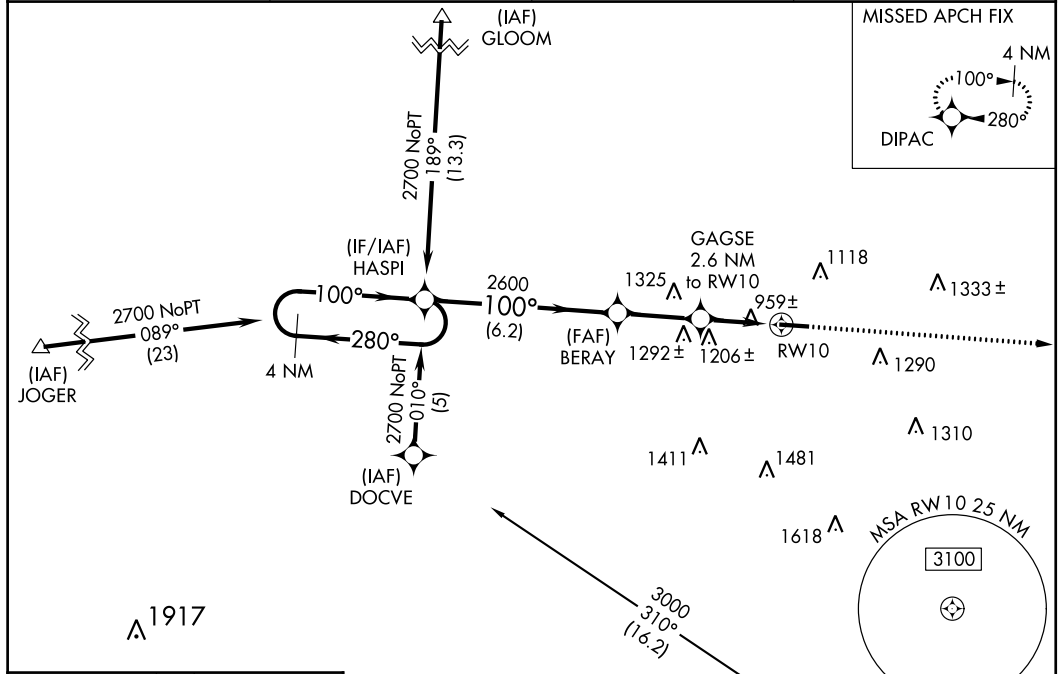

ELEV 868	TDZE 857
----------	----------

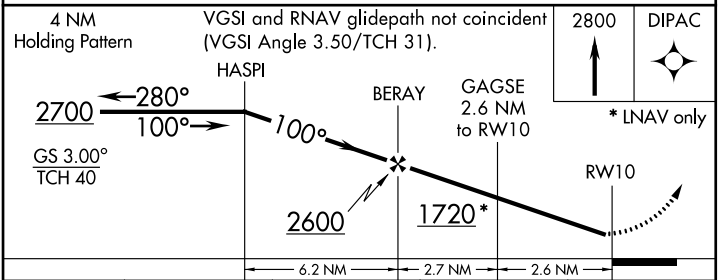
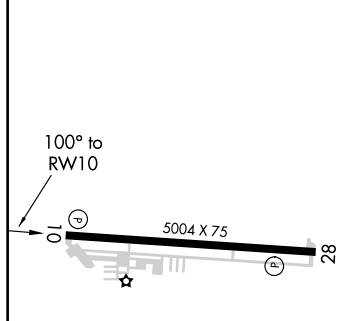

CATEGORY	A	B	C	D
LPV DA	1170-1 313 (400-1)			NA
LNAV/VNAV DA	1291-1½ 434 (500-1½)			NA
LNAV MDA	1460-1 603 (600-1)	1460-1¾ 603 (600-1¾)		NA
CIRCLING	1520-1 652 (700-1)	1540-1 672 (700-1)	1560-2 692 (700-2)	NA

LANCASTER, OHIO  
Orig 13010

39°45'N-82°39'W

LANCASTER/FAIRFIELD COUNTY (LHQ)  
**RNAV (GPS) RWY 10**

FIGURE 237.—RNAV (GPS) RWY 10 (LHQ).



LANCASTER, OHIO

AL-6212 (FAA)

13010

WAAS CH <b>69628</b> <b>W28A</b>	APP CRS <b>280°</b>	Rwy Idg THRE Apt Elev	<b>5004</b> <b>868</b> <b>868</b>
--	------------------------	-----------------------------	---

**RNAV (GPS) RWY 28**  
LANCASTER/FAIRFIELD COUNTY (LHQ)

Baro-VNAV NA when using Rickenbacker Intl altimeter setting. For uncompensated Baro-VNAV systems, LNAV/VNAV NA below -24°C (11°F) or above 54°C (130°F). DME/DME RNP-0.3 NA. Visibility reduction by helicopters NA. VDP NA with Rickenbacker Intl altimeter setting. When local altimeter setting not received, use Rickenbacker Intl altimeter setting and increase all DA 48 feet; increase all MDA 60 feet.

MISSED APPROACH:  
Climb to 2700 direct HASPI and hold.

ASOS <b>118.375</b>	COLUMBUS APP CON <b>119.15 279.6</b>	CLNC DEL <b>121.65</b>	UNICOM <b>122.725 (CTAF)</b>
------------------------	---	---------------------------	---------------------------------

MISSED APCH FIX

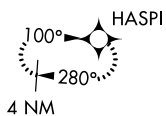

APPLETON APE

Procedure NA for arrivals at APE VORTAC airway radials 090 CW 235.

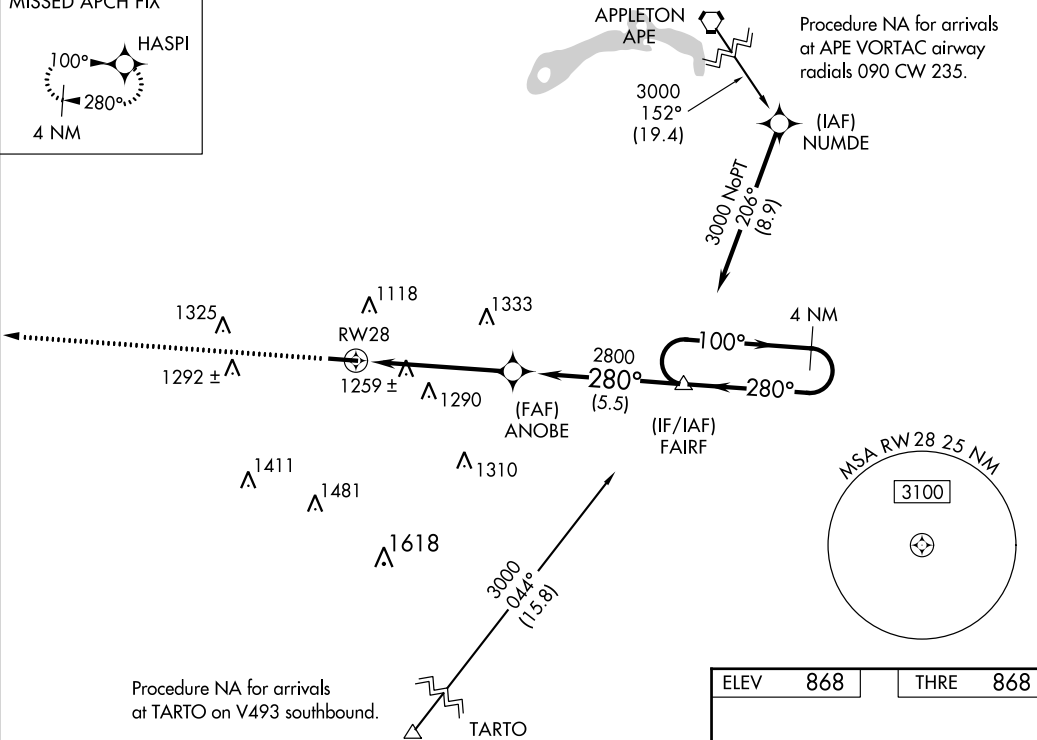

Procedure NA for arrivals at TARTO on V493 southbound.

ELEV	868	THRE	868
------	-----	------	-----

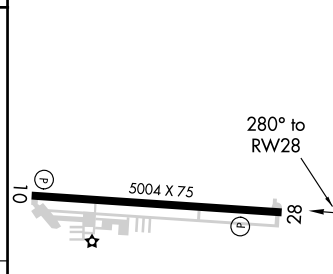
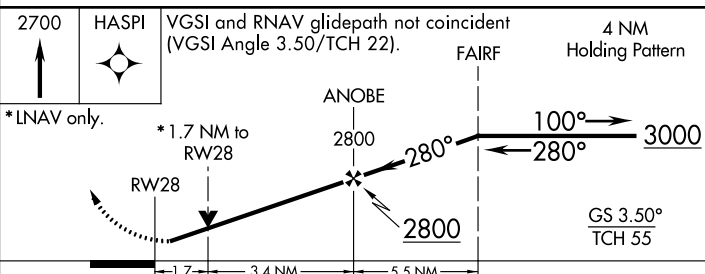

CATEGORY	A	B	C	D
LPV DA	1068-3/4	200 (200-3/4)		NA
LNAV/VNAV DA	1641-2 1/2	773 (800-2 1/2)		NA
LNAV MDA	1520-1	652 (700-1)		NA
CIRCLING	1520-1 652 (700-1)	1540-1 672 (700-1)		NA

REIL Rwy 10 and 28  
HIRL Rwy 10-28

LANCASTER, OHIO  
Amdt 1 15NOV12

39°45'N-82°39'W

LANCASTER/FAIRFIELD COUNTY (LHQ)  
**RNAV (GPS) RWY 28**

FIGURE 238.—RNAV (GPS) RWY 28 (LHQ).

LANCASTER, OHIO

AL-6212 (FAA)

13122

LOC I-LHQ <b>111.9</b>	APP CRS <b>280°</b>	Rwy Idg THRE Apt Elev	<b>5004</b> <b>868</b> <b>868</b>
---------------------------	------------------------	-----------------------------	---

**LOC RWY 28**  
LANCASTER/FAIRFIELD COUNTY (LHQ)

<p><b>ADF required.</b> Visibility reduction by helicopters NA. When local altimeter setting not received, use Rickenbacker Intl altimeter setting and increase all MDA 60 feet, S-28 Cat C visibility 1/8 mile, and Circling Cat C visibility 1/4 mile.</p>		<p><b>MISSED APPROACH:</b> Climbing left turn to 2700 direct CASER LOM and hold.</p>	
ASOS <b>118.375</b>	COLUMBUS APP CON <b>119.15 279.6</b>	CLNC DEL <b>121.65</b>	UNICOM <b>122.725 (CTAF) 0</b>

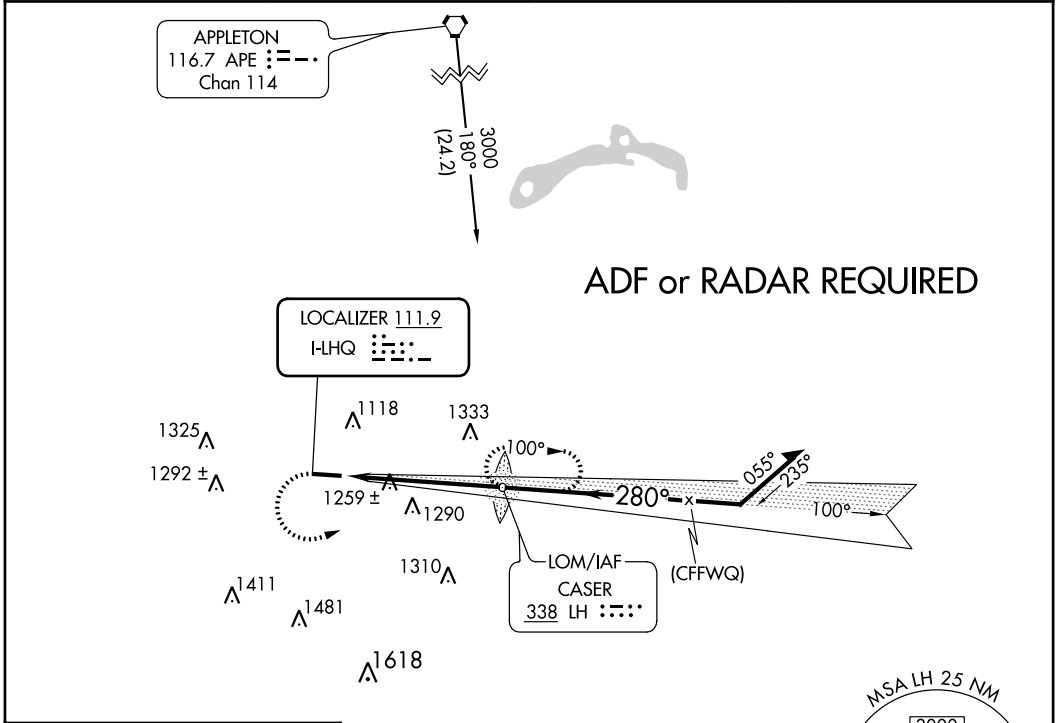

ELEV	868	THRE	868
------	-----	------	-----

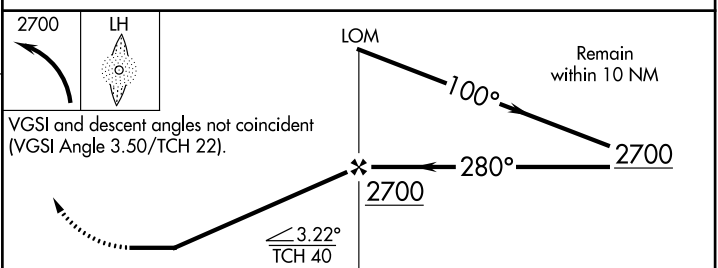
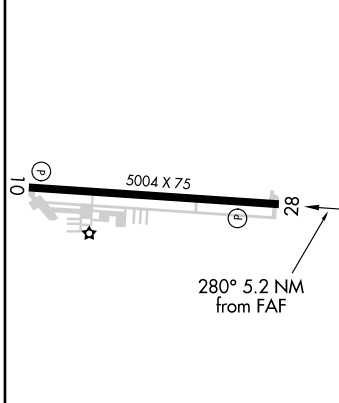

REIL Rwy 10 and 28  
HIRL Rwy 10-28

FAF to MAP 5.2 NM

Knots	60	90	120	150	180
Min:Sec	5:12	3:28	2:36	2:05	1:44

CATEGORY	A	B	C	D
S-28	1520-1 652 (700-1)	652 (700-1)	1520-1 7/8 652 (700-1 7/8)	NA
CIRCLING	1520-1 652 (700-1)	1540-1 672 (700-1)	1560-2 692 (700-2)	NA

LANCASTER, OHIO  
Amdt 2 15NOV12

39°45'N-82°39'W

LANCASTER/FAIRFIELD COUNTY (LHQ)  
**LOC RWY 28**

FIGURE 239.—LOC RWY 28 (LHQ).

PRICE, UTAH

AL-681 (FAA)

VOR/DME PUC <b>115.5</b> Chan <b>102</b>	APP CRS <b>009°</b>	Rwy Idg TDZE Apt Elev	<b>8313</b> <b>5835</b> <b>5953</b>
--	------------------------	-----------------------------	---

# VOR/DME RWY 36

PRICE/CARBON COUNTY RGNL/BUCK DAVIS FIELD (PUC)

<p><b>▼</b> <b>▲</b> Circling NA at night to Rwy 18, 25, and 32.</p>	<p>MALSF <b>▲</b> MISSED APPROACH: Climbing right turn to 10000 via heading 200° and PUC VOR/DME R-164 to FOSOV/12 DME and hold.</p>	
ASOS <b>135.425</b>	SALT LAKE CENTER <b>133.9 370.85</b>	UNICOM <b>122.8 (CTAF) 0</b>

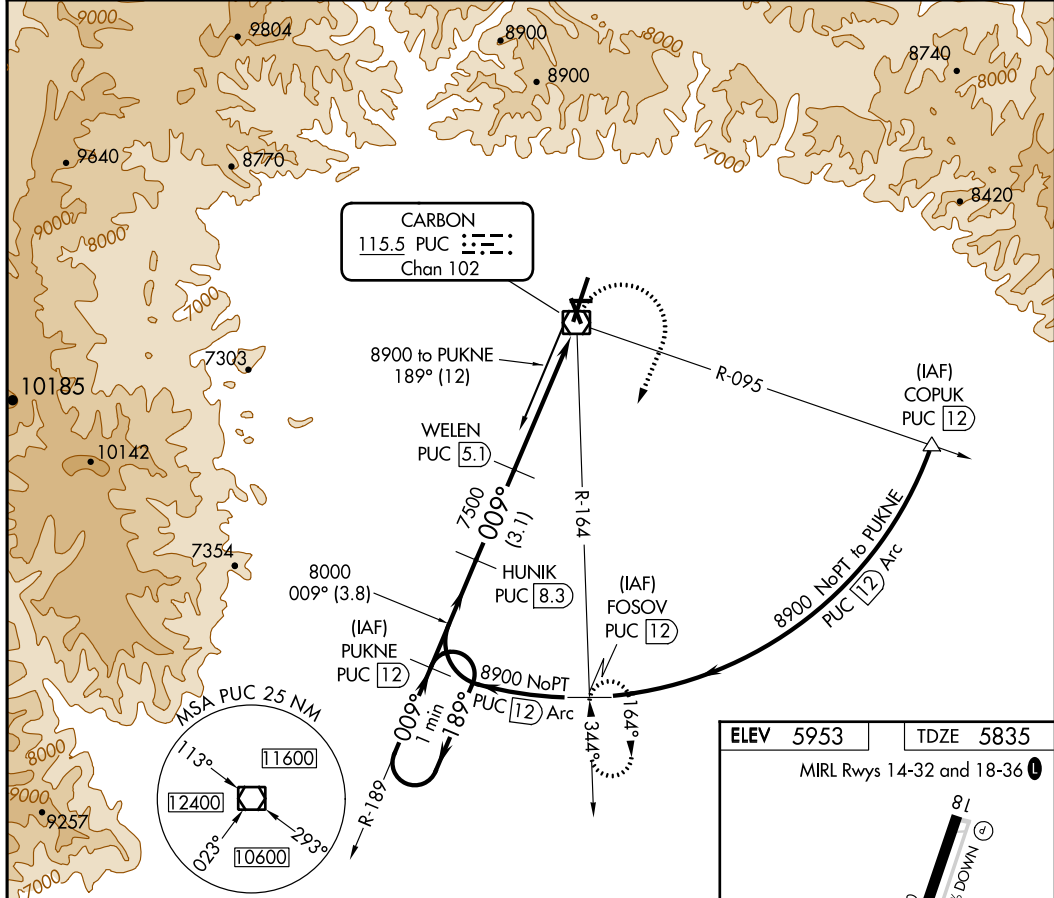

One Minute Holding Pattern	PUKNE PUC 12	HUNIK PUC 8.3	WELN PUC 5.1	10000 PUC R-164	FOSOV PUC 12
	8900 ← 189°	8000	7500	3.00° TCH 47	VOR/DME
VGSI and descent angles not coincident (VGSI Angle 3.00/TCH 52).					
CATEGORY	A	B	C	D	
S-36	6240-1	405 (300-1)	6240-1¼	405 (300-1¼)	
CIRCLING	6660-1 707 (800-1)	6740-1¼ 787 (800-1¼)	6820-2½ 867 (900-2½)	6980-3 1027 (1100-3)	

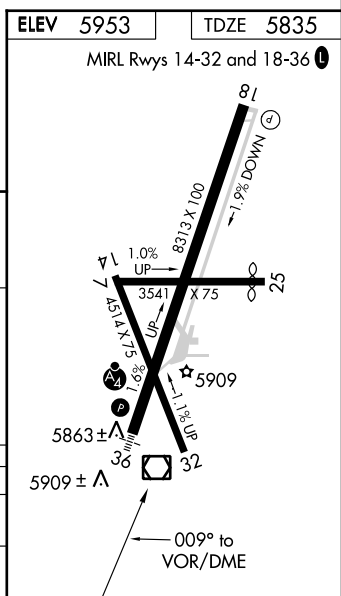

PRICE, UTAH  
Orig 12320

PRICE/CARBON COUNTY RGNL/BUCK DAVIS FIELD (PUC)  
39°37'N-110°45'W

# VOR/DME RWY 36

FIGURE 240.—VOR/DME RWY 36 (PUC).

PRICE, UTAH

AL-681 (FAA)

12320

WAAS CH <b>53425</b> <b>W36A</b>	APP CRS <b>004°</b>	Rwy Idg THRE Apt Elev <b>8313</b> <b>5812</b> <b>5957</b>
--	------------------------	--

# RNAV (GPS) RWY 36

PRICE/CARBON COUNTY RGNL/BUCK DAVIS FIELD (PUC)

	Circling to Rwy 25 NA at night. DME/DME RNP-0.3 NA.	MALSF 	MISSED APPROACH: Climbing right turn to 8900 direct WOKUP and hold.
--	--	-----------	--

ASOS <b>135.425</b>	SALT LAKE CENTER <b>133.9 370.85</b>	UNICOM <b>122.8 (CTAF) 0</b>
------------------------	---	---------------------------------

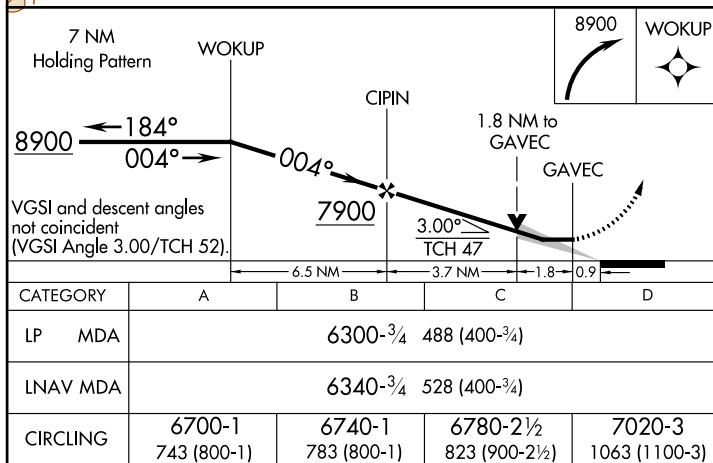
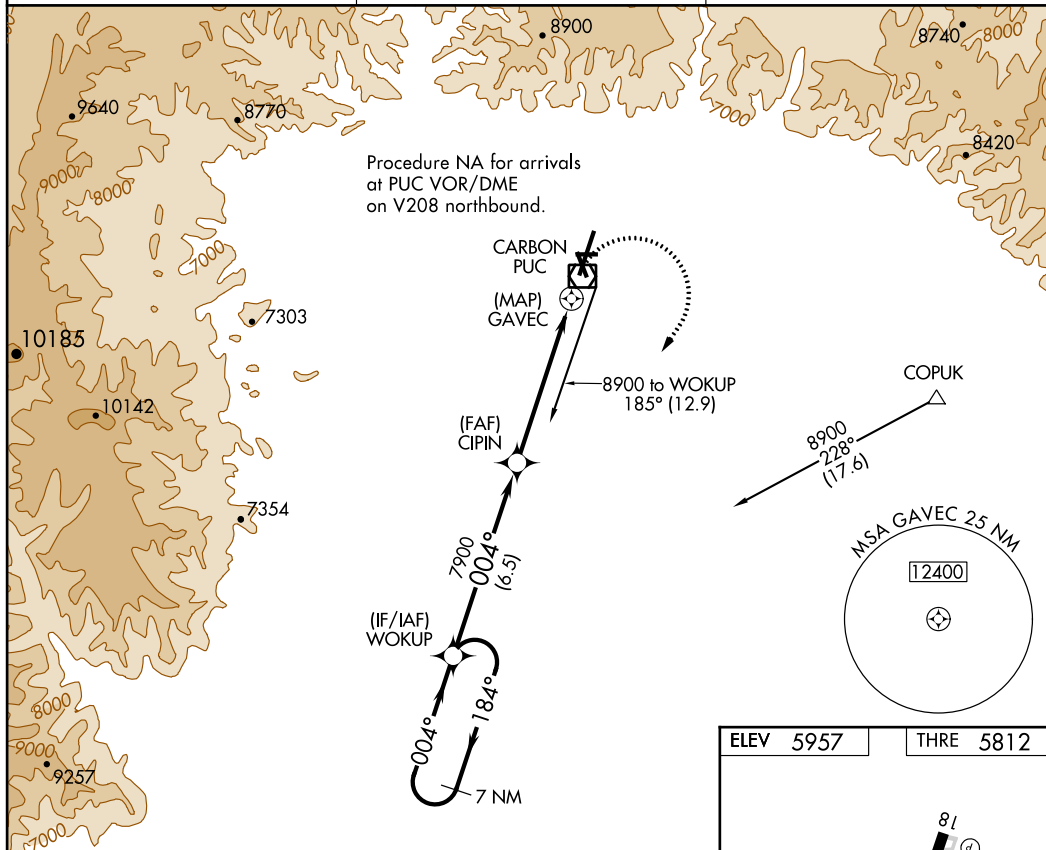

ELEV 5957	THRE 5812
MIRL Rwy 14-32 and 18-36 0	

PRICE, UTAH  
Amdt 1 25AUG11

PRICE/CARBON COUNTY RGNL/BUCK DAVIS FIELD (PUC)  
39°37'N-110°45'W  
**RNAV (GPS) RWY 36**

FIGURE 241.—RNAV (GPS) RWY 36 (PUC).

LITTLE ROCK, ARKANSAS

AL-233 (FAA)

12320

APP CRS	Rwy Idg	<b>6124</b>
<b>360°</b>	THRE	<b>253</b>
	Apt Elev	<b>266</b>

LITTLE ROCK/  
BILL AND HILLARY CLINTON NATIONAL/ADAMS FIELD (LIT)

# RNAV (GPS) RWY 36

ADAMS TOWER

**⚠** DME/DME RNP 0.3 NA. Visibility reduction by helicopters NA. When local altimeter setting not received, use Stuttgart altimeters setting and increase all MDA 100 feet. Increase LNAV Cat C/D and Circling Cat C visibility ¼ mile.

**⚠** MISSED APPROACH: Climbing right turn to 2700 direct HIGHS and hold.

ATIS	LITTLE ROCK APP CON	ADAMS TOWER	GND CON	CLNC DEL
<b>125.65</b>	<b>135.4 291.775 353.6</b>	<b>118.7 257.8</b>	<b>121.9 339.8</b>	<b>118.95</b>

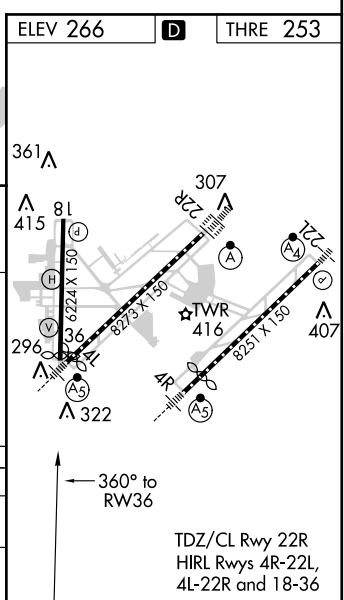
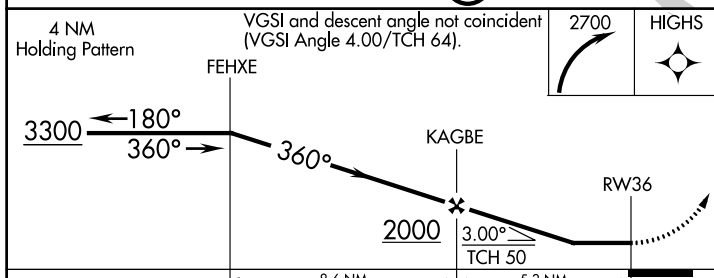
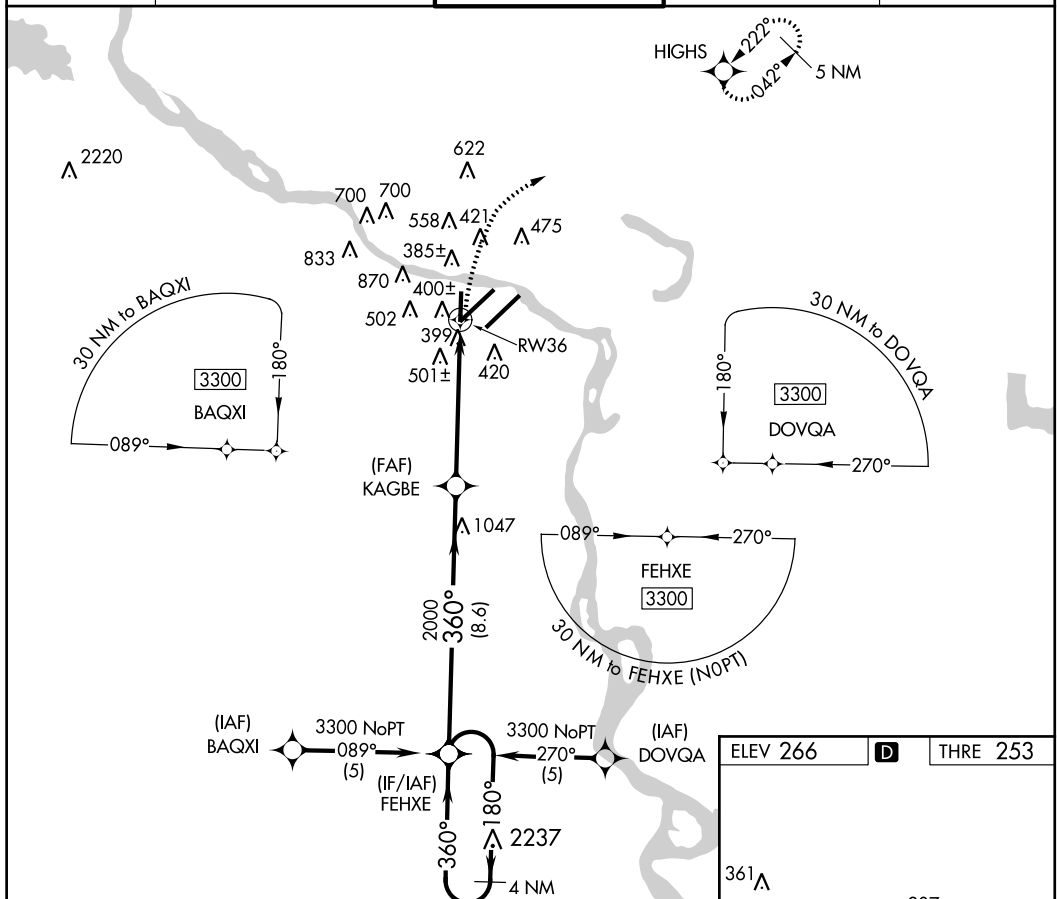

CATEGORY	A	B	C	D
LNAV MDA	760-1	507 (500-1)	760-1½	507 (500-1½)
CIRCLING	800-1	534 (600-1)	940-2 674 (700-1)	1180-3 914 (1000-3)

LITTLE ROCK, ARKANSAS  
Orig-A 10MAR11

LITTLE ROCK/ BILL AND HILLARY CLINTON NATIONAL/ADAMS FIELD (LIT)  
34°44'N - 92°13'W

# RNAV (GPS) RWY 36

FIGURE 242.—RNAV RWY 36 (LIT).

ROANOKE, VIRGINIA

AL-349 (FAA)

12320

WAAS CH <b>58222</b> <b>W06A</b>	APP CRS <b>072°</b>	Rwy Idg <b>6800</b> THRE <b>1152</b> Apt Elev <b>1175</b>
--	------------------------	---

# RNAV (GPS) RWY 6

ROANOKE RGNL/WOODRUM FIELD (ROA)

**⚠** Circling NA northwest of Rwy 6-24. DME/DME RNP-0.3 NA. Circling to Rwy 16 NA. For inop MALSR, increase LP Cat A/B visibility to 1 mile and Cats C/D visibility to 1½ mile and increase LNAV Cat A visibility to 1 mile, Cat B visibility to 1¼ mile and for Cats C/D inop table does not apply.

**MALS** MISSED APPROACH: Climbing right turn to 4000 direct DEWET and hold.

ATIS <b>132.375</b>	ROANOKE APP CON <b>126.9 339.8</b>	ROANOKE TOWER <b>118.3 257.8</b>	GND CON <b>121.9 257.8</b>	CLNC DEL <b>119.7</b>
------------------------	---------------------------------------	-------------------------------------	-------------------------------	--------------------------

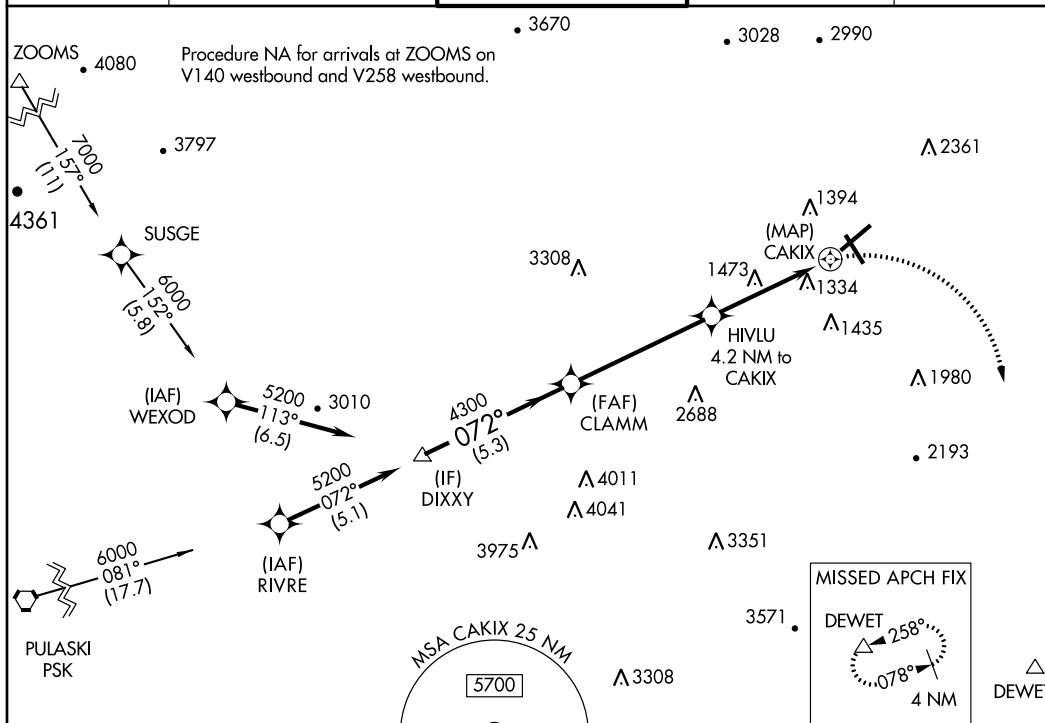

ELEV 1175	<b>D</b>	THRE 1152
-----------	----------	-----------

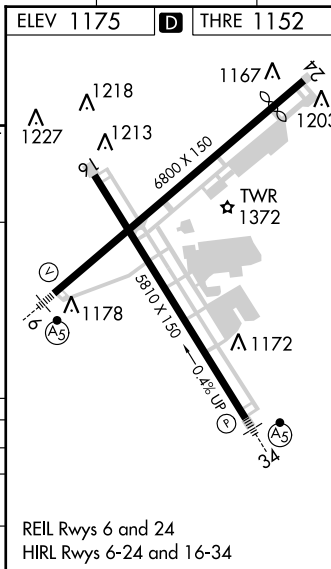
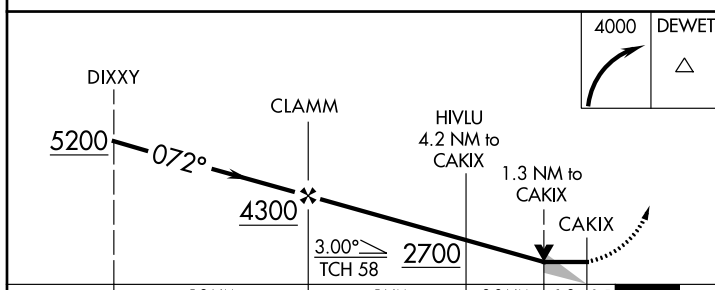

CATEGORY	A	B	C	D
LP MDA	1780-¾	628 (700-¾)	1780-1⅜	628 (700-1⅜)
LNAV MDA	2000-¾	848 (900-¾)	2000-2½	848 (900-2½)
CIRCLING	2000-1¼	825 (900-1¼)	2000-2½ 825 (900-2½)	2000-2¾ 825 (900-2¾)

ROANOKE, VIRGINIA  
Amdt 2 15NOV12

ROANOKE RGNL/WOODRUM FIELD (ROA)  
37°20'N - 79°59'W

# RNAV (GPS) RWY 6

FIGURE 243.—RNAV (GPS) RWY 6 (ROA).

ROANOKE, VIRGINIA

AL-349 (FAA)

12096

LOC/DME I-SZK <b>111.1</b> Chan <b>48</b>	APP CRS <b>072°</b>	Rwy ldg <b>6800</b> THRE <b>1152</b> Apt Elev <b>1175</b>
---	------------------------	---

**LDA RWY 6**  
ROANOKE RGNL/WOODRUM FIELD (ROA)

**⚠** Inoperative table does not apply to S-LDA 6. Circling NA NW of Rwy 6-24. Circling NA to Rwy 16. SKIRT minimums: For inoperative MALSRS, increase S-LDA 6 Cats A and B visibility to 1½ and Cats C and D visibility to 1¾.

**MALSRS** 

**MISSED APPROACH:** Climb to 1820 then climbing right turn to 5000 on heading 189° and ROA VORTAC R-149 to JEXOV INT/ROA 22 DME and hold.

ATIS <b>132.375</b>	ROANOKE APP CON <b>126.9 339.8</b>	ROANOKE TOWER <b>118.3 257.8</b>	GND CON <b>121.9 257.8</b>	CLNC DEL <b>119.7</b>
------------------------	---------------------------------------	-------------------------------------	-------------------------------	--------------------------

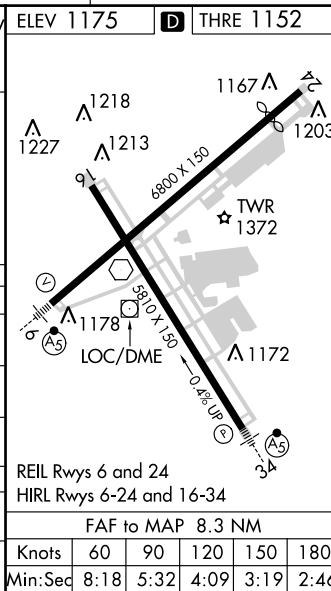
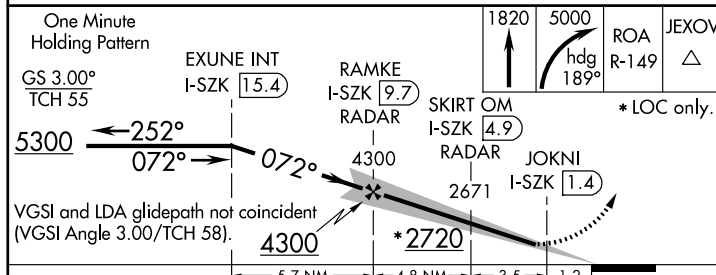
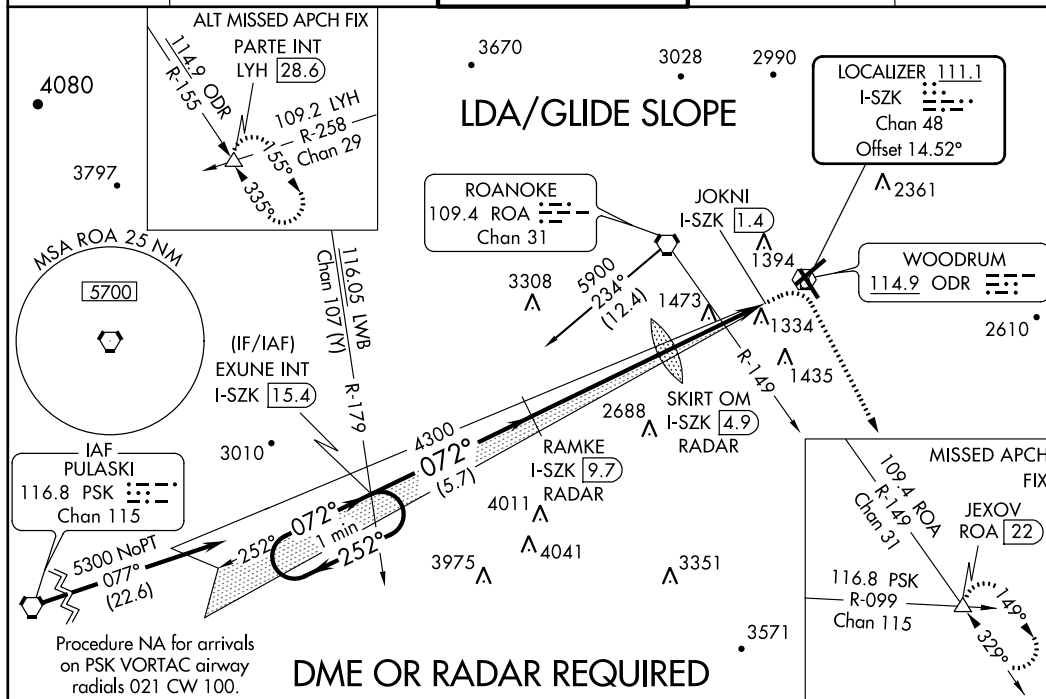

CATEGORY	A	B	C	D
S-LDA/GS 6	1605-1		453 (500-1)	
S-LDA 6	2720-1½	1568 (1600-1½)	2720-3	1568 (1600-3)
CIRCLING	2720-1½	1545 (1600-1½)	2720-3	1545 (1600-3)
SKIRT OM/DME/RADAR MINIMUMS				
S-LDA 6	1780-1	628 (700-1)	1780-1¾	628 (700-1¾)
CIRCLING	1780-1½	605 (700-1½)	1780-1¾	605 (700-1¾)
			1780-2	605 (700-2)

ROANOKE, VIRGINIA  
Amdt 11 12JAN12

ROANOKE RGNL/WOODRUM FIELD (ROA)  
**LDA RWY 6**

37°20'N-79°59'W

FIGURE 244.—LDA RWY 6 (ROA).

CHATHAM, MASSACHUSETTS

AL-5247 (FAA)

11293

APP CRS <b>240°</b>	Rwy Idg TDZE Apt Elev	<b>N/A</b> <b>N/A</b> <b>63</b>
------------------------	-----------------------------	---------------------------------------

**RNAV (GPS)-B**  
CHATHAM MUNI (CQX)

**⚠** DME/DME RNP-0.3 NA. When local altimeter setting not received, use Hyannis altimeter setting and increase all MDA 40 feet. MISSED APPROACH: Climbing left turn to 3000 direct CEPUL and hold.

ASOS <b>135.875</b>	CAPE APP CON ★ <b>118.2</b>	CLNC DEL <b>127.3</b>	UNICOM <b>122.8</b> (CTAF)	<b>122.95</b> <b>0</b>
------------------------	--------------------------------	--------------------------	-------------------------------	------------------------

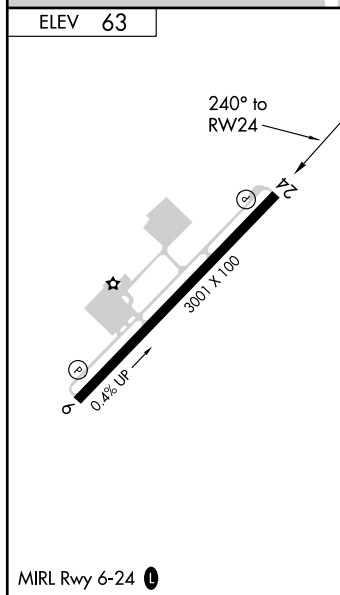
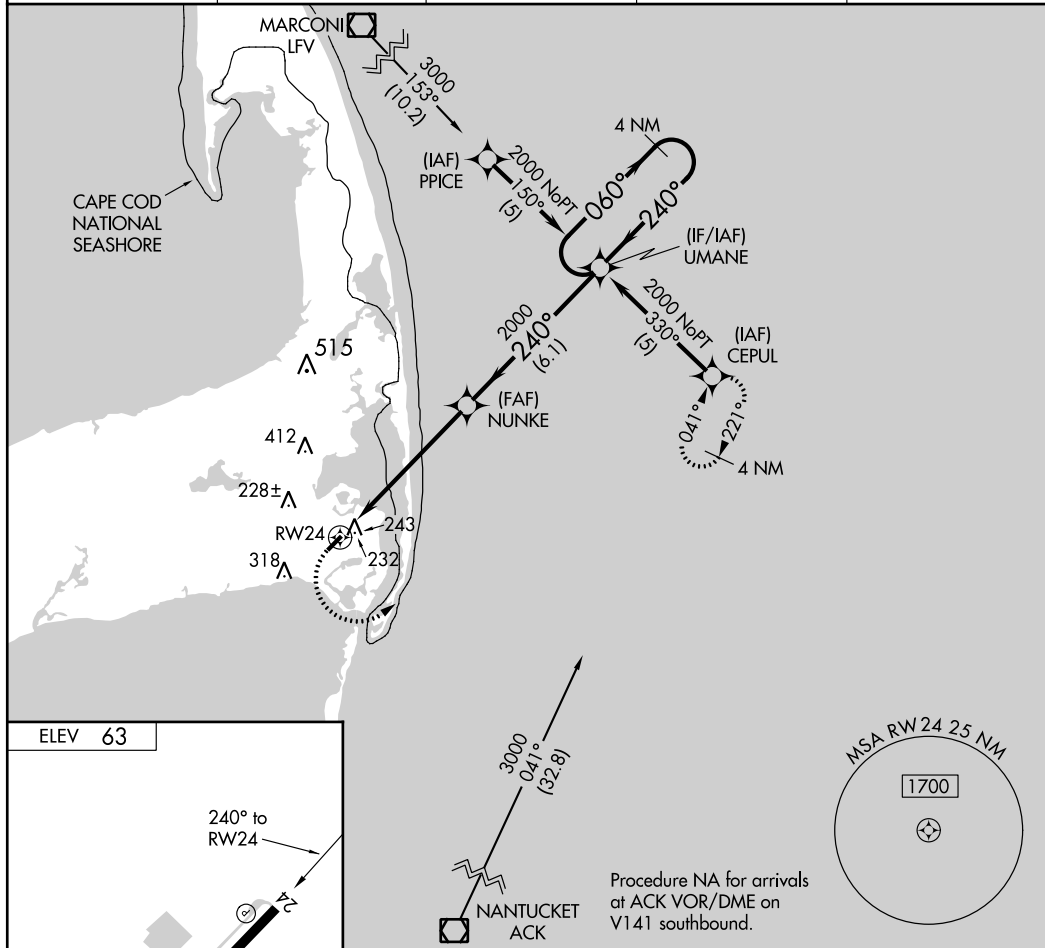

3000	CEPUL	VGSI and descent angles not coincident (VGSI Angle 3.50/TCH 45).	4 NM Holding Pattern	
CATEGORY	A	B	C	D
CIRCLING	600-1	537 (600-1)	680-1 <sup>3</sup> / <sub>4</sub> 617 (700-1 <sup>3</sup> / <sub>4</sub> )	680-2 617 (700-2)

CHATHAM, MASSACHUSETTS  
Orig-A 26AUG10

41°41'N - 69°59'W

CHATHAM MUNI (CQX)  
**RNAV (GPS)-B**

FIGURE 245.—RNAV (GPS)-B (CQX).



RIVERSIDE, CALIFORNIA

AL-769 (FAA)

13234

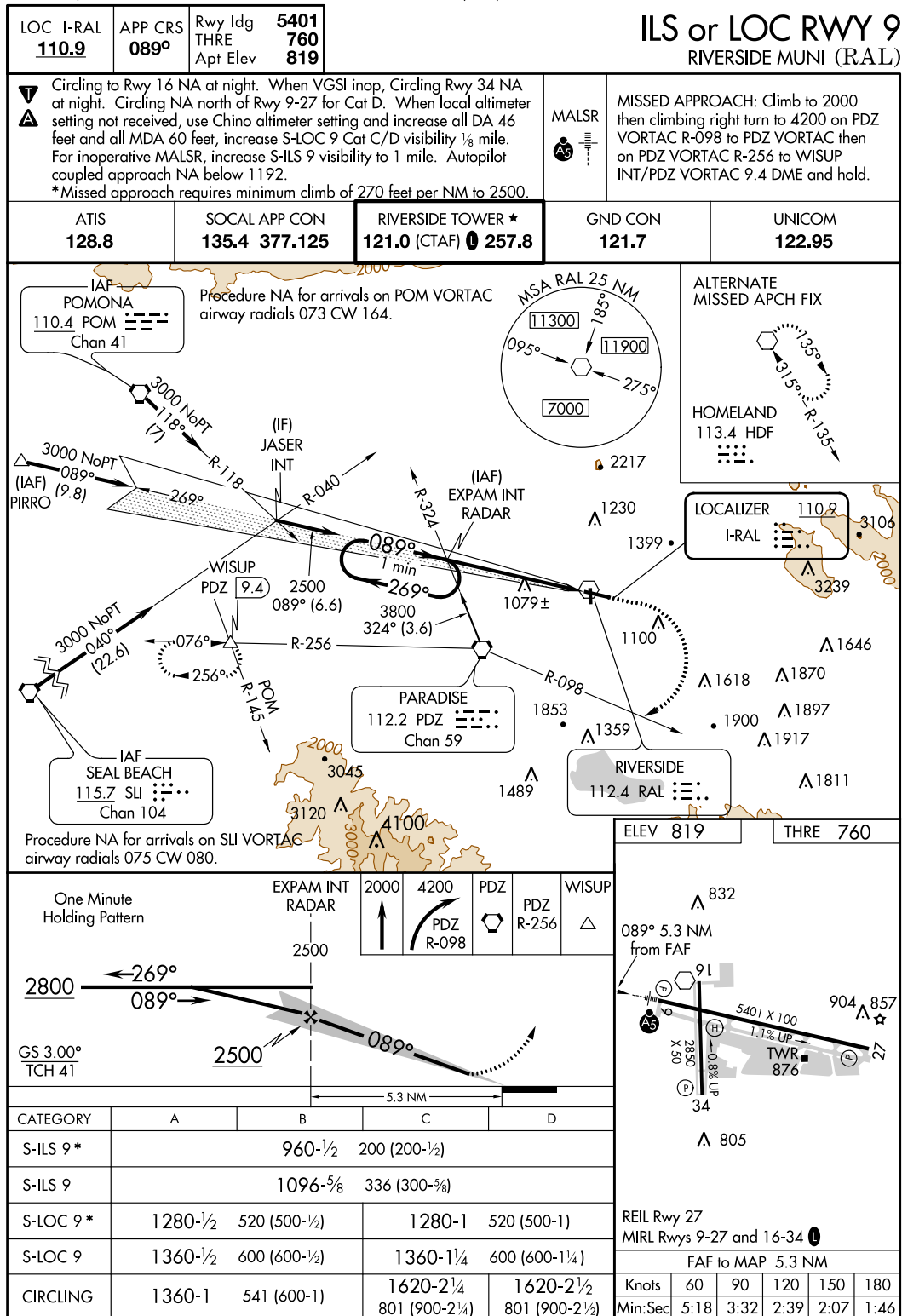

RIVERSIDE, CALIFORNIA

Amdt 8A 22AUG13

33°57'N-117°27'W

RIVERSIDE MUNI (RAL)  
**ILS or LOC RWY 9**

FIGURE 247.—ILS or RWY 9 (RAL).

Appendix 2

RIVERSIDE, CALIFORNIA

AL-769 (FAA)

**RNAV (GPS) RWY 27**  
RIVERSIDE MUNI (RAL)

WAAS CH <b>82201</b> <b>W27A</b>	APP CRS <b>269°</b>	Rwy Idg TDZE Apt Elev	<b>5401</b> <b>818</b> <b>818</b>
--	------------------------	-----------------------------	---

**▽** DME/DME RNP -0.3 NA.  
**▲** For uncompensated Baro-VNAV systems, LNAV/VNAV NA below -16°C (4°F) or above 46°C (116°F).  
Circling NA for Cat D north of Rwy 9-27.  
Visibility reduction by helicopters NA.

MISSED APPROACH: Climb to 4000 direct ICIYE and via 246° track to PRADO and hold.

ATIS <b>128.8</b>	SOCAL APP CON <b>135.4 377.125</b>	RIVERSIDE TOWER ★ <b>121.0</b> (CTAF) <b>0 257.8</b>	GND CON <b>121.7</b>	UNICOM <b>122.95</b>
----------------------	---------------------------------------	---	-------------------------	-------------------------

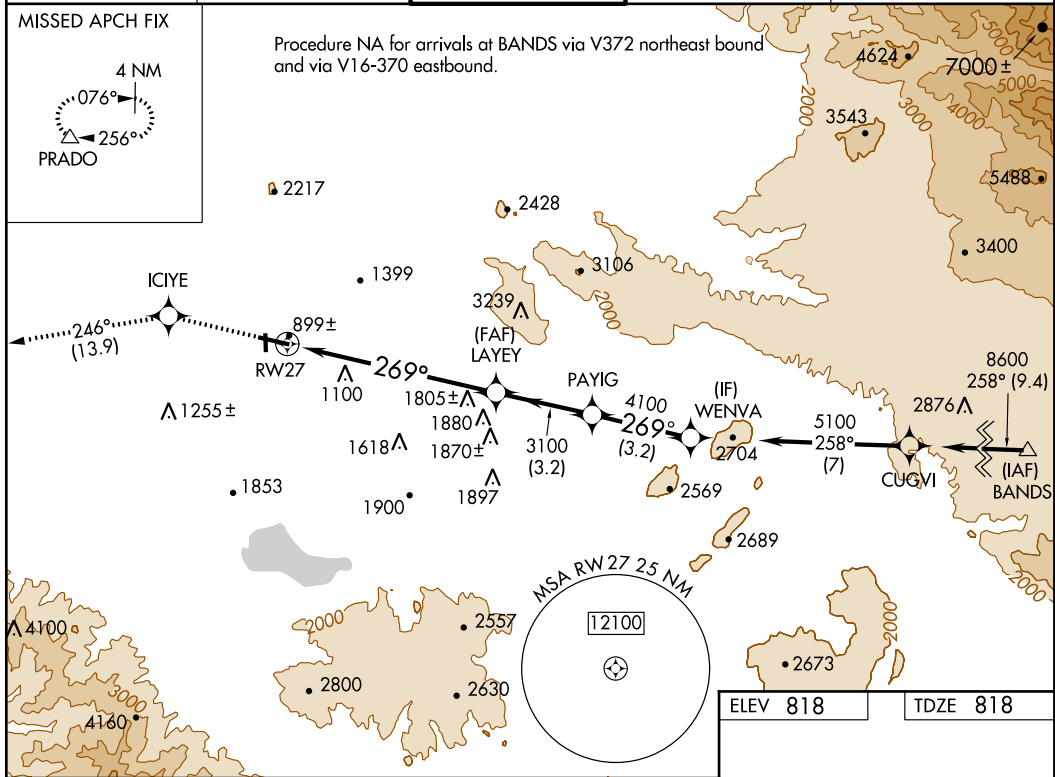

CATEGORY	A	B	C	D
LPV DA	1236-1½		418 (500-1½)	
LNAV/VNAV DA	1368-2		550 (600-2)	
LNAV MDA	2100-1¼ 1282 (1300-1¼)	2100-1½ 1282 (1300-1½)	2100-3	1282 (1300-3)
CIRCLING	2100-2	1282 (1300-2)	2100-3	1282 (1300-3)

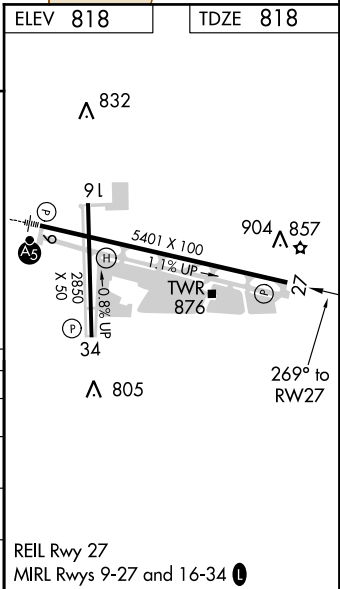

RIVERSIDE, CALIFORNIA  
Orig 12040

33°57'N-117°27'W

RIVERSIDE MUNI (RAL)  
**RNAV (GPS) RWY 27**

FIGURE 248.—RNAV (GPS) RWY 27 (RAL).

NORTH PLATTE, NEBRASKA

AL-292 (FAA)

13262

WAAS CH <b>60915</b> <b>W30A</b>	APP CRS <b>300°</b>	Rwy Idg THRE Apt Elev	<b>8001</b> <b>2769</b> <b>2777</b>
--	------------------------	-----------------------------	---

# RNAV (GPS) RWY 30

NORTH PLATTE RGNL AIRPORT LEE BIRD FIELD (LBF)

**▽** For uncompensated Baro-VNAV systems, LNAV/VNAV NA below -23°C (-9°F) or above 52°C (126°F). DME/DME RNP-0.3 NA. Circling to Rwy 17 NA at night.  
**▲** MALSR

MISSED APPROACH: Climb to 4900 direct AGHAN and hold.

ASOS <b>118.425</b>	DENVER CENTER <b>132.7 226.675</b>	CLNC DEL <b>132.7</b>	UNICOM <b>123.0 (CTAF) 0</b>
------------------------	---------------------------------------	--------------------------	---------------------------------

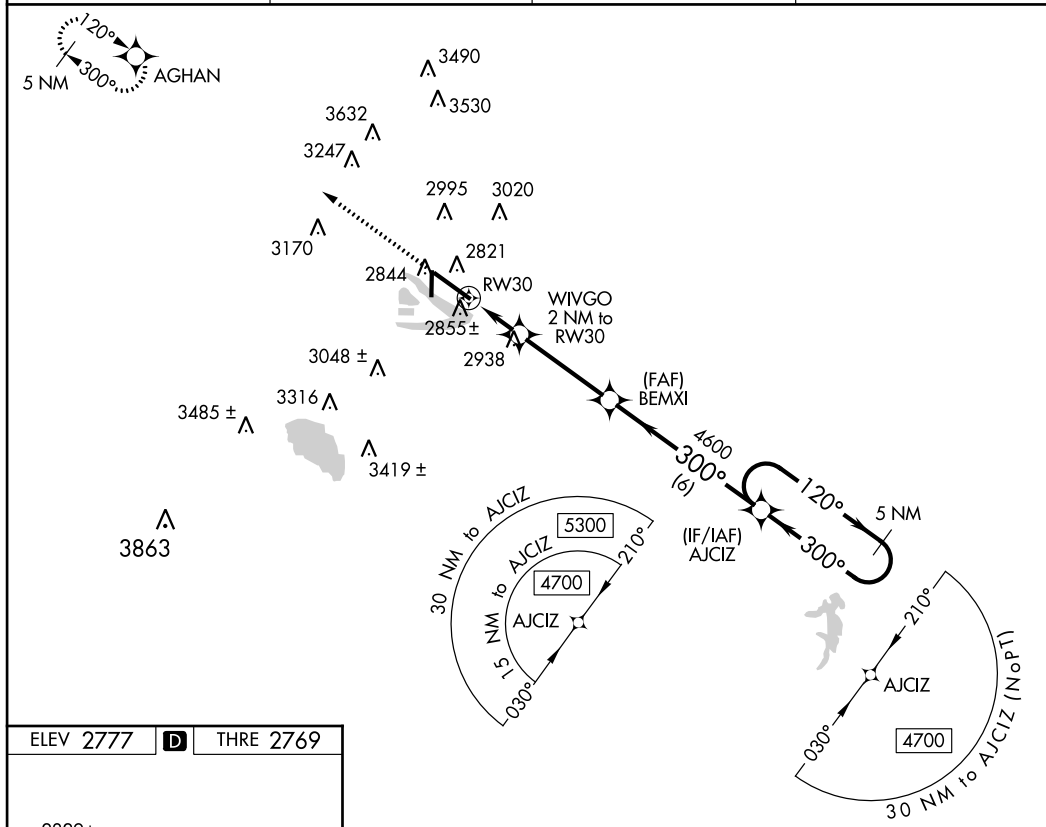

ELEV 2777 **D** THRE 2769

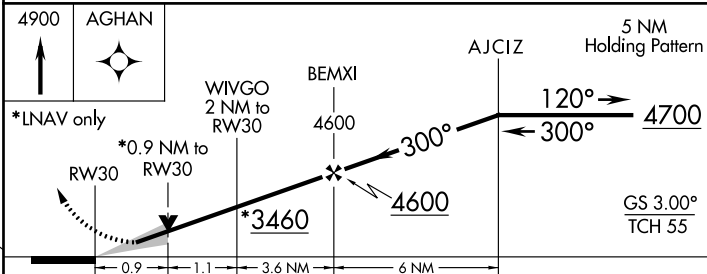
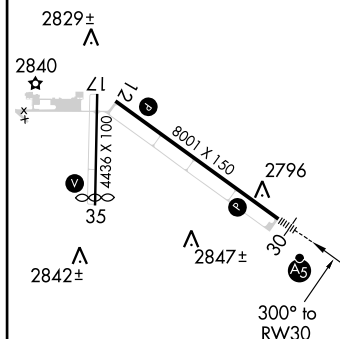

CATEGORY	A	B	C	D
LPV DA	2969-1/2		200 (200-1/2)	
LNAV/VNAV DA	3019-1/2		250 (300-1/2)	
LNAV MDA	3120-1/2	351 (400-1/2)	3120-5/8	351 (400-5/8)
<b>C</b> CIRCLING	3280-1 503 (600-1)	3320-1 543 (600-1)	3420-1 3/4 643 (700-1 3/4)	3560-2 1/2 783 (800-2 1/2)

HIRL Rwy 12-30 **L**  
 REIL Rwy 35 **L**  
 MIRL Rwy 17-35 **L**

NORTH PLATTE, NEBRASKA  
 Amdt 2 19SEP13

NORTH PLATTE RGNL AIRPORT LEE BIRD FIELD (LBF)  
 41°08'N-100°41'W  
**RNAV (GPS) RWY 30**

FIGURE 249.—RNAV (GPS) RWY 30 (LBF).

NORRIDGEWOCK, MAINE

AL-6642 (FAA)

13290

APP CRS	Rwy Idg	<b>3999</b>
<b>028°</b>	TDZE	<b>268</b>
	Apt Elev	<b>270</b>

**GPS RWY 3**  
CENTRAL MAINE AIRPORT OF NORRIDGEWOCK (OWK)

<p>▼ Use Augusta State altimeter setting. ▲ NA Procedure NA at night. ▲ NA Visibility reduction by helicopters NA.</p>	<p>MISSED APPROACH: Climbing left turn to 2300 direct UCCOX WP and hold.</p>
--	--

<p>AWOS-AV <b>122.8</b></p>	<p>PORTLAND APP CON ★ <b>128.35 299.2</b></p>	<p>UNICOM <b>122.8 (CTAF) 0</b></p>
---------------------------------	---	---

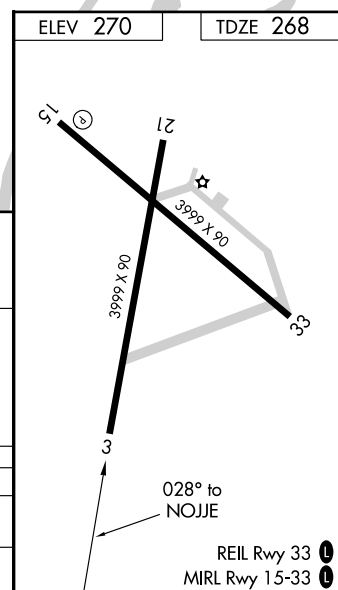
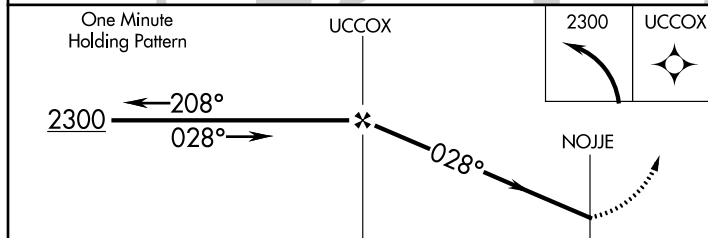
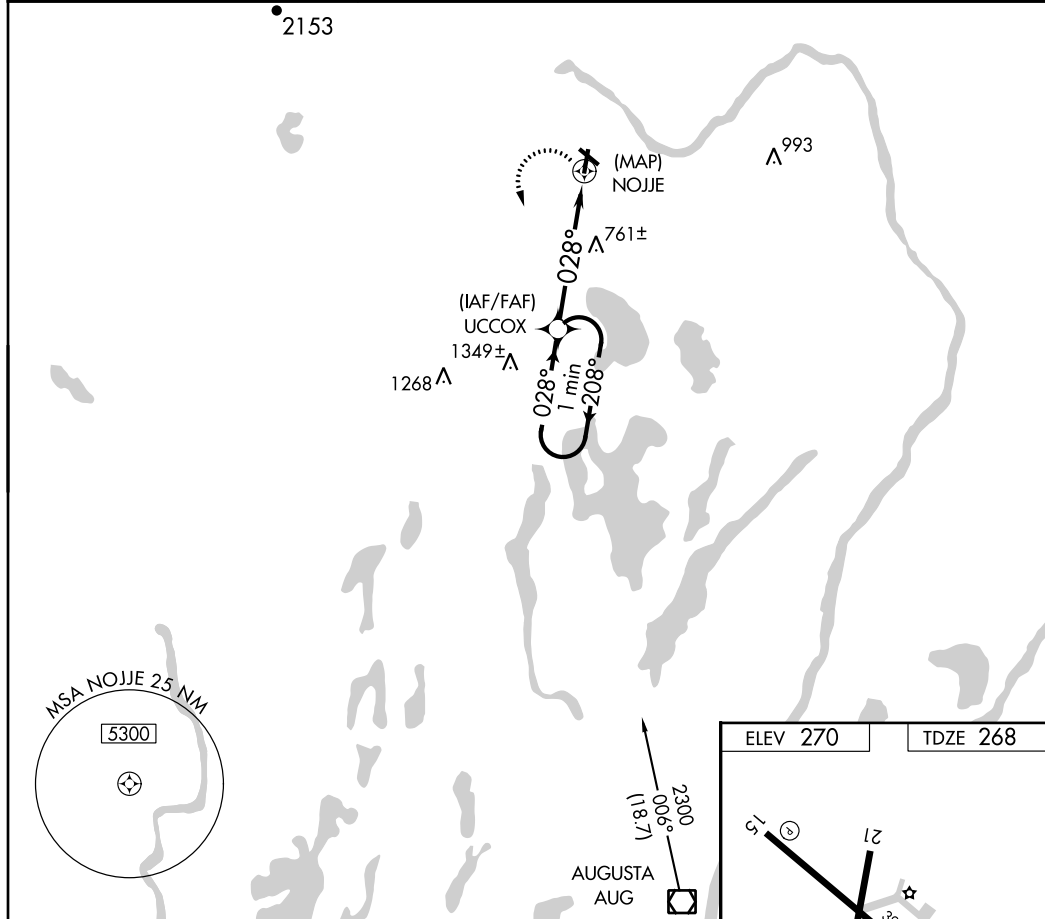

CATEGORY	A	B	C	D
S-3	1080-1 812 (900-1)	1080-1¼ 812 (900-1¼)	1080-2½ 812 (900-2½)	NA
CIRCLING	1080-1 810 (900-1)	1080-1¼ 810 (900-1¼)	1080-2½ 810 (900-2½)	NA

NORRIDGEWOCK, MAINE  
Orig-A 03MAY12

CENTRAL MAINE AIRPORT OF NORRIDGEWOCK (OWK)  
44°43'N-69°52'W  
**GPS RWY 3**

FIGURE 250.—GPS RWY 3 (OWK).

12264

# AIRPORT DIAGRAM

AL-730 (FAA)

OSHKOSH/ WITTMAN RGNL (OSH)  
OSHKOSH, WISCONSIN

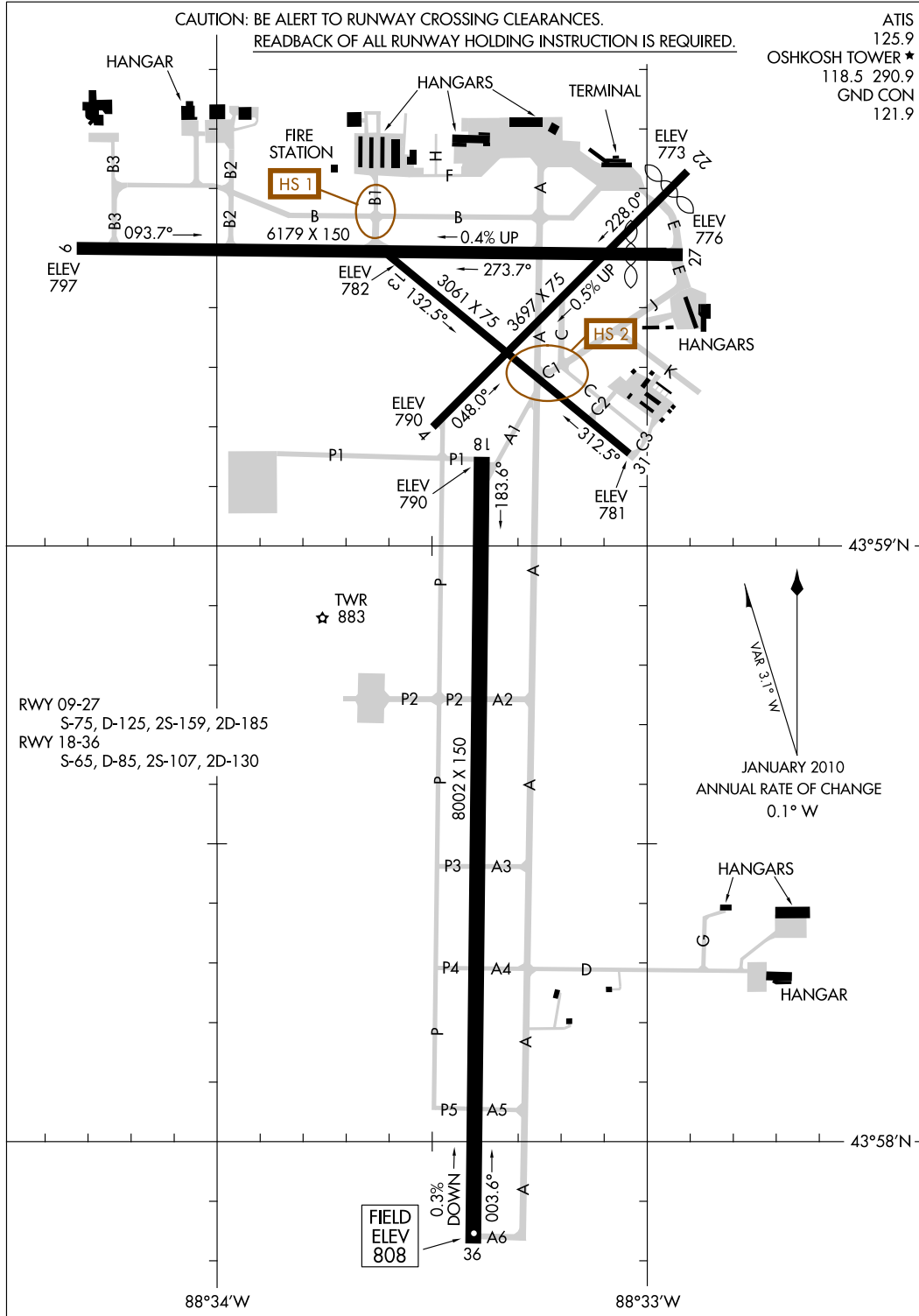

# AIRPORT DIAGRAM

12264

OSHKOSH, WISCONSIN  
OSHKOSH/ WITTMAN RGNL (OSH)

FIGURE 251.—Airport Diagram: Osh Kosh/Wittman Regional (OSH).

Appendix 2

OSHKOSH, WISCONSIN

AL-730 (FAA)

13234

LOC I-OSH <b>110.5</b>	APP CRS <b>004°</b>	Rwy ldg THRE Apt Elev	<b>8002</b> <b>808</b> <b>808</b>
---------------------------	------------------------	-----------------------------	---

**ILS or LOC RWY 36**  
OSHKOSH/ WITTMAN RGNL (OSH)

▼ When local altimeter setting not received, use Fond Du Lac altimeter setting and increase DA 31 feet and all MDA 40 feet; increase S-LOC 36 Cat C/D and Circling Cat C/D visibilities ¼ mile. For inop MALS when using Fond Du Lac altimeter setting, increase S-LOC 36 Cat C/D visibility to 1½ mile. Circling to Rwy 5, 23, and 31 NA at night.  
\* RVR 1800 authorized with the use of FD or AP or HUD to DA.



MISSED APPROACH: Climb to 1300 then climbing right turn to 3000 on OSH R-111 to LEWKO INT/OSH 15 DME and hold.

ATIS <b>125.9</b>	MILWAUKEE APP CON <b>127.0 263.075</b>	OSHKOSH TOWER ★ <b>118.5 (CTAF) 290.9</b>	GND CON <b>121.9</b>	UNICOM <b>122.95</b>
----------------------	---	--	-------------------------	-------------------------

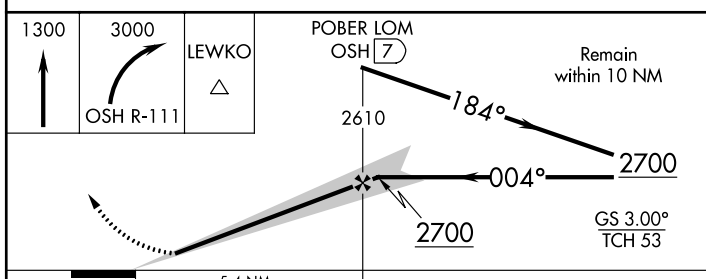
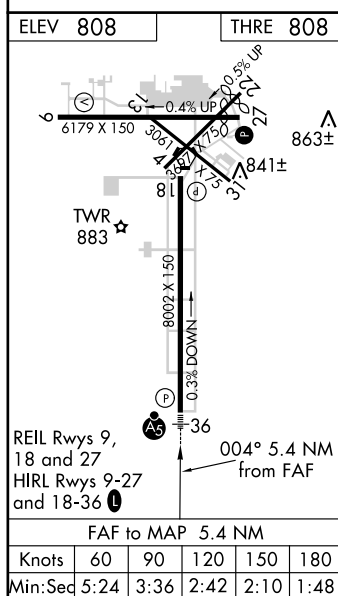
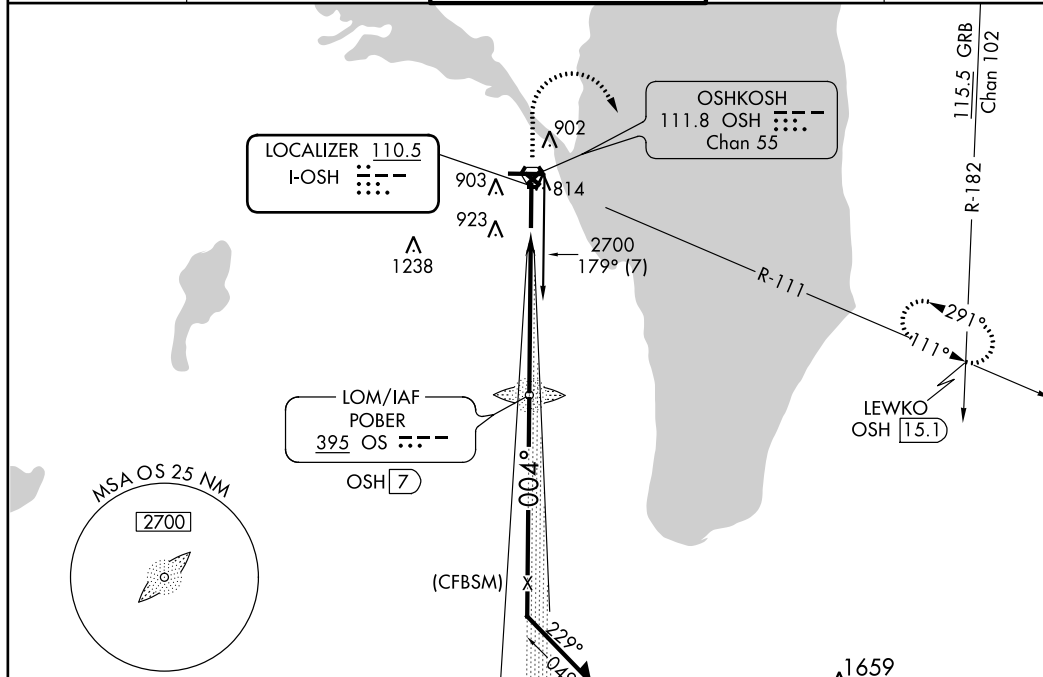

CATEGORY	A	B	C	D
S-ILS 36 *	1008/24 200 (200-½)			
S-LOC 36	1340/24	532 (600-½)	1340/55	532 (600-1¼)
CIRCLING	1340-1	532 (600-1)	1360-1½	1440-2
			552 (600-1½)	632 (700-2)

OSHKOSH, WISCONSIN  
Amdt 7 22AUG13

43°59'N-88°33'W

OSHKOSH/ WITTMAN RGNL (OSH)  
**ILS or LOC RWY 36**

FIGURE 252.—ILS or LOC RWY 36 (OSH).

OSHKOSH, WISCONSIN

AL-730 (FAA)

13234

WAAS CH <b>58333</b> <b>W18A</b>	APP CRS <b>184°</b>	Rwy Idg THRE <b>790</b> Apt Elev <b>808</b>
--	------------------------	--

# RNAV (GPS) RWY 18

OSHKOSH/ WITTMAN RGNL (OSH)

**⚠** For uncompensated Baro-VNAV systems, LNAV/VNAV NA below -20°C (-4°F) or above 54°C (130°F). VDP and Baro-VNAV NA when using Fond Du Lac altimeter setting. When local altimeter setting not received, use Fond Du Lac altimeter setting and increase all DA 31 feet and all MDA 40 feet; increase LPV and LNAV/VNAV all Cats visibility 1/8 mile, increase LNAV Cat C/D and Circling Cat D visibility 1/4 mile. Helicopter visibility reduction below 1/4 SM NA. Circling to Rwy 5, 23 and 31 NA at night. DME/DME RNP-0.3 NA.

**MISSED APPROACH:** Climb to 2800 direct DOCEN and hold.

ATIS <b>125.9</b>	MILWAUKEE APP CON <b>127.0 263.075</b>	OSHKOSH TOWER ★ <b>118.5 (CTAF) 290.9</b>	GND CON <b>121.9</b>	UNICOM <b>122.95</b>
----------------------	---	--	-------------------------	-------------------------

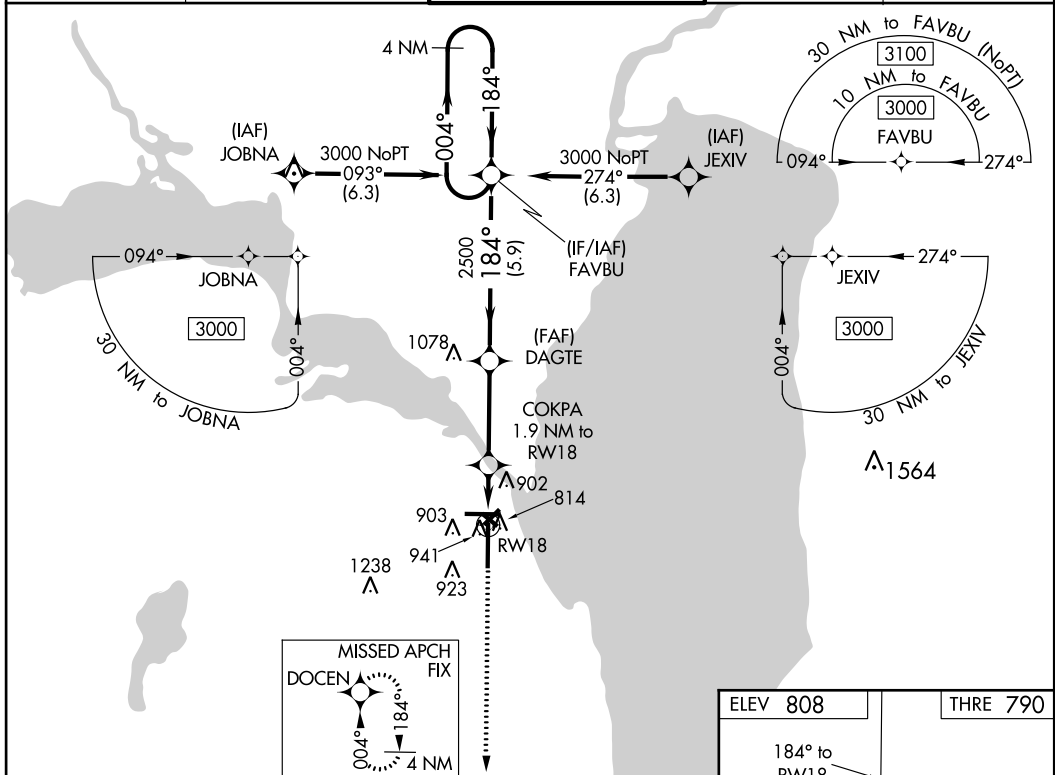

4 NM Holding Pattern		FAVBU	DAGTE	COKPA	2800	DOCEN
3000 ← 004°		→ 184°	2500	1.9 NM to RW18	↑	★
GS 3.00°		→ 184°	*1440	*1.1 NM to RW18		
TCH 47		→ 184°		RW18		
		→ 184°				
		→ 184°				
CATEGORY	A	B	C	D		
LPV DA	1040-3/4 250 (300-3/4)					
LNAV/VNAV DA	1118-1 3/8 328 (400-1 1/8)					
LNAV MDA	1200-1	410 (500-1)	1200-1 1/8	410 (500-1 1/8)		
CIRCLING	1280-1 472 (500-1)	1300-1 492 (500-1)	1360-1 1/2 552 (600-1 1/2)	1440-2 632 (700-2)	REIL Rws 9, 18, and 27 HIRL Rws 9-27, and 18-36	

OSHKOSH, WISCONSIN  
Amdt 1 22AUG13

43°59'N-88°33'W

# OSHKOSH/ WITTMAN RGNL (OSH) RNAV (GPS) RWY 18

FIGURE 253.—RNAV (GPS) RWY 18 (OSH).

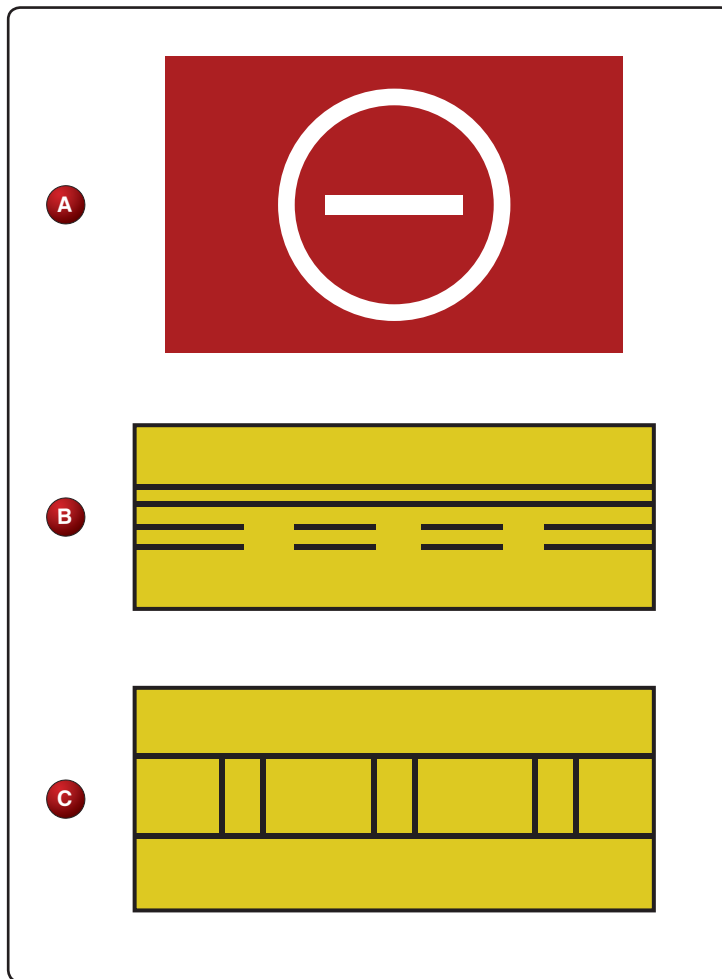

FIGURE 254.—Airport Sign.



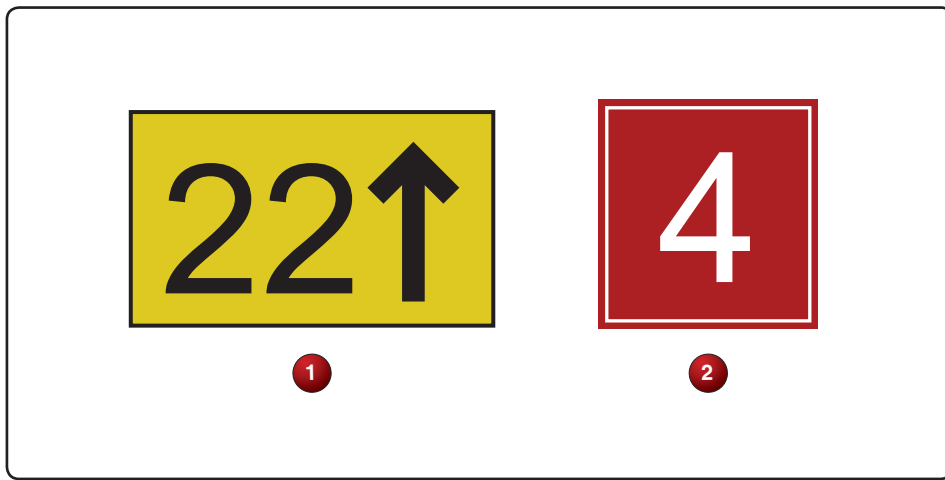

FIGURE 255.—Two Signs.

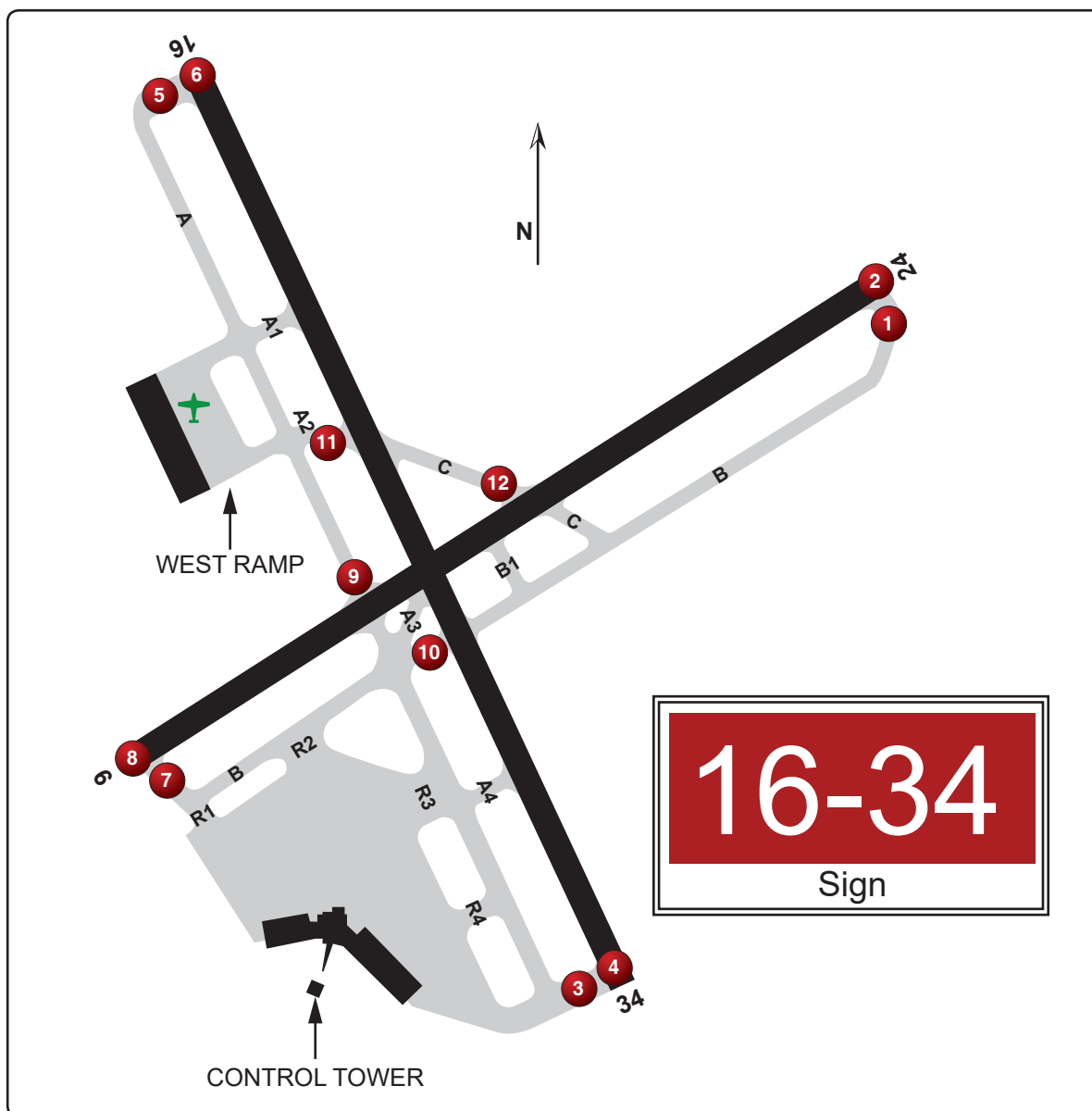

FIGURE 256.—Airport Diagram and Sign.

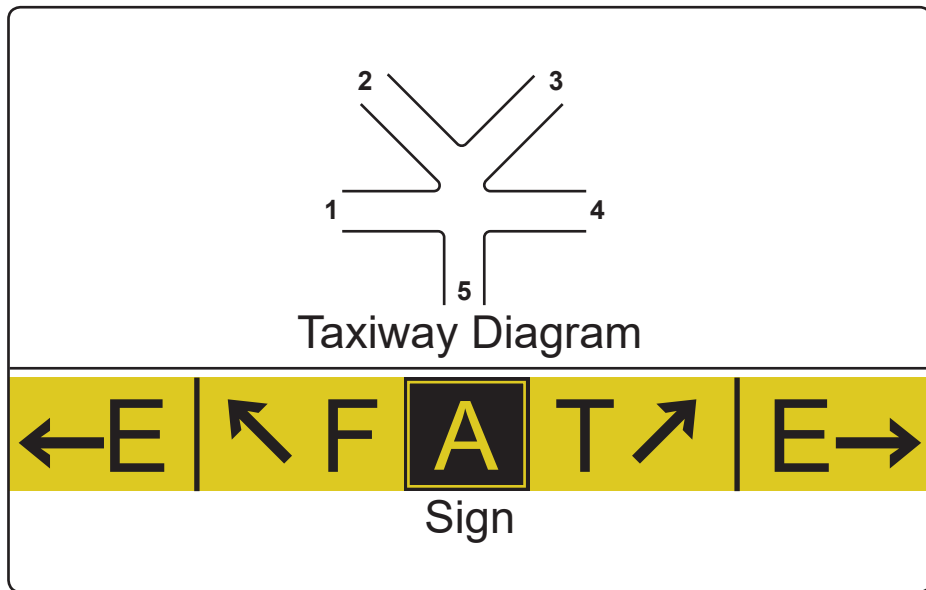

FIGURE 257.—Taxiway Diagram and Sign.



FIGURE 258.—Instrument Landing System (ILS) Critical Area Markings.

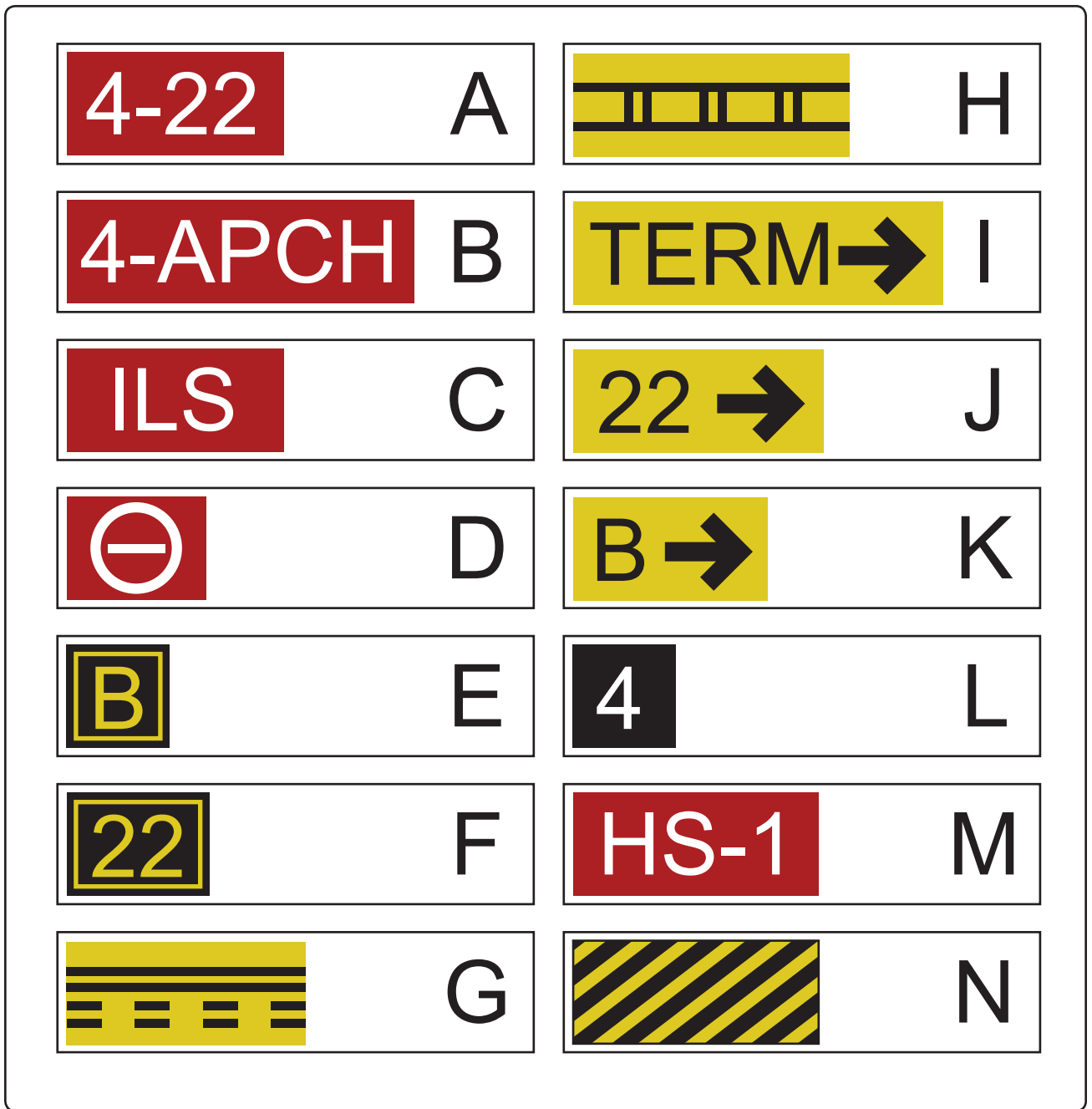

FIGURE 259.—Airport Signs.

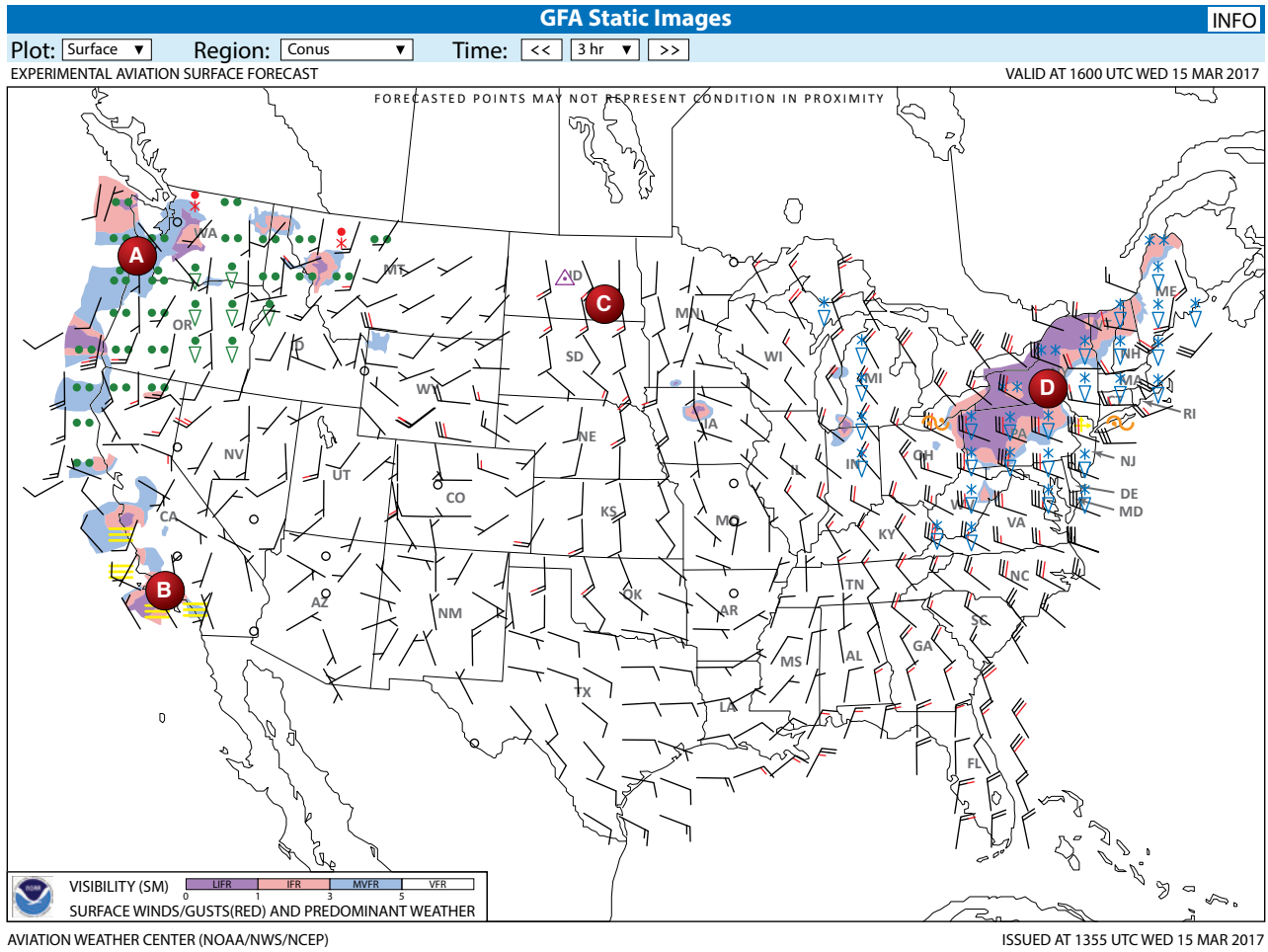

FIGURE 260.—Graphical Forecast for Aviation.

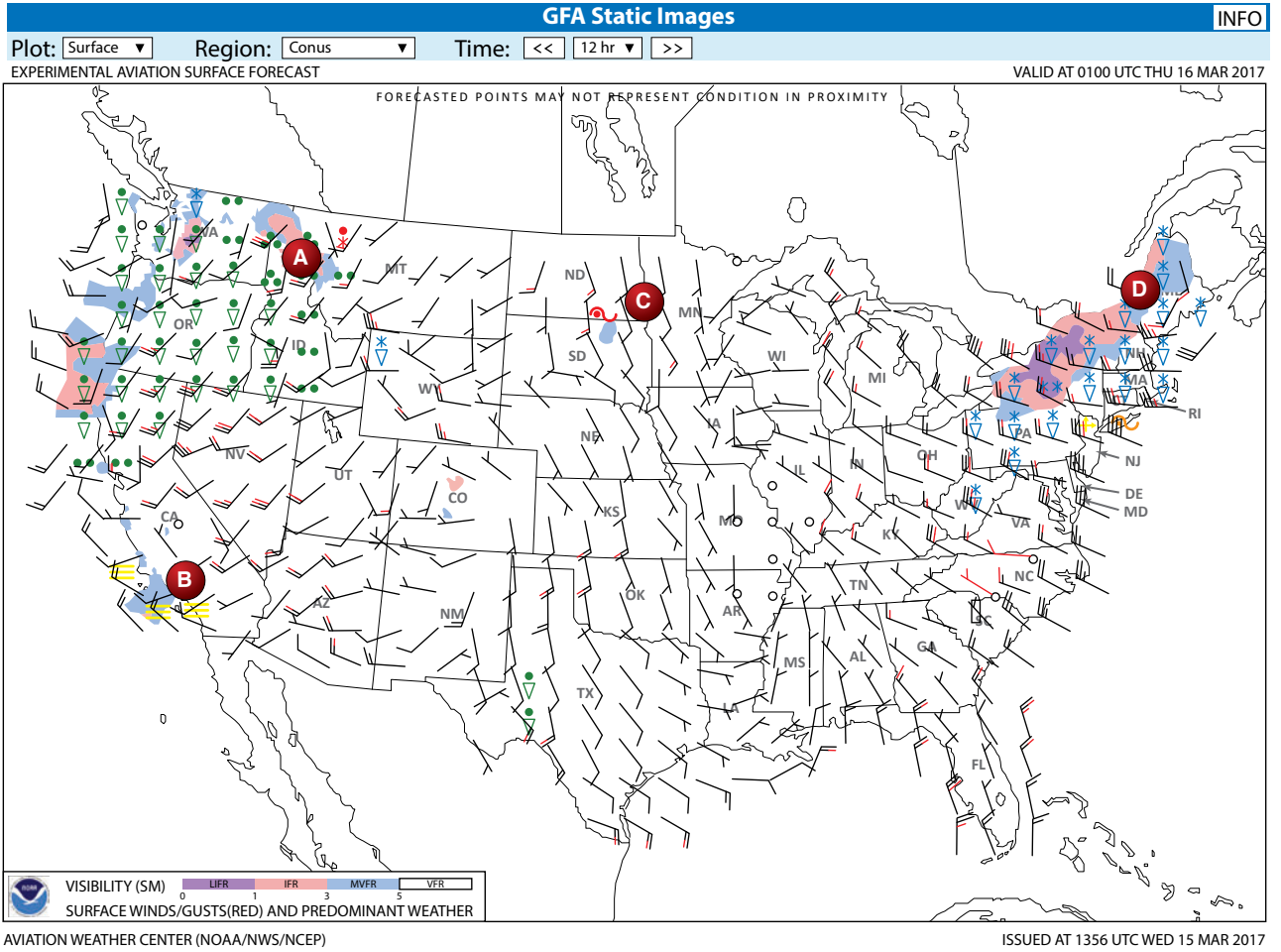

FIGURE 261.—Graphical Forecast for Aviation.

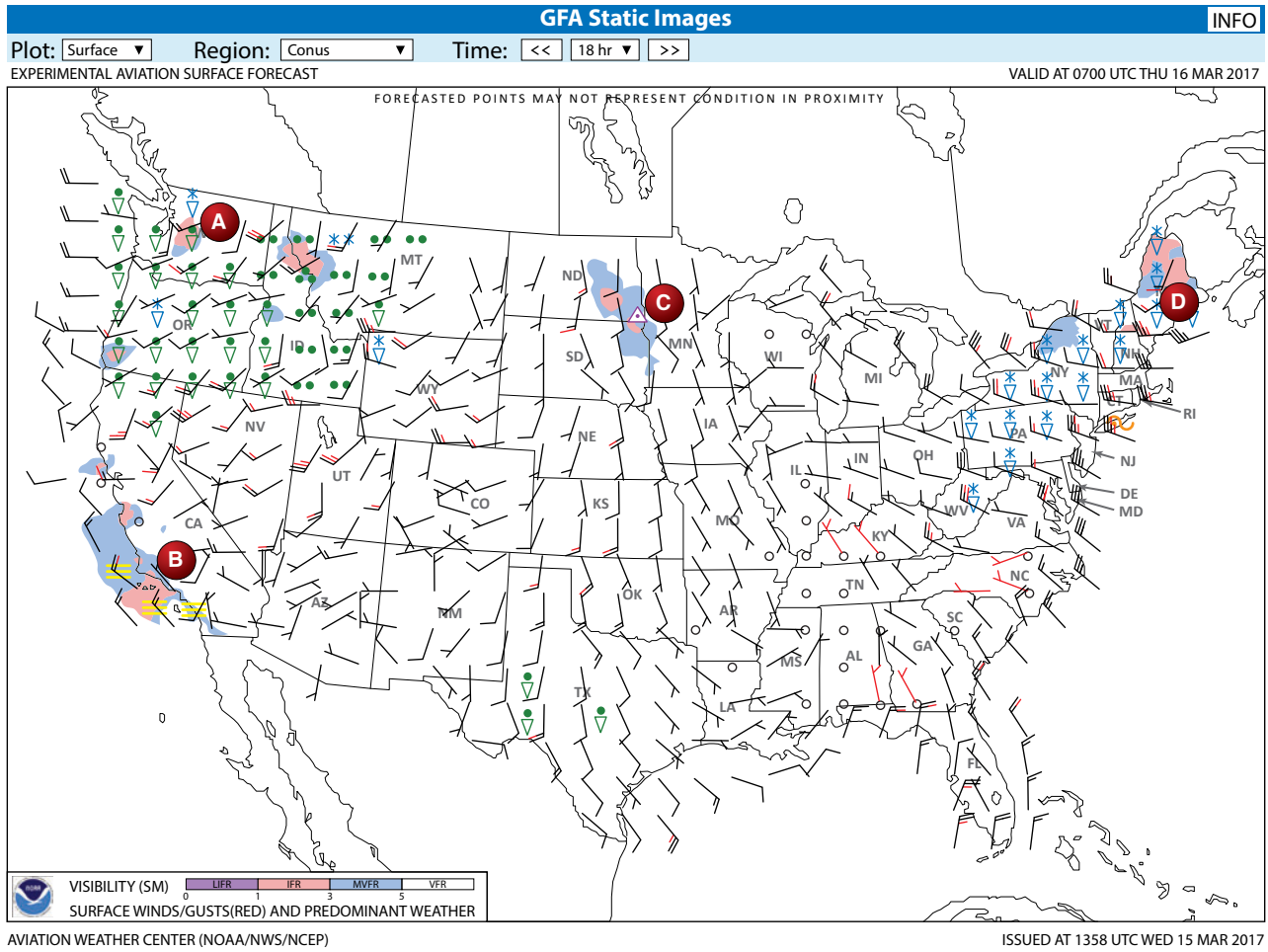

FIGURE 262.—Graphical Forecast for Aviation.



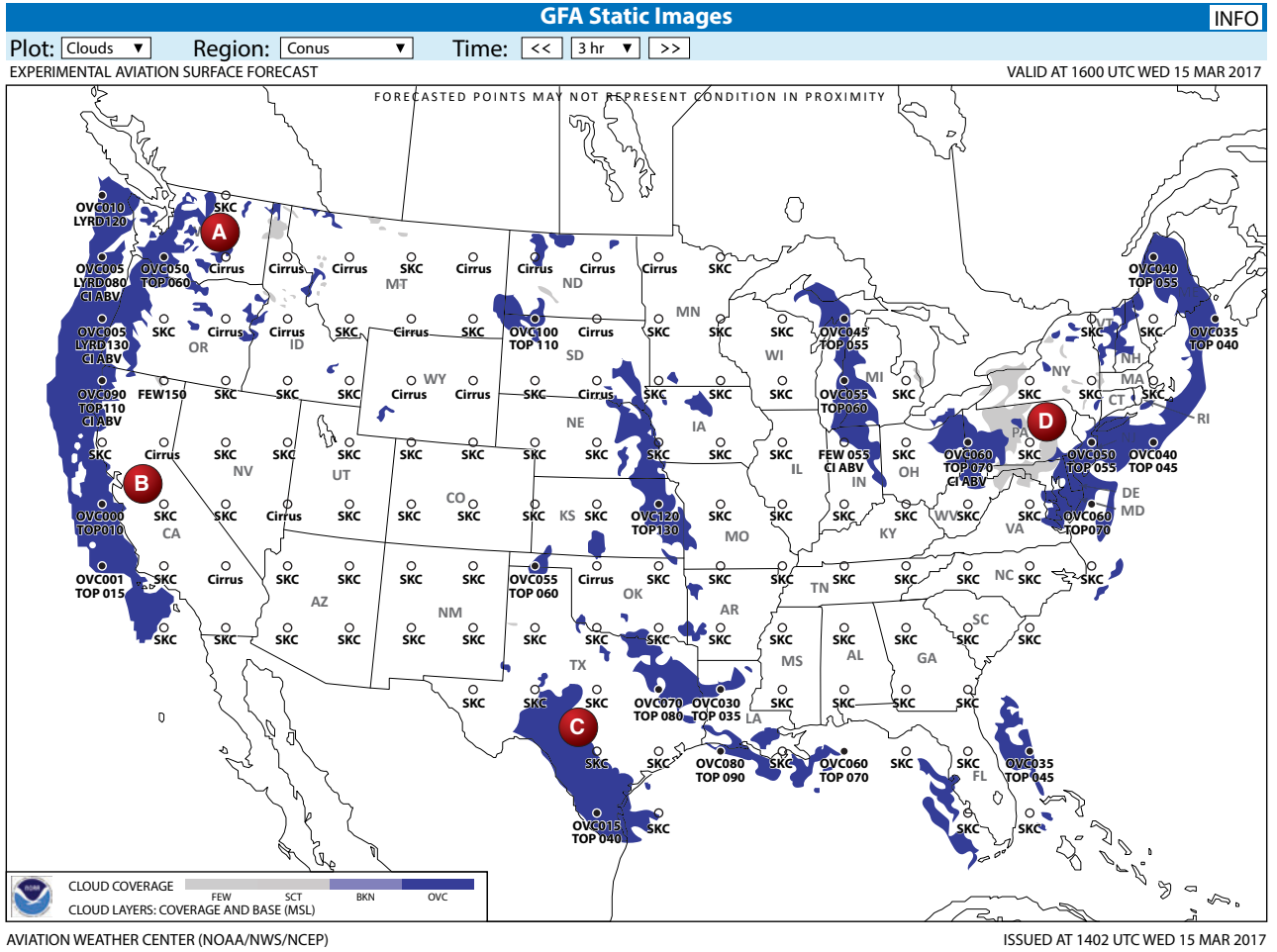

FIGURE 263.—Graphical Forecast for Aviation.

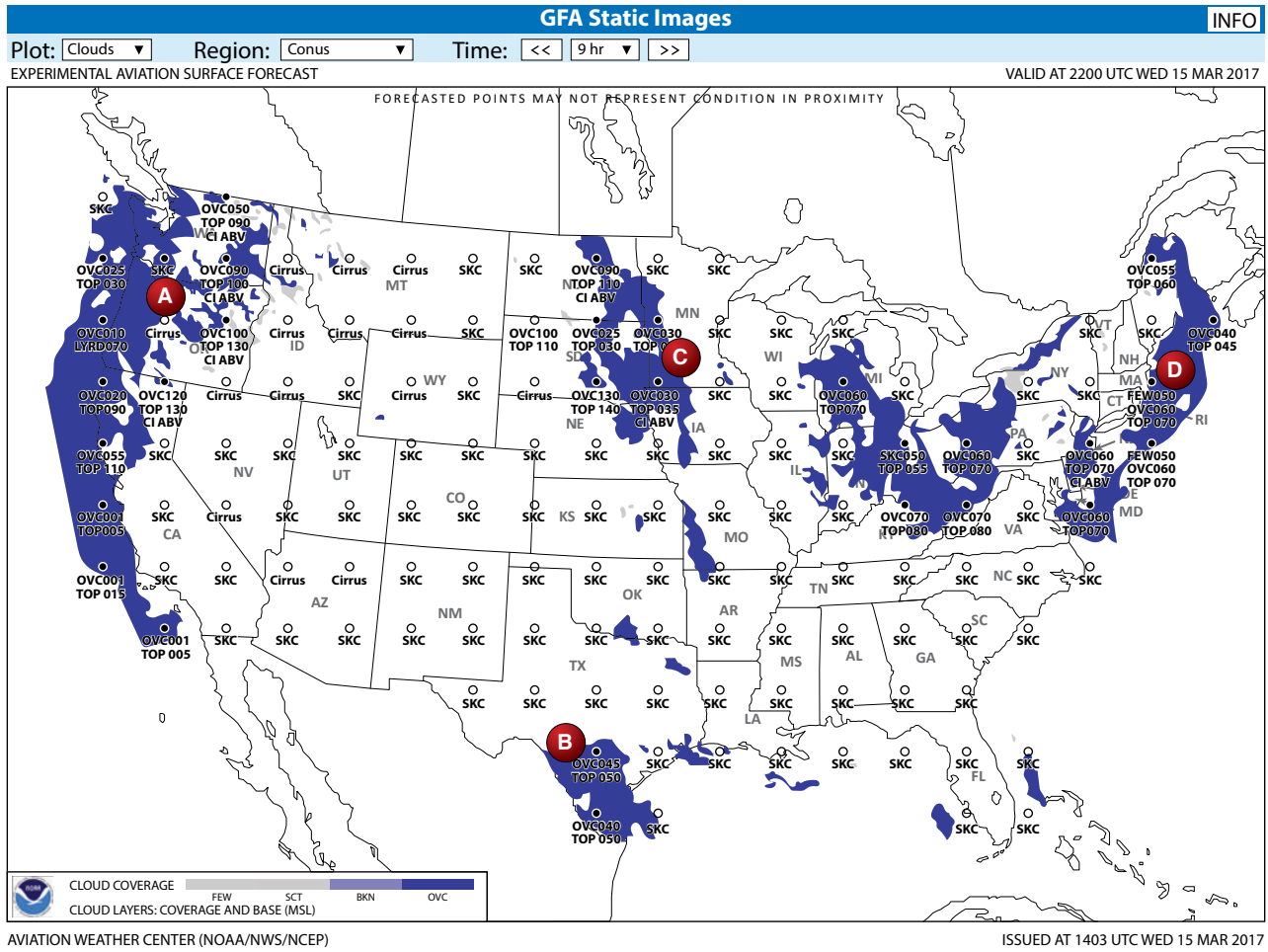

FIGURE 264.—Graphical Forecast for Aviation.

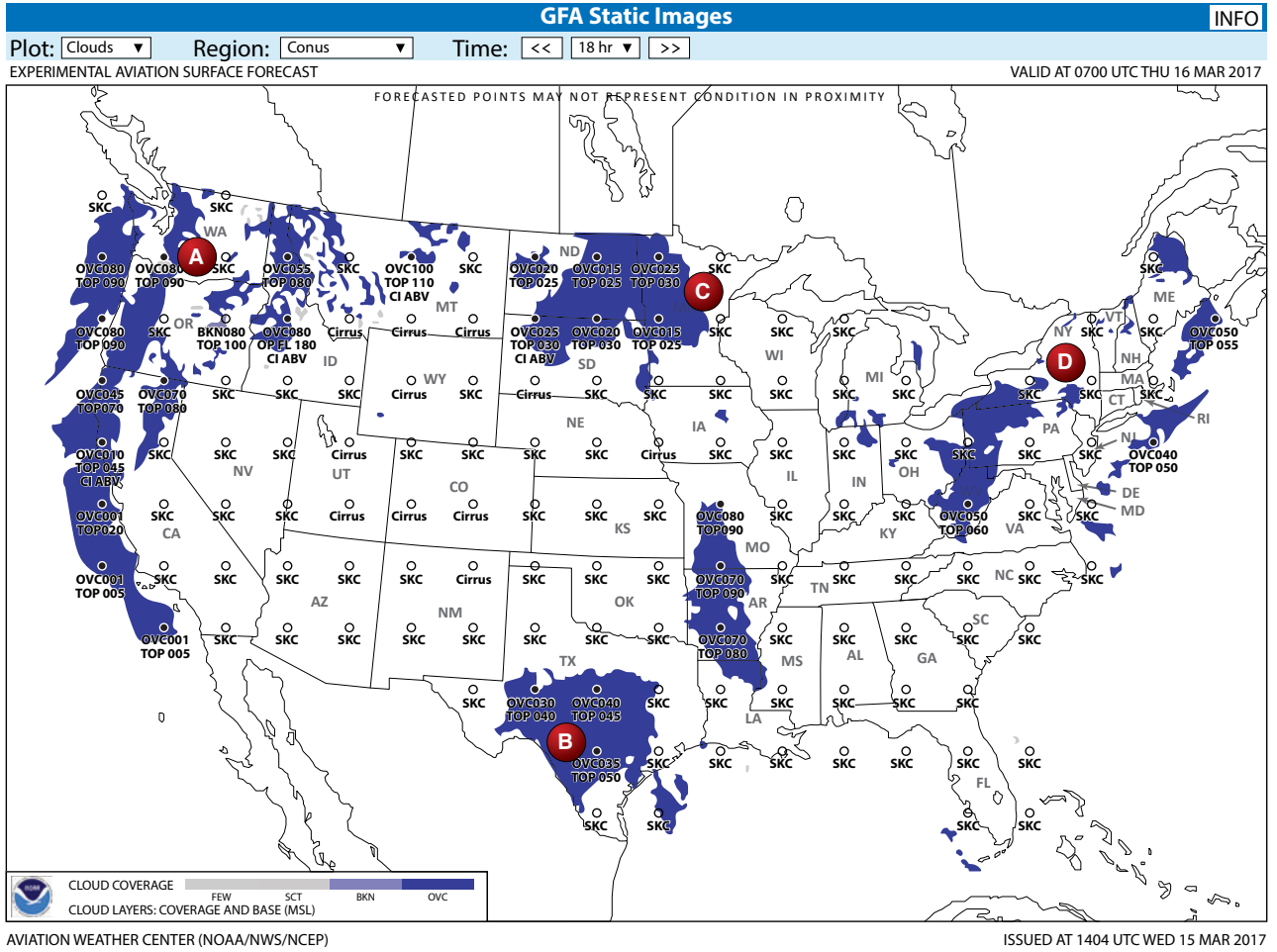

FIGURE 265.—Graphical Forecast for Aviation.

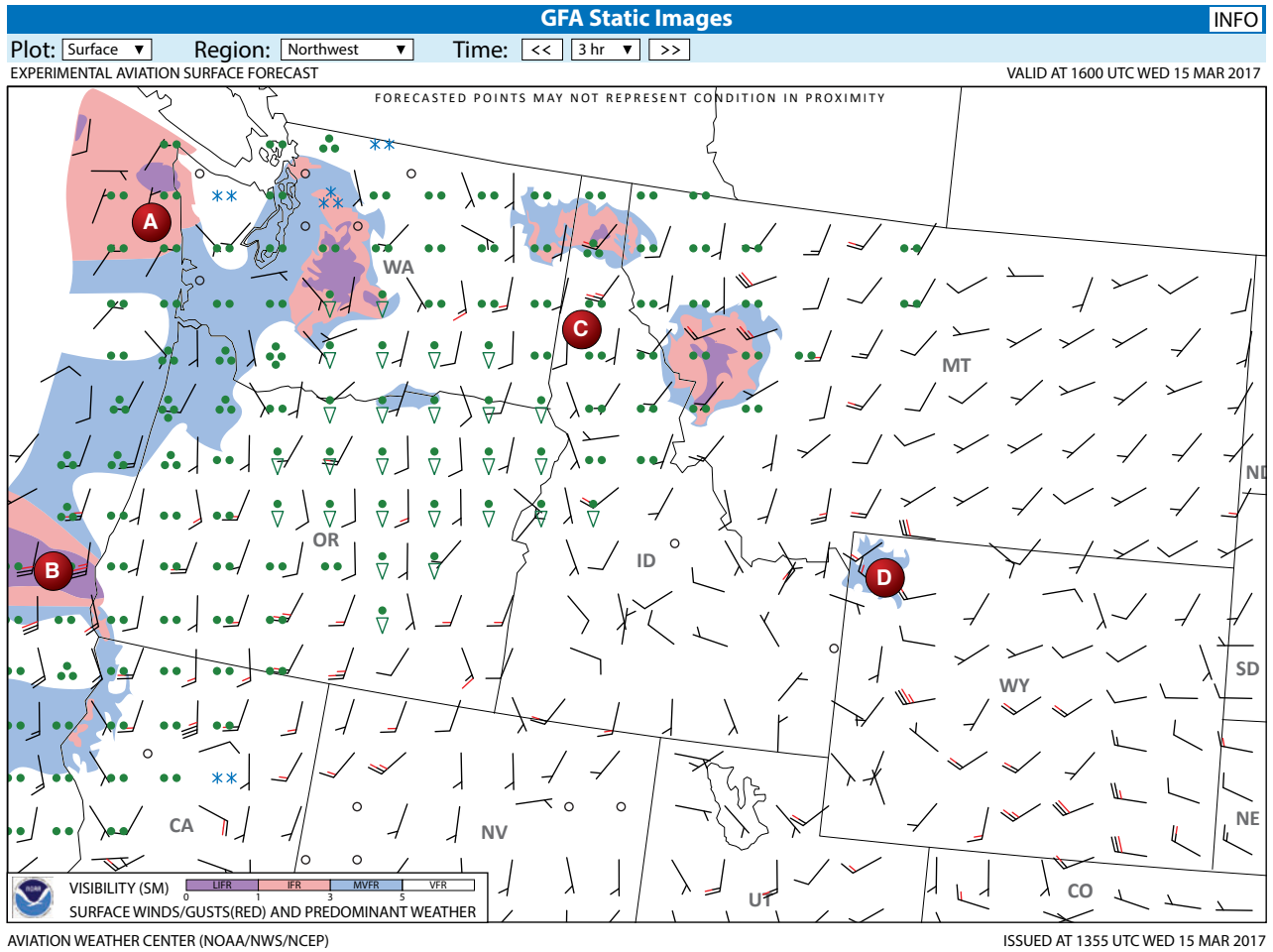

FIGURE 266.—Graphical Forecast for Aviation.

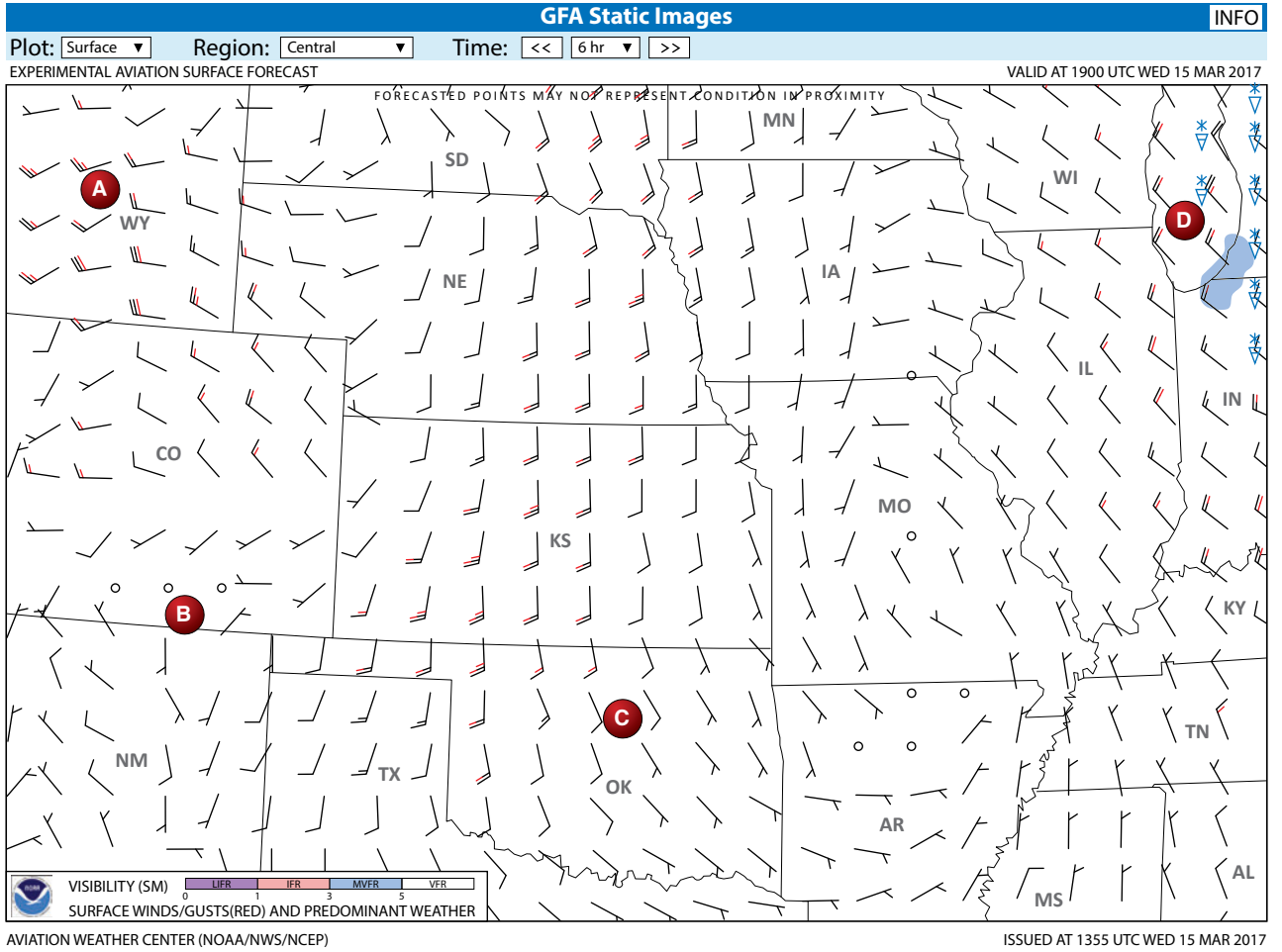

FIGURE 267.—Graphical Forecast for Aviation.

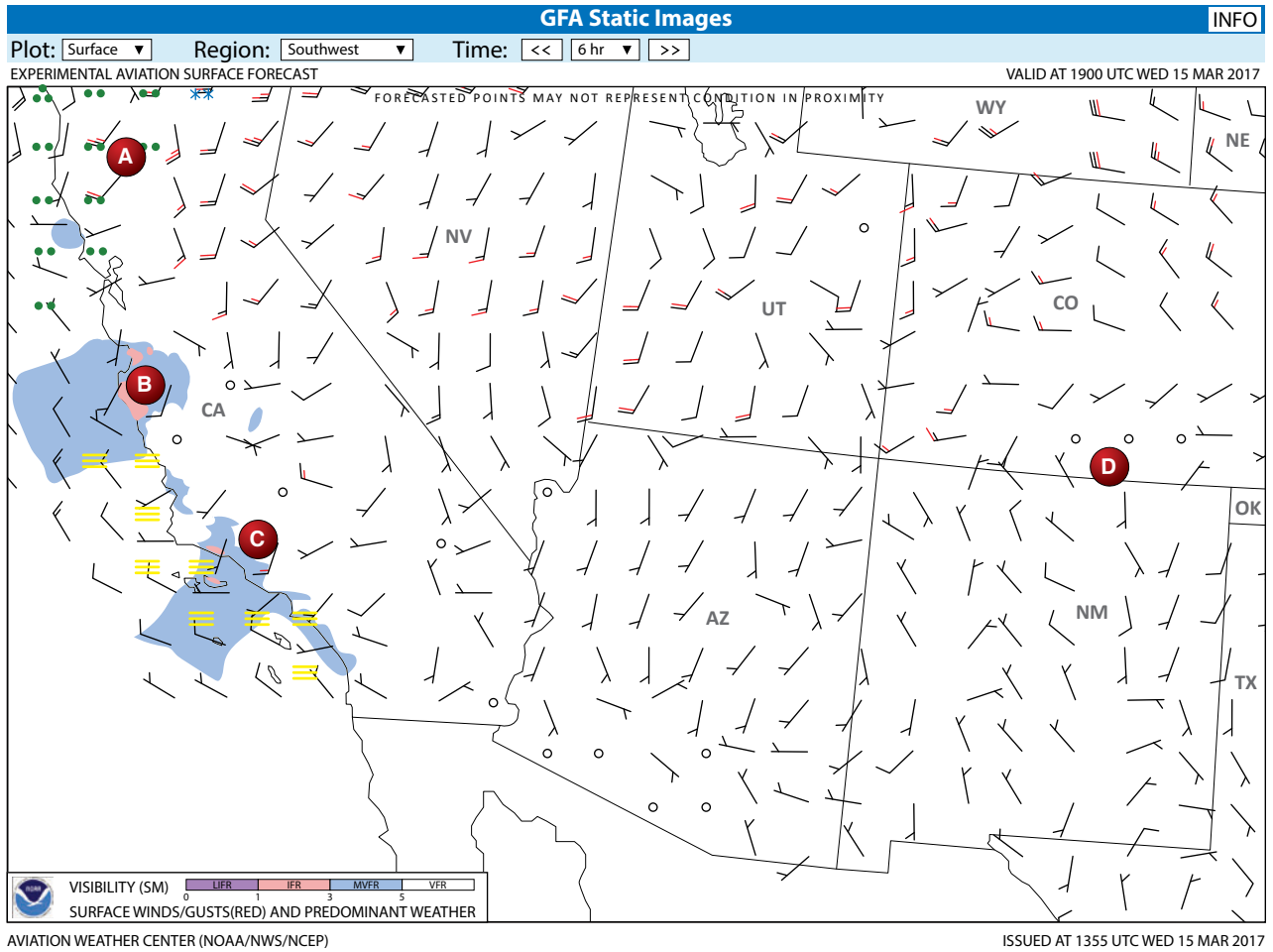

FIGURE 268.—Graphical Forecast for Aviation.

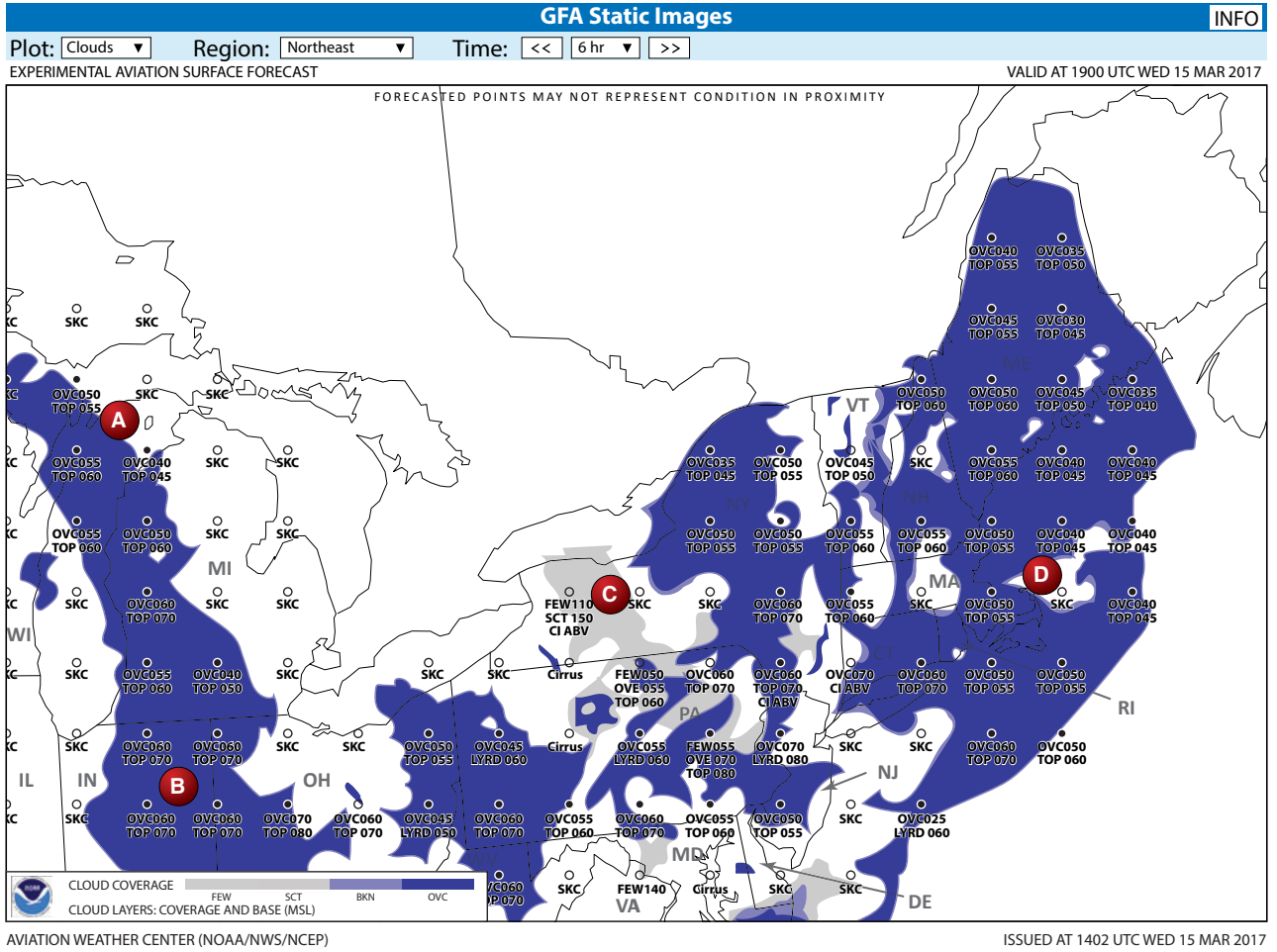

FIGURE 269.—Graphical Forecast for Aviation.

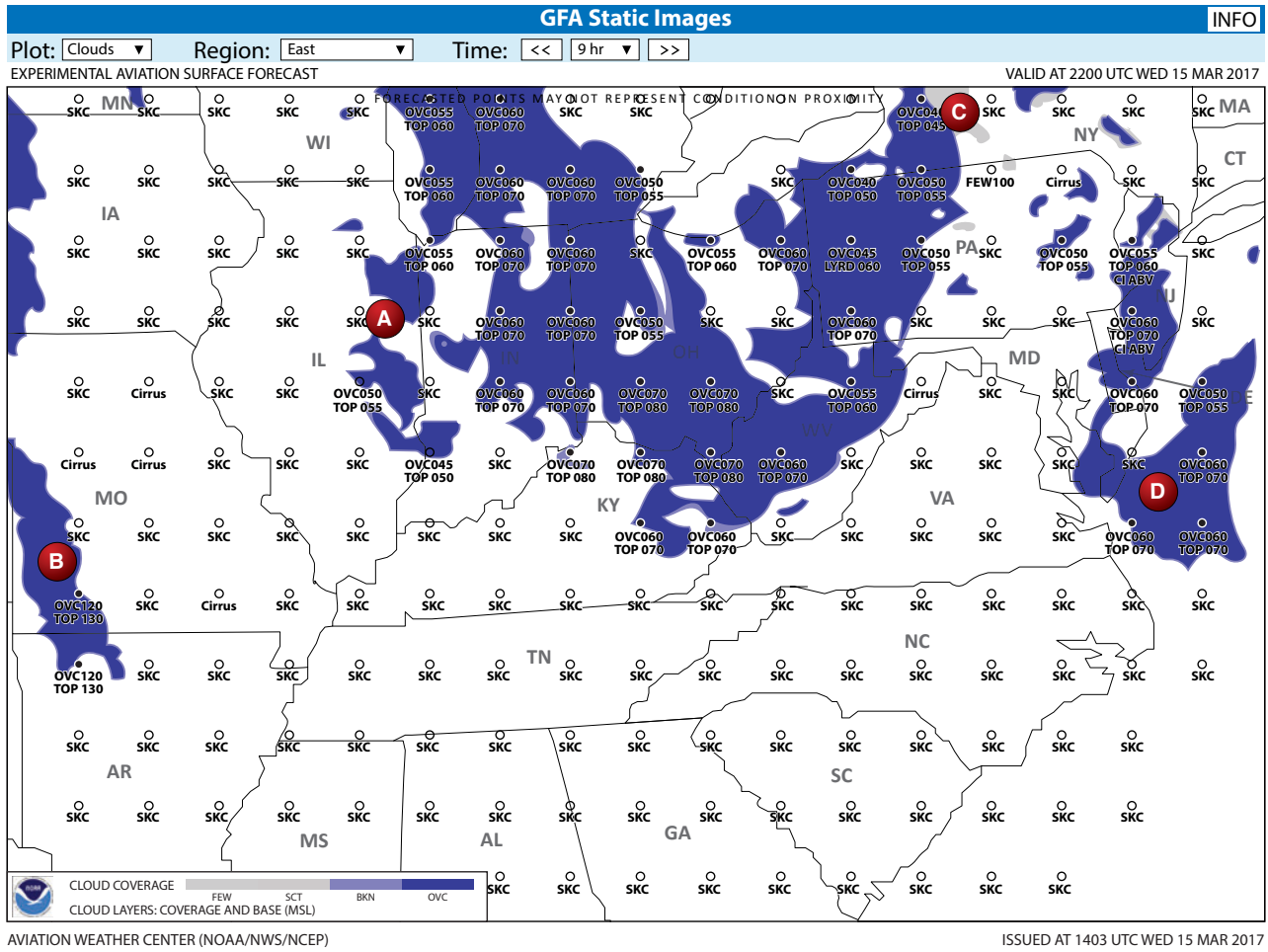

FIGURE 270.—Graphical Forecast for Aviation.



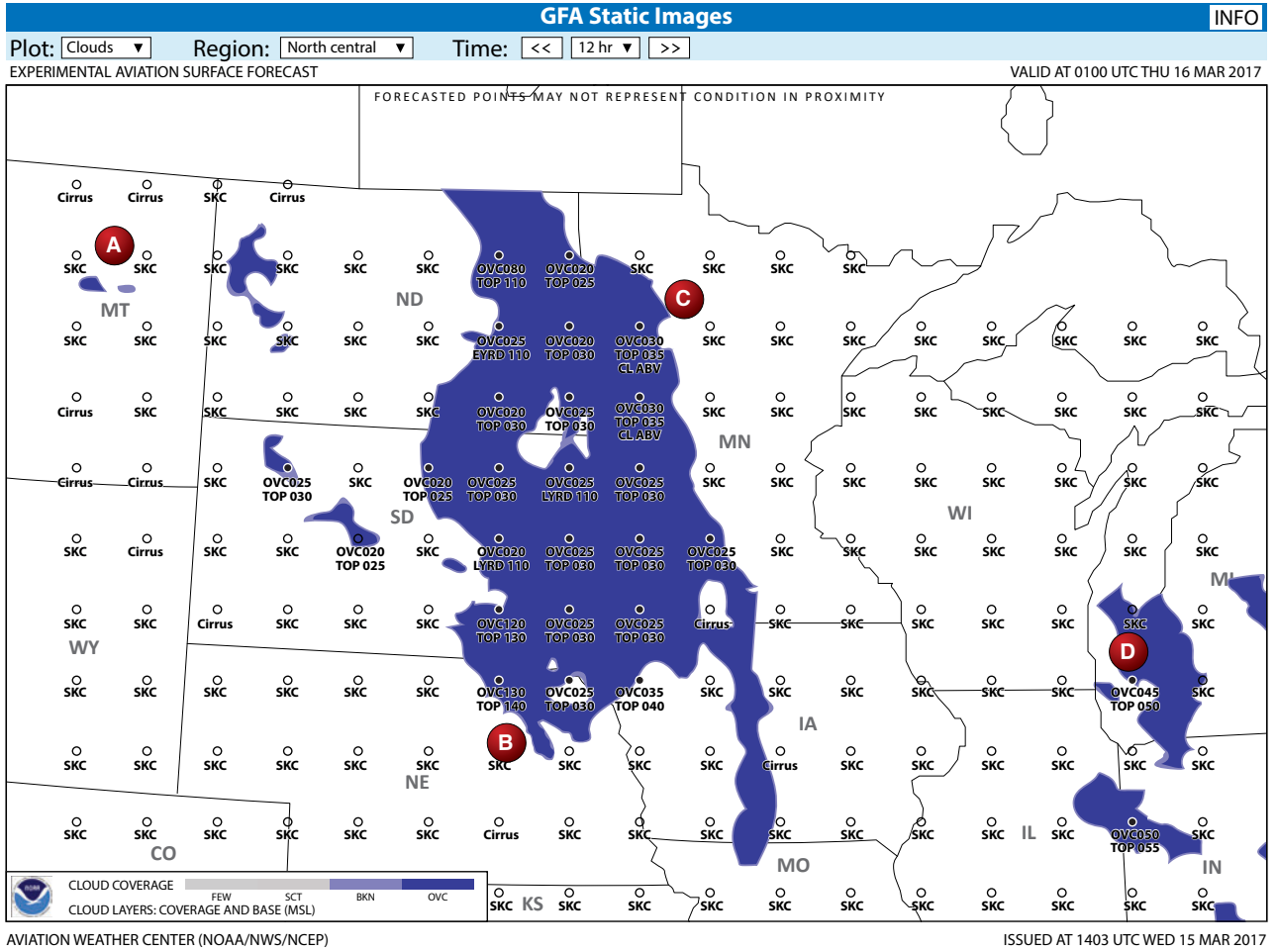

FIGURE 271.—Graphical Forecast for Aviation.





